

# **Proceedings** **of the** **Ocean Climate Data Workshop**

**February 18 - 21, 1992**

Compiled by:  
James Churgin

**Hosts:**

U.S. National Oceanic and Atmospheric Administration  
National Aeronautics and Space Administration

**Sponsors:**

Commission of the European Communities  
International Council for the Exploration of the Sea  
International Council of Scientific Unions  
Intergovernmental Oceanographic Commission of UNESCO  
World Meteorological Organization



Goddard Space Flight Center  
Greenbelt, Maryland, USA

Proceedings  
of the  
Ocean Climate Data Workshop

February 19-21, 1992



This document is produced from art and papers as received from the authors;  
it has not been edited.

## Table of Contents

---

Dedication .....	1
Prologue .....	3
Acknowledgments .....	5
INTRODUCTION TO THE WORKSHOP .....	7
Introductory Speakers .....	9
The Constancy of the Ocean .....	11
The Earth Observing System .....	17
Global Observations and Operational Oceanography: A Decade of Transition ...	19
The Role of Ocean Climate Data in Operational Naval Oceanography .....	27
International Organisation of Ocean Programs—Making a Virtue of Necessity ..	45
Role of the Ocean in Climate Changes .....	51
The Role of the World Data Centers in Handling Ocean Climate Data .....	65
MONITORING CHANGES IN THE OCEAN AND ATMOSPHERE .....	75
Introduction .....	77
The Global Ocean Observing System—One Perspective .....	79
Operational Seasonal and Interannual Predictions of Ocean Conditions .....	85
World Ocean Circulation Experiment .....	87
The Global Ocean Observing System .....	95
Global Temperature and Salinity Pilot Project .....	97
Indian Ocean Analyses .....	109
Satellite Monitoring of the Global Ocean Surface During 1987–1989 .....	131
The Use of Remotely Sensed Data for Operational Fisheries Oceanography ....	145
OCEAN PC and a Distributed Network for Ocean Data .....	153
Sea Level Variation .....	161
DATA ARCHAEOLOGY .....	163
Introduction .....	165
Ocean Climate Diagnostic Studies .....	167
Satellite Altimetry .....	169
High Resolution Modeling of the Global Thermohaline Circulation .....	171
Data Archaeology at ICES .....	173
Data Availability and Data Archaeology from the Former Soviet Union .....	187
Ocean Climate Data for User Community in West and Central Africa: Opportunities and Challenges .....	193
EFFECT OF CHANGE IN THE OCEAN AND ON THE LIFE CYCLE .....	201
Introduction .....	203
The JGOFS North Atlantic Bloom Experiment: An Overview .....	205
Data Management for JGOFS: Theory and Design .....	229

Data Management for Community Research Projects: A JGOFS Case Study ...	251
Management and Assimilation of Satellite Data for JGOFS .....	275
The Continuous Plankton Recorder Survey .....	277
Ocean Time-Series Near Bermuda .....	295
Automated In Situ Observations of Upper Ocean Biogeochemistry, Bio-Optics, and Physics and Their Potential Use for Global Studies .....	317
WRAP-UP SESSION .....	355
Wrap-Up Session .....	357
APPENDIX I .....	365
Program .....	367
APPENDIX II .....	371
Participants List .....	373
APPENDIX III .....	379
International Ocean Services: Is It Time—Will It Ever Be Time? .....	381
APPENDIX IV .....	389
Computer Systems .....	391

## Dedication

---

This Workshop is dedicated to the memory of Henry Stommel. Professor Stommel was a pioneer in almost every aspect of modern oceanography. As in all his endeavors he was ahead of his time in promoting new uses of historical data sets and in stressing the importance of data management schemes that are relevant to the research community. More than 20 years ago he had a vision of a World Ocean Data Display system called a "Live Atlas". At this Workshop we will see some live atlas like computer systems. This workshop will be talking about ways to establish a Global Ocean Observing System (GOOS). Henry Stommel promoted the use of "phantom weather ships" as a means of creating a pseudo observing system. In leading large programs such as the Mid-Ocean Dynamics Experiment (MODE) many years ago he saw the need to create a research based data management group. Today we are looking for models of joint research-data efforts that can be used in climate and other global research. MODE was a model upon which others have built and are still building.

For his contributions to oceanographic data management, to oceanography and to all of science, we dedicate our efforts at this Workshop and in the follow-on work we hope will result. We will miss his leadership.

## Prologue

---

The First Consultative Meeting on Responsible National Oceanographic Data Centres (RNODC's) and Climate Data Services met in February 1988 and made a number of recommendations related to improving services to meet the needs of climate programmes. Included in these discussions was a recommendation for a Workshop on Ocean Climate Data Management. This recommendation instructed the Secretariat to bring the Workshop to the attention of organizations involved with the planning and execution of ocean climate data programmes and requested that an organizing committee be established which would include representatives of these programmes and of international organizations that might be interested in cosponsoring the workshop. The United States offered to host the Ocean Climate Data Workshop (OCDW). The officers of the IOC Committee on International Oceanographic Data and Information Exchange (IOC/IODE) endorsed the OCDW and in January 1990 the first meeting of the OCDW Organizing Committee was held in Washington, DC. The report of the meeting was discussed and approved by IODE-XIII and subsequently endorsed by the IOC Executive Committee. The report of the first meeting included a number of action items and a timetable for completion of these actions. The plan called for a second meeting of the organizing committee to finalize the program, select possible speakers, and set a date for the workshop. The second meeting of the organizing committee was held in January 1991. At this meeting a set of workshop objectives was approved, a basic outline of the programme was developed, conveners for various part of the programme were designated and possible speakers were discussed.

Following the second meeting of the OCDW Organizing Committee, conveners and the committee chairman contacted potential speakers and further refined the programme, keeping in mind objectives that had been developed. The U.S. reaffirmed its intention to host the workshop. Within the U.S. both the National Oceanic & Atmospheric Administration (NOAA) and the National Aeronautics and Space Administration (NASA) planned to host the OCDW. In addition to the support which came from the IOC, the Secretariat was able to get commitments from five other international organizations - the Commission of European Communities (CEC), the International Council for the Exploration of the Sea (ICES), the International Council of Scientific Unions (ICSU), the Scientific Committee on Oceanic Research (SCOR) and the World Meteorological Organization (WMO). Clearly this participation indicates the importance of developing sound data management support for climate research and evolving ocean observing systems. After having completed the programme, invitations were issued to a number of people it was thought represented a good cross-section of the scientific interest groups and data managers working on ocean related climate projects.

The second meeting of the organizing committee resulted in the programme as shown in Appendix I. Objectives of the OCDW were as follows:

- Identify opportunities for improving data management in support of ocean climate research;
- Find ways to improve access to marine data;
- Outline the characteristics of data management systems needed to support ocean monitoring and prediction;
- Provide guidelines for improved data services.

The programme shown in Appendix I may be viewed as having four parts:

- An introductory session of speakers involved with planning for the future, so that participants could keep in mind the types of projects and associated problems that need to be solved in providing data management support for upcoming experiments and programmes.
- A "hands-on" session demonstrating new computer systems recently put in place or which are under development. This was a chance for participants to interact with those developing these systems (see Appendix IV).
- The heart of the programme were three groupings of "Case Studies" in which scientists and data managers summarized findings on recent research projects and discussed data management aspects including recommendations for improvements needed for the future. Case studies were grouped into the following sessions:
  - Monitoring Changes in the Ocean and Atmosphere
  - Data Archeology (Historical Data)
  - Effect of Change in the Ocean and on the Life Cycle (Emphasis on Chemical and Biological Observations)
- The final session - the Wrap-Up Panel - was an open forum in which topics which had come up during the case study and computer sessions were commented on by the participants and a set of issues that need to be addressed were developed.

109 people registered for the OCDW and the vast majority participated in the entire 32 days. Attendees came from 18 countries, 5 international organizations, and many different oceanographic and atmospheric disciplines and interest groups. They were from government, private, and academic organizations. In short, the goal of having a representative cross section of interests was achieved. Appendix II is a list of participants registered for the OCDW.

*Ed. Note: Although all speakers have been asked to provide full edited texts of their remarks, some did not speak from prepared texts or are otherwise unable to have their remarks in time to meet the publishing deadline. These papers will be added as an addendum to these proceedings when they are received. Whenever possible a brief summary or an abstract is included.*

## **Acknowledgments**

---

### ***James Churgin, Chairman, OCDW Organizing Committee***

A workshop such as the Ocean Climate Data Workshop (OCDW) cannot take place without the help of a large number of people. The OCDW was first recommended by Gregory Withee as Chairman of the Intergovernmental Oceanographic Commission's (IOC) Group of Experts on RNODCs and Climate Data Services. Mr. Withee was then Director of the U.S. NODC and is currently Deputy Assistant Administrator for Environmental Data Services. It was under Mr. Withee's guidance that the U.S. offered to host the Workshop and provide funds for all related activity within the U.S. An important aspect of the Workshop was participation by all international organizations with an interest in the subject. Dr. Youri Oliouline, Assistant Secretary of the IOC was invaluable in obtaining the participation of these organizations including provision of travel funds for a number of participants. In addition, the full participation of the World Meteorological Organization (WMO), The International Council of Scientific Unions (ICSU), the International Council for the Exploration of the Seas (ICES), Commission of European Communities (CEC) and the Scientific Committee on Scientific Research (SCOR) contributed much to this endeavor.

The purpose, objectives and program outline were developed at two meetings of the OCDW Organizing Committee. Those in attendance or providing input to these meetings included: Gregory Withee, Sydney Levitus, Bruce Parker & Ronald Moffatt (NODC/WDCA), Bert Thompson (WOCE/IPO), James Crease (WOCE Data Panel), Paul Geerders, Albert Tolkachev, Trevor Sankey, Youri Oliouline (IOC), Nic Flemming (Chairman of the IOC Committee on Oceanographic Data Exchange), Michael Crowe, Joel Martillet (WMO), Stanley Ruttenberg (ICSU), J. Ronald Wilson (MEDS, Canada) and Alain Ratier (CNES, France).

The program was further developed through the untiring efforts of the conveners for the sessions: J. Ronald Wilson, Sydney Levitus, Hugh Ducklow (Univ. of Maryland) and Lola Olsen. Finally, programmatic and logistical support given by Lola Olsen of NASA and her staff is acknowledged with great appreciation as is the support given by Mr. Withee and the staff at NODC especially Robert Gelfeld and Ronald Fauquet.



# **Introduction to the Workshop**

---

*Convener - James Churgin*

## **Introductory Speakers**

---

In order to have participants focus on future needs the introductory speakers described the evolving oceanographic research picture. Dr. Knauss' paper set the entire tone of the Workshop by giving a frame of reference from where we have been to where we are going. Others described specific projects and programmes underway or planned and each stressed the need for a data management effort interwoven into the fabric of the programme. Dr. Webster's remarks tied these ideas together by describing how the World Data Centers were planning for the future. Participants were also provided a number of issues that they might wish to address during the course of the Workshop. Because of time limitations there was a little discussion of these issues during the introductory session, but they were more fully covered at the wrap-up session and during the papers on case studies.

Regrettably Dr. Wilson's notes were not available and he was not able to give us the full text of his remarks. There is, however, a video tape as well as an audio tape, of all these introductory remarks that is available from the U.S. National Oceanographic Data Center.

## **The Constancy of the Ocean**

---

**John A. Knauss**

Forty years ago, when I was beginning my career as an oceanographer, if I had read about an "Ocean Climate Workshop," I believe I would have had little idea of what you were going to discuss other than perhaps updating the Meteor Atlas and building similar atlases for other oceans. I expect that none of my colleagues would have guessed. Perhaps you were going to talk about how to tell the good data from the bad data so that one could derive better and more reliable charts of the average distribution of properties.

To learn that you were going to discuss the documentation of, and how to measure, small, but significant changes in the ocean climate over a time span of less than a century would have been surprising. It would have been more than surprising; it would have been shocking. The ocean was constant once you got below a shallow wind driven depth. That was the accepted dogma. Measurements made one year could be combined with those made twenty years later to provide a satisfactory mean picture. Any yearly variations in the spatial distributions of temperature and salt was attributed to poor salinity titrations, bad reversing thermometer calibration, or simply sloppy work by inexperienced scientists and technicians. In fact, such attributions were often correct.

The classic example of this approach was that of Wust who in 1924 took the wonderful set of current measurements in the Straits of Florida made by Lt John Pillsbury during the four year period 1885-1889 and compared them with geostrophic calculations made by combining temperature measurements from the same region by Bartlett a decade earlier and salinity observations made 30 years later. The agreement between the observed currents of Pillsbury and the calculated geostrophic currents was excellent. I know I was impressed when I came across this work in reading *The Oceans* shortly after World War II, as I expect were most of my colleagues as they began their careers.

The concept of the constancy of the ocean was deeply ingrained. The systematic collection of surface currents and surface temperature along with surface weather observations was a tradition of all early exploratory expeditions and was systematized internationally a century and a half ago by Mathew Fountaine Maury of our US Navy, but once detailed monthly charts of surface winds, currents and temperature were available, there was little enthusiasm on the part of Maury's successors to go looking at year to year changes. One knew one had to treat the surface wind charts in some simple statistical manner since it was obvious that the winds could and did change from day to day.

It was also assumed that those same varying winds added some small variability to the surface currents. There was even some limited evidence that after a particularly strong wind you could observe surface currents moving in an inertial circle. But once you got below the shallow, wind influenced surface layer, all was steady and constant. The ocean climate was invariable. I remember about 35 years ago discussing with Fritz Fuglister his IGY program in which he was going to repeat the Meteor sections of the early twenties to see if he could find any significant changes, and I recall thinking that was not a very imaginative program, and being a bit disappointed because his Gulf Stream work was so exciting.

Our meteorological colleagues on the other hand made no such assumption about the constancy of the atmosphere. Of course, they had the advantage of stationary, fixed observation stations, from which they were quick to document that one year was not like the last, a proposition than any farmer, gardener, or reasonably observant person can at least qualitatively attest to.

At least as important, they had a large signal to observe. There are large swings in temperature and precipitation from one year to another. They also had, and still have some relatively easy surrogates for climate change; the date lakes freeze and break up, the growth and retreat of mountain glaciers. We who study the oceans have nothing similar, or if we do I am not aware of them.

Until recently there has been little enthusiasm for systematic ocean observations, some of the programs of ICES and the Calcofi program being notable exceptions. Those tide station records and a few surface temperature records at shore stations, are about the limit of systematic records of ocean properties over time spans of more than 25 years.

Furthermore, until quite recently there have been few attempts to take the non-systematically collected data from the ocean archives and data centers and attempt to fashion anything other than climatic atlases of the mean. As might be expected, the first to do so, at least as near as I can recall, were meteorologists, people like Jacob Bjerknes and Jerry Namais, the former who looked at the very non steady state El Niño phenomena and the latter who used surface temperature anomalies in the North Pacific as input to his seasonal forecasts of North American weather.

In retrospect it is difficult to understand why oceanographers were so slow to accept a non-steady state ocean. Conceptually, the ocean atmosphere interaction linkage has been known for a long time. You can ignore that interaction for atmospheric forecasts as short as a few days; you cannot ignore it if you wish to understand the year to year changes in the seasonal weather. Since there is ample evidence of significant year to year changes in our weather, one would assume there are year to year changes in our ocean "weather."

As one reasonably active in the field during this period, I have thought recently about this question of why we virtually ignored the study of year to year

variability in our ocean climate, and I am not very satisfied with my answer. It falls into two parts. Meteorologists had neither the computer power or the models to make use of this information if we provided it, so the subject had little urgency. As important, we oceanographers had no adequate observing system to collect and document the changes, and no adequate hypothesis around which to design a system which one instinctively knew would be very expensive and labor intensive.

So, like most scientists we concentrated on the solvable problems, and if we thought about the variable ocean at all, we remembered Wust and his calculations of the Florida Current.

MODE and POLYMODE taught us that the ocean is much more energetic than we had assumed, although a few like Henry Stommel had been convinced for some time. With increased energy came observations of increased variability. First there were the Gulf Stream rings, first documented in the early fifties, but not much studied thereafter; now there are rings everywhere, both sides of the Gulf Stream, in the Indian Ocean and Antarctica. Then came the wonderful infrared pictures of the Gulf Stream, chaotic and complex beyond anything in Fritz Fuglister's active imagination; now we see that level of complexity in satellite pictures almost everywhere we look. More recently we have the Southern Oscillation of the equatorial Pacific; and for the first time a testable hypothesis of ocean-atmosphere interaction on a global scale.

We are badly in need of a global ocean observing system. The ocean is not constant. It does change, and we need to monitor those changes, but I am not yet satisfied we know what to monitor and at what scales. Perhaps more precisely, we don't know what we can afford to monitor. In spite of the magnificent improvements in instrumentation since I was active in this field, ocean observations are not cheap. We must choose our system carefully and wisely. Designing such a system is both a challenge and a priority to NOAA and to the international community of scientists interested in climate change.

That challenge has many dimensions, one of which is data continuity. The meteorological community has orders of magnitude more historical data than do we, but they have been struggling these past few years searching their records for temperature or other signals in an attempt to document global warming. It has not been easy.

Almost all of the meteorological data has been collected for those who need the information immediately, mostly as input to the daily forecast. The daily forecast is built primarily on measuring gradients, the difference in pressure, temperature, cloudiness or rainfall between locations.

There has been relatively little concern in the past about small temporal changes when an observing station is moved, or when the environment changes around the station; the measurable increase in temperature over time in urban weather stations for example which is a result of heat generation in urban areas

and not necessarily global warming.

As many of you know it has been equally difficult to document change in ocean surface temperature as the method of observation changed from placing a thermometer in a canvas bucket of freshly drawn sea water to reading the temperature of the engine cooling water as it enters the pipe on the side of the ship.

It is essential that whatever global ocean observing system we build, we include in its specifications the need not only to provide useable data to those with an immediate need, but to ensure that those who come after us can use that same data to plot temporal trends. One should not underestimate the problems inherent in this requirement. As we use more and more indirect methods of observations, the whole array of satellite sensors for example, this issue will become of ever more importance.

The ideal way to track trends, of course, is to use some form of integrating measurement; but these are not easy to find. A retreating alpine glacier could be global warming, but it could also be a signal of reduced precipitation.

Walter Munk believes he has found one such integration scheme. Sound velocity increases with increasing temperature. Thus, everything else being equal, the time it takes for sound to travel between two fixed points will decrease as the temperature of the ocean increases. As we know everything in the ocean is not equal, but Walter and his colleagues have looked at all of the complications and have concluded that if the technology is equal to the task, timing the arrival of sound waves is a good means of tracking the temperature of that part of the ocean between source and receiver.

Based on experiments this past year where coherent transmitted sound was received half way round the world it appears that the technological problems may be tractable. But now we have now come full circle. Forty years ago it was the accepted wisdom that any changes in ocean structure below the shallow surface layer were small, and probably steady. Forty years ago one would have said that if Walter Munk's experiment failed it would be because of technology and not because of the ocean.

It now appears that we have the technology to conduct the experiment. One of the few remaining questions is the constancy of the ocean. Is the heat content variability sufficiently large that one will be required to measure as many years in the ocean as on land to extract the small increase in the mean temperature of the ocean from the large year to year changes in the heat content of the different ocean basins? We expect not, but we are no longer as confident as we were a mere twenty five years ago.

We have entered a new era of oceanography. We can begin to look for the year to year changes in the ocean. In the case of the Southern Oscillation of the equatorial Pacific we have a glimmering of how large scale ocean-atmosphere interactions work. I expect we will soon have more examples. Careful observations of the ocean, more systematic observations of the ocean, well archived observations of the ocean will become of increasing importance. This ocean climate workshop is timely.

## **The Earth Observing System**

---

***Stanley Wilson***

### **Summary**

The talk began by describing the progress that had been made in developing instruments, observational techniques and algorithms for deriving satellite based oceanographic observations. Much of this early work used basic measurements from SEASAT and then many years of work to arrive at agreed upon algorithms. A number of standard products now available were illustrated. The Earth Observing System Data & Information System (EOSDIS) Pathfinder Program will make many of the existing data sets available to the research community for the cost of reproduction. EOSDIS will also act as a archival conduit for missions such as TOPEX and NSCAT. Charts were presented to depict planned and proposed ocean oriented satellite missions for altimeters, scatterometers and color scanners over the next decade.

The talk went on to describe work that was needed in order to plan for a Global Ocean Observing System (GOOS). This includes answering questions on the spacial and temporal scales needed for monitoring as well as the types of measurements that will be required for a monitoring program. Work is underway for development of a monitoring system for El Niño/Southern Oscillation (ENSO). Also work is being done on the role of drifters, on economic impacts of GOOS and on inter-decadal variability.

There is a need to focus on the tasks required in order to properly integrate satellite and in-situ observations as use this in developing follow-on programs to WOCE, TOGA and JGOFS. Eventually we need to use all these techniques in providing data to drive forecast models. The talk also stressed the need to develop GOOS as an international partnership within the existing international organizations.



## **Global Observations and Operational Oceanography: A Decade of Transition**

---

### ***D. James Baker***

I am happy to be here and especially pleased to see that the workshop was sponsored by IOC and held at Goddard, because these two organizations represent much of the future for ocean science. IOC in that international cooperation is essential for monitoring and understanding the health of our environment, and Goddard because of its long-term role in developing new technology, particularly satellite measurements of the Earth and new data systems. I'm very pleased to see Vince Salomonson and Gunnar Kullenberg here today, because their leadership at Goddard and IOC is guiding us toward the technology and international cooperation we need for a global observing system.

John Knauss and Stan Wilson have done a fine job in explaining the science and technology that has led us to the state today where an operational observing system is in sight for the ocean. John showed us the lack of understanding of the science of the ocean and how we must have more observations if we are to measure its state, monitor changes, and provide the data that is necessary for predictive models. Stan showed us just how far we have come in developing technology that can provide such observations, from satellite systems to new in situ systems. On behalf of the ocean community, I would like to thank both John and Stan for the hard work that they have done on behalf of the community in NOAA and NASA and now together in NOAA to make long-term observations of the ocean a reality.

The next two speakers that follow me will talk about aspects of this new world, Admiral Chesbrough from the U.S. Navy on a user's perspective and Angus McEwan on international organization. The rest of the workshop will focus on specific science and technical aspects of ocean climate data, and so I will not try to talk about any of those. Jim Churgin and Greg Withee have done an excellent job in putting this agenda together; I think it will give you a good sense of how ocean climate data and the techniques which are now available are central to providing the information that we need.

This past year we lost two of our most famous oceanographers, Roger Revelle and Henry Stommel. Each was involved in the grand issues of global observing systems; Roger having set the stage for the Keeling CO<sub>2</sub> monitoring program and starting most of the international organizations that we now have in place. Henry was always concerned that whatever we did, it made scientific sense. "Why do our ideas about ocean circulation have such a dreamlike quality" was the title of one of his unpublished papers; the answer of course being that we didn't have adequate

measurements. He was emphatic in his insistence that observational systems be designed in accordance with the physical processes that actually occur.

In a speech to the Oceanography Society in 1988, Henry said: "Looking into the future beyond twenty years of WOCE, I think that we will see the establishment of a regular oceanic data network, using remotely controlled vehicles to make routine subsurface measurements, on a global scale, like that of the meteorological network. Presumably such regular data-collecting systems will eventually be taken over by responsible government agencies, and the research community will be relieved of taking much of these climate-motivated data. They will feed the hungry computers."

Then he wrote, in another unpublished paper on "General Principles for the Design of a World Ocean Observing System": "By the year 2000 we can anticipate that, as a result of ongoing process field studies and sophisticated numerical predictive, eddy-resolving models of ocean circulation, it will be possible to maintain an up-dated "state of the dynamics of the ocean" model which can be used for predictive purposes, making perhaps one month forecasts of eddy events, and longer forecasts for events such as El Niño, anomalies of deep and intermediate water formation, spreading of pollutants, and so on."

"It should be emphasized that technological development, process oriented research, monitoring, and modelling are joint and necessarily coexisting and mutually supportive efforts. They all must be called upon to build a WOOS." Stommel concludes his paper by saying: "What a magnificent opportunity it can be for an enterprising nation to present a GOOS as a gift to an environmentally distracted world!"

Where do we stand in making this happen? Let's look at some history: In the 16th and 17th centuries, Spain and Portugal led the way in geographical exploration. In 1795, Great Britain's Hydrographic Office assumed the immense task of systematically surveying the coasts and islands of the world under the direction of the Hydrographer Alexander Dalrymple. In 1853 the American Matthew Maury persuaded maritime nations to begin systematic collection of surface data that led to his "wind and current charts" which benefited the commerce of the age of sail.

Leaping to fast forward, in 1969, the Panel on Environmental Monitoring of the Stratton Commission on Marine Science, Engineering and Resources, chaired by John Knauss, noted that: "New requirements for real time monitoring of the ocean and atmosphere, and predicting their changes, make it vital to the National interest that we take firm steps toward the establishment of a comprehensive global oceanographic monitoring and prediction system, in concert with other nations. The potential benefits to all marine activities, as well as land-based activities, are substantial — in improved warning of ocean and weather hazards to life and property, support to marine transportation and resource development, and enhancement of national security."

The Panel recommended that: "The Nation's oceanographic monitoring and prediction activities should be integrated with the existing national weather system as well as certain aspects of the solid Earth to provide a single comprehensive system, which the Panel has identified as the National Environmental Monitoring and Prediction System". The Panel hoped that the decade of the 1970s could be used to develop technology that could be introduced at low cost for global monitoring and that by 1980 the next-generation system would be in place to provide adequate data coverage and services to meet national needs.

But, as you are all well aware, we don't have a global environmental system in place today. We have a set of essentially uncoordinated and underfunding activities that falls well below a critical effort. In fact, the Second World Climate Conference recognized this lack, and called for the establishment of a Global Climate Observing System in 1990. The Conference noted that present observational systems for monitoring the atmosphere, cryosphere, land surface, and oceans are inadequate for understanding and predicting climate change. Following that call, a scientific and technical committee has been established and a planning office has been set up in Geneva. So there will be some action.

I think that the time is right for the formalization of these ideas about a global ocean observing system. I think we are ready for a decade of transition from research to operations, as proposed by the Knauss Panel, it's just that it is happening 20 years later. That's not a bad time delay considering the complexity of the system in which we live. Think about the global weather observational system, called the World Weather Watch and coordinated by the World Meteorological Organization.

The first recorded international collaboration in meteorology was in 1853 when a group of seafaring nations drew up a program to obtain weather observations over the oceans with the aim of contributing to safety of life at sea. At about this time, countries began to establish national Meteorological Services and the International Meteorological Organization was established in 1873. The creation of the United Nations in 1945 provided a new framework for international collaboration in technical and scientific fields. The World Meteorological Convention was adopted in 1947 and in 1951 the new intergovernmental World Meteorological Organization was created to replace the old non-governmental IMO. Later that year the WMO became a part of the UN.

In 1961 the WMO proposed a "world weather watch" which combined satellite and conventional observations, a network of world and regional weather service centers, and a telecommunication system. At the Fourth WMO Congress in 1963, the World Weather Watch was established, 110 years after the first proposed international measurements in 1853. The World Weather Watch Plan was approved by the Fifth WMO Congress in 1967, with three components: the Global Observing System, the Global Data-Processing System, and the Global Telecommunication System. It was designed as a flexible, evolving system, allowing the incorporation of new technology and techniques as a more or less continuous

process. To assist countries less able to contribute to the global system, a Voluntary Cooperation Program was established. All of these aspects of the program are still valid today.

Looking at the development of the World Weather Watch, we can see that our progress from the ocean side is not so slow. As John Knauss pointed out, we are just learning now about how the ocean works. As Stan Wilson noted, we only now, in this decade, have a full set of satellites measuring physical and biological variables key to climate and global change. So this is the decade of transition.

What are the impediments that we much watch out for? First it would be useful to have a definition of operational. From the Concise Oxford Dictionary, 1990, we see that "Operations" is defined as: "The state of being active or functioning (as in "not yet in operation"; "An active process; a discharge of a function"; "A piece of work, especially one in a series." Operational is defined as "Engaged in or involved in operations; able or ready to function."; and an "Operator" as a person acting in a specified way. All of these definitions are different from research, especially the last one. Operations are routine, research the opposite of routine.

These definitions are put here to remind us that operations is different from research. We have been in a research mode for a long time, and we will have to learn a new a way of doing business. We can also extend the definition to include: "long-term systematic measurements of the ocean."

How do we get a system established? The strategy for the implementation of such an operational ocean observing system begins with the enhancement of existing operational measurements, the support of global-scale climate-related research programs such as TOGA, and the development of new observational technology. As these are combined with modeling developments we hope to be able to move towards an affordable operational system that could be a major element of any future international effort. The workshop sponsored by NOAA and Navy last September in Alexandria was aimed at identifying the major issues of design and operation and next steps that can be taken in the U.S. for such enhancement:

1. **Support Existing Climate-Related Programs.** The initial program must build on existing regional and global climate programs. This ensures adequate input of scientific information and the continuation of time series vital to the development of climate data bases.
2. **Start an Early Technology Development Program.** An early start on the development of more capable and cost-effective in situ platforms and sensors is essential. Maximum use of satellite systems is essential for global data sets.
3. **Long-term Technology Development.** A long-term technology program is also essential, including autonomous vehicles, acoustic techniques, and new satellite techniques. The development of low-cost instruments and expendables to encourage participation by developing nations and interactions with changing computer and communications policy is an important aspect of this activity.

4. **Establish an Interagency Coordinating Mechanism.** The initial steps in Federal Agency organization must be taken to set down plans for oversight, funding, and operational planning. A lead agency will be required.
5. **Develop a Plan for a U.S. Contribution to an International Global Ocean Observation System.** The initial plan can be a network of what the Federal Agencies now support guided by a plan to combine future efforts with other activities from other nations; the whole coordinated by an international plan.
6. **Interact with the National and International Scientific Community.** A truly global ocean observation system will be joint national, including the academic institutions and the government, and the private sector, and an international effort. Much planning and agreements from funding to measurement and access protocols will be needed.

National coordination that involves the academic institutions is key. JEDA is one example; there are others.

The international aspect is key to success as with WWW. To address these issues, the international community has begun a long-term planning effort. The SCOR/IOC Committee on Climatic Changes and the Ocean (CCCCO) and the WMO/ISCU Joint Scientific Committee for the World Climate Research Program are jointly sponsoring an Ocean Observing Systems Development Panel that is starting the process towards design of a global system. The OOSDP is being assisted in this task by the Ocean Processes and Climate Committee of the Intergovernmental Oceanographic Commission. In all of this planning it is recognized that strong national efforts by the operational agencies will be required to support the international planning. The workshop was the first step in the U.S. to start this process towards a strong national activity.

A topic that is under discussion in several parts of the U.S government now is the release of previously classified data. One area of general interest to oceanographers is navigation. Aside from its uses in the practical world of positioning ships, aircraft, and commercial transportation, precise positioning is an aspect of scientific measurement that cuts across many disciplines. For example, the DMSP passive microwave data are less useful than they could be because of the poor quality of its navigation data that are furnished to the civilian community. At present, the real-time absolute positioning capability of a few centimeters from the multi-satellite Global Positioning System is not available to users outside the defense community when "Selective Availability" is operative. But the precise measurements are key elements for navigation, accurate tracking of satellites, for surveying, and for land and ocean topography measurements. The irony of the fact that the precise data were declassified during the Persian Gulf war because of lack of availability of classified receivers was noted — the limited access system works best in peacetime! Selective Availability still allows differential positioning, thus for geophysical applications involving crustal movement, the scientific measurements can be carried out. The discussion considered delayed release of precise navigation data, but this was generally felt not to be as useful as immediate availability.

Of special interest to this workshop are Information Systems. Data management is everybody's second priority. But if quality data is not available to researchers and analysts a decade after the start of a global ocean observing system, the effort will be a failure. The data management effort must receive international attention and agreement if the resources of all nations are brought to bear on a global ocean observation system. Data links from operational sensors to national centers must be identified, protocols for archival, communications and networks planned and agreed to and resources made available to support this effort.

Fortunately the WMO and the established protocols and communications links developed for worldwide meteorological data can serve as a guide. Additionally much experience has been gained through incorporation of data management fully into such programs as TOGA, WOCE and JGOFS. Incorporation of biogeochemical information into such a system may draw on the experience of the medical community. And we are given hope by the emphasis on a Data and Information System that will be part of the Earth Observing System. Goddard has led the way in the development of data systems for space missions, and I expect that you will see much of this in the next few days.

#### **Finally, we consider issues of Coordination and Oversight.**

If the observational program resides in more than one federal agency, joint management will be needed, and this is not easy to carry off, in any government. Agencies are jealous of their prerogatives, and here we also will have the academic institutions involved. As mentioned previously, the scientific community has strong feelings that they should be involved in some way in the management and data collection or at least quality control aspect of data collection and processing. On the international scene the WMO may be a model system to be emulated with a special difference: a close connection between academic institutions and operational groups. This tuning for the special needs of the ocean community draws on the experience of the community and will benefit both sides.

Long term funding for the effort must be arranged. But these programs are not easy to sell to a skeptical agencies and legislative bodies. This reminds me of the bear, who, displaying a five dollar bill, entered a bar and ordered a beer. The owner of the bar directed the bartender to give the bear a beer, saying that since the bear didn't look very smart, to give it only 25 cents in change. Having done as he had been instructed, and having watched incredulously as the bear placidly sipped the beer, the bartender finally no longer could contain himself and sought to engage the bear in conversation. "You know", he said, "we don't get many bears in this bar." To which the bear replied, "At \$4.75 a beer, it's no wonder."

In June, the United Nations Conference on Environment and Development in June in Brazil is expected to be a forum for heads of state to deal with a wide variety of issues ranging from coastal pollution to global warming, biodiversity, lives.

On the world scene there have been bigger events: the dismantling of the Berlin Wall, Persian Gulf war, and the collapse of the Soviet Union and the end of the cold war. In a recent article in the New York Times, Leslie Gelb noted that we all grow so jaded by the constant proclamations of new eras and new beginnings that we seem to have trouble recognizing the real thing when it finally arrives. But a new era is indeed at hand, and the opportunities are great: the end of the cold war gives us an opportunity to relook at our entire military budget, our intelligence apparatus, and the way in which we, and especially our Navy, does business. We will hear more about that from Admiral Chesbrough.

So there is hope for the future, although we should temper that optimism with Norm Augustine's advice: "If today were half as good as tomorrow is supposed to be, it would probably be twice as good as yesterday was!"

# The Role of Ocean Climate Data in Operational Naval Oceanography

---

*G.L. Chesbrough*

## **Abstract**

Local application of global-scale models describes the U.S. Navy's basic philosophy for operational oceanography in support of fleet operations. Real-time data, climatologies, coupled air/ocean models, and large scale computers are the essential components of the Navy's system for providing the warfighters with the performance predictions and tactical decision aids they need to operate safely and efficiently. In peacetime, these oceanographic predictions are important for safety of navigation and flight. The paucity and uneven distribution of real-time data mean we have to fall back on climatology to provide the basic data to operate our models. The Navy is both a producer and user of climatologies; it provides observations to the national archives and in turn employs data from these archives to establish data bases. Suggestions for future improvements to ocean climate data are offered.

## **Slide 1 - Introduction**

**Think Globally . . . Act Locally.** This slogan, seen on automobile bumper stickers and popular among environmentalists, aptly describes the U.S. Navy's philosophy when it comes to oceanographic support for fleet operations. The Navy's mission is worldwide, but at any given moment, the local environment dominates the operations of every naval component at sea. This fact of life shapes our approach to fleet support. The realization that no organization possesses the capability, or the resources, to satisfy all of the data and information needs on demand, leads to the heavy reliance on ocean climatologies to drive the models that provide the nowcasts and forecasts that are so important to naval operations.

## **Slide 2 - The Process**

There exists a "Process" in operational Naval Oceanography whereby we get from Point A to Point B. That "Process" starts with Data Sources — Space-based, Earth-based, and Data Bases, both real time and historical. These Data Sources feed the Coupled Air/Ocean Models that provide the Operational Systems Performance and Prediction Data, and Tactical Decision Aids. These products go into making Warfighting Decisions. A subset of these products, I might add, are an important aspect of peacetime operations, as they are essential components of safety of navigation and flight.



### **Slide 3 - Ocean-Atmosphere Models**

Nowcasts and forecasts are the results of high resolution, coupled ocean-atmosphere models that are used to predict future ocean states on a basin-wide scale.

### **Slide 4 - Model Output**

This slide shows the output of a recently-developed one-eighth degree latitude, multi-layered ocean circulation model of the North Pacific Ocean. This model relies on climatology, real-time data, and high speed, large scale computers to function. The outputs of such regional models are the basic parameters that go into military applications models that predict sensor and weapons performance at some specific time and location in that ocean basin.

### **Slide 5 - High Resolution Features**

This slide is a blow up of the previous one showing the fine detail that is resolved by the model.

### **Slide 6 - Real Time Data and Climatology**

High resolution ocean models are driven by data — both real time and climatological.

### **Slide 7 - Sources of Real Time Data**

Sources of real time observations are satellites, ships, aircraft, and drifting buoys — both of military and civilian origin .

### **Slide 8 - Source Statistics**

This slide shows a breakdown of the sources of the more than a quarter million observations received daily, on average, at the Fleet Numerical Oceanography Center in Monterey, California. Of these, half are for the ocean, the rest are for the land and the atmosphere. That number for the oceans is misleading, however, since it includes the approximately 120,000 Multi-Channel Sea Surface Temperature reports from meteorological satellites. With these removed, a woeful 1% of all observations received at FNOC are oceanographic.

**Slide 9 - Source Breakdown**

This slide provides a further breakdown of the worldwide source of the data received at FNOC on a typical day. Only the first three types of data are in situ oceanographic observations.

**Slide 10 - Climatology**

Given the paucity and uneven dispersion of the real-time data, we must fall back on climatology to provide the basic data to operate our models.

**Slide 11 - Navy Data Bases**

The U.S. Navy compiles and maintains an array of climatologies to support a wide variety of prediction models. Two of these involve ocean climate data. MOODS — the Master Oceanographic Observation Data Set — is a data base containing over 4.5 million profiles of quality-controlled observations of temperature, temperature and salinity, and sound velocity. GDEM — the Generalized Digital Environmental Model — takes the MOODS data base and, using a four-dimensional steady state digital model of ocean temperature and salinity, interpolates in time and space, and provides profiles of historical temperature and salinity over all ocean areas with bottom depth greater than 100 meters.

**Slide 12 - Surface Winds Climatology**

This slide is a typical output of one of the climatologies developed by the Naval Oceanography Command's Detachment at the National Climate Data Center in Asheville, North Carolina.

**Slide 13 - Large Scale Computers**

The assimilation of large and diverse data sets requires very powerful computing capabilities. For this the Navy has acquired two Class VII supercomputers — a CRAY Y-MP-8 at the Naval Oceanographic Office in Mississippi, and a CRAY Y-MPC90 at Fleet Numerical Oceanography Center in Monterey.

**Slide 14 - Primary Oceanographic Prediction System**

The first Large Scale Computer is installed and is up and running at the Naval Oceanographic Office, Stennis Space Center, Mississippi. The second is on order and is expected to become operational at the Fleet Numerical Oceanography Center in Monterey, California later this year or the beginning of next. In addition

to ingesting and manipulating large amounts of data, the supercomputers, their peripheral hardware and software — which collectively we call the Primary Oceanographic Prediction System — will run the operational forecasts for day to day fleet support. As the slide indicates, there is sufficient reserve for research and development, and for the evaluation of developmental models. We have configured the system so that we can accommodate federal and academic researchers who have need for access to a supercomputer, at very economical rates. This should be of particular value to the climate change research community.

### **Slide 15 - Naval Applications of Climatology**

This slide conceptualizes the role of climate data in operational Naval Oceanography as it is currently applied. Essentially, the real-time observations, which are mostly from satellites, and therefore two-dimensional, are combined with model output data from previous runs to update climatologies, allowing extension of the data fields to the third dimension, the vertical. This newly derived data set is used to initialize the operational models that provide the fourth dimension, time, allowing the production of oceanographic predictions. These are the up-to-date operational products that naval components around the world can access to activate the sensor and weapon performance predictions and tactical decision aids that were, if you recall, in the top box of the earlier slide describing the "Process." These are the deliverables in military parlance.

### **Slide 16 - Navy a Consumer and Producer of Ocean Data**

It is important to remember that when it comes to both real time data and climatologies, the U.S. Navy is both a consumer and a producer. We employ the climatological data that is available in the national archives, such as the National Oceanographic Data Center. We also make real-time use of the earth observing sensors aboard the NOAA polar orbiting meteorological satellites. In turn, data collected from our Navy ships, such as Expendable Bathythermograph data, are made available to NODC for archiving. And, sensor data from the Department of Defense's Defense Meteorological Satellite Program are also made available to the appropriate national archive facilities for further use and dissemination. These are only a few of many examples of such cooperation and mutual benefit.

The Oceanographer of the Navy is actively supporting the production of marine atmospheric climatologies through the day-to-day efforts of the Commander, Naval Oceanography Command's Detachment at the National Climatic Data Center, Asheville, North Carolina.

Finally near-real-time access to Navy oceanographic and meteorological products is available to the civilian community through the NOAA facilities colocated with the Fleet Numerical Oceanography Center in Monterey.

## Slide 17 - Improvements

Since the stated Workshop objectives are to identify ways to improve: "data management," "access to marine data," "management systems to support ocean monitoring and predictions," and "data services," I would like to share some thoughts with you on the subject of improvements.

Under the topic of observations:

- We should selectively increase the coverage of ocean observations through a judicious choice of space-based and in situ observations; by carefully employing the most cost-effective technology, and by taking advantage of what we have already learned about the oceans to determine where, how often and at what spatial resolution we need to make these observations to adequately describe the environment so as to make predictions at an acceptable level of accuracy. It would seem that what we are discussing here is relevant to the emerging national and international efforts to coordinate the development of a Global Ocean Observing System. We recognize that many of the U.S. Navy's ocean observing systems could factor into the architecture and implementation of a Global Ocean Observing System.
- We should reduce the uncertainty of measurements by enlisting the best scientific talents of the research community to ensure the quality and appropriateness of measurement techniques; and we should encourage industry to produce reliable, low-cost instrumentation that will meet the twin technical objectives of increased accuracy and coverage.
- We need to extend observations to the shallow water areas of the world to include the coastal regions and semi-enclosed seas. This may require new measurement techniques and instrumentation than that which has been designed for the open ocean, as well as new organizational and cooperative arrangements.

With regard to models:

- We need to improve our predictive models to increase their resolution and extend their predictive range.
- Models need to be developed that couple the ocean with the atmosphere, and with ice cover and the atmosphere in polar regions.
- Models need to be able to assimilate and merge diverse data sets that measure the same parameters. For instance, we need to be able to combine satellite altimetry and sea surface temperature measurements to locate ocean fronts and eddies and to estimate current velocities.
- Finally, we need to extend our high resolution air/ocean models to as-yet-unmodeled regions of the world's oceans and to create reliable models that are applicable to coastal areas and semi-enclosed seas.

As for climatology:

- We need to fill in the spatial and temporal gaps in the record with new observations where necessary, and with as-yet-unarchived data wherever they may be found.

- We need to be able to quantify variability of data at grid points in the climatologies, so as to be able to put meaningful bounds on the limits of predictability in the forecasts.
- Also, we need new climatologies that are the product of different measurement techniques that measure the same parameter — we call this Data Fusion — where such new products improve the accuracy or resolution of the measured parameter.

### **Slide 18 - Conclusion**

In conclusion, ocean climate data are important to our way of doing business in operational Naval Oceanography. The U.S. Navy is interested in the future of climatologies by participating in their improvement through continued contribution of observations and constant research on methods for making most effective use of climatologies in our prediction models.

We encourage the participants to pursue the stated objectives of the Workshop to the benefits of all users of ocean climate data, and share with you a mutual interest in the development of ocean climatologies for all of the multitude of purposes they serve.

# Fleet Support

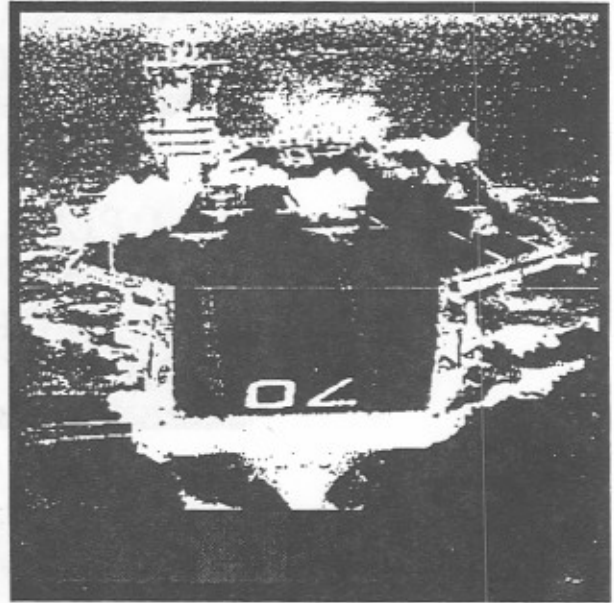
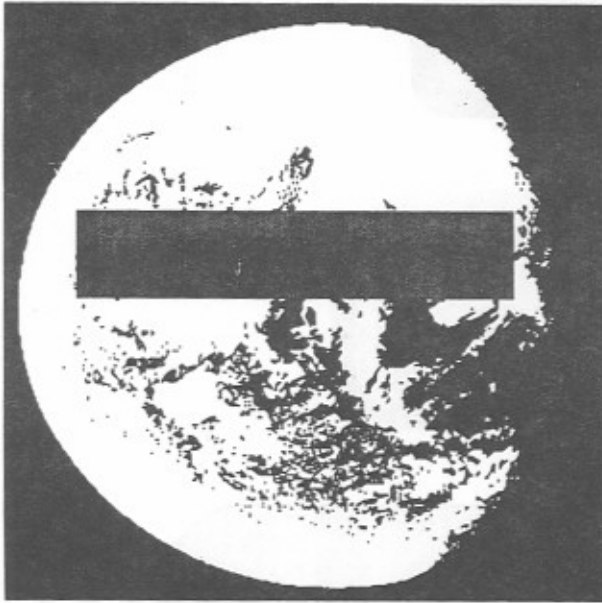

*Slide 1*

# The Process . . .

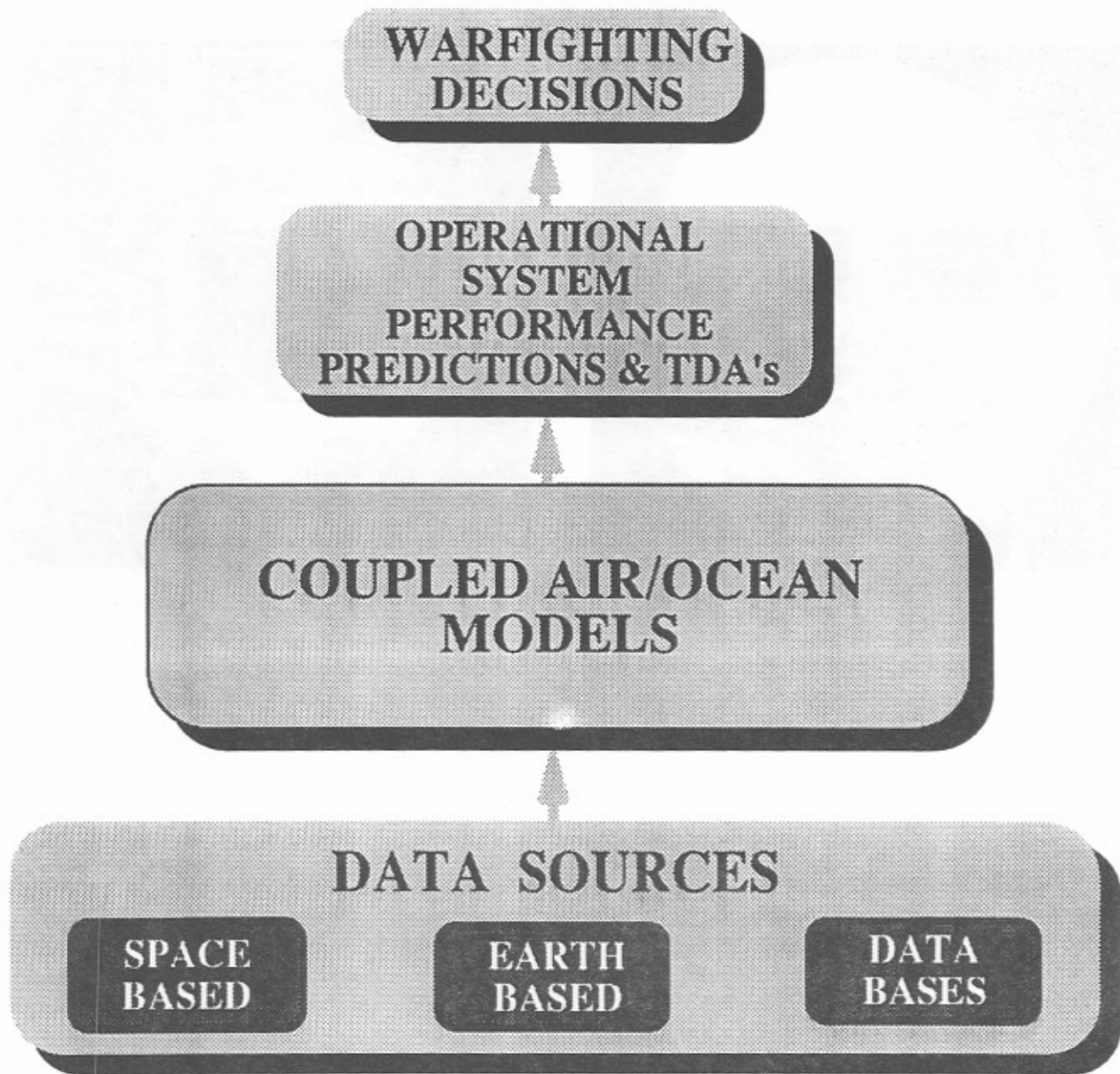

Slide 2

# Nowcasts / Forecasts ...

## From High Resolution Global Models

Slide 3

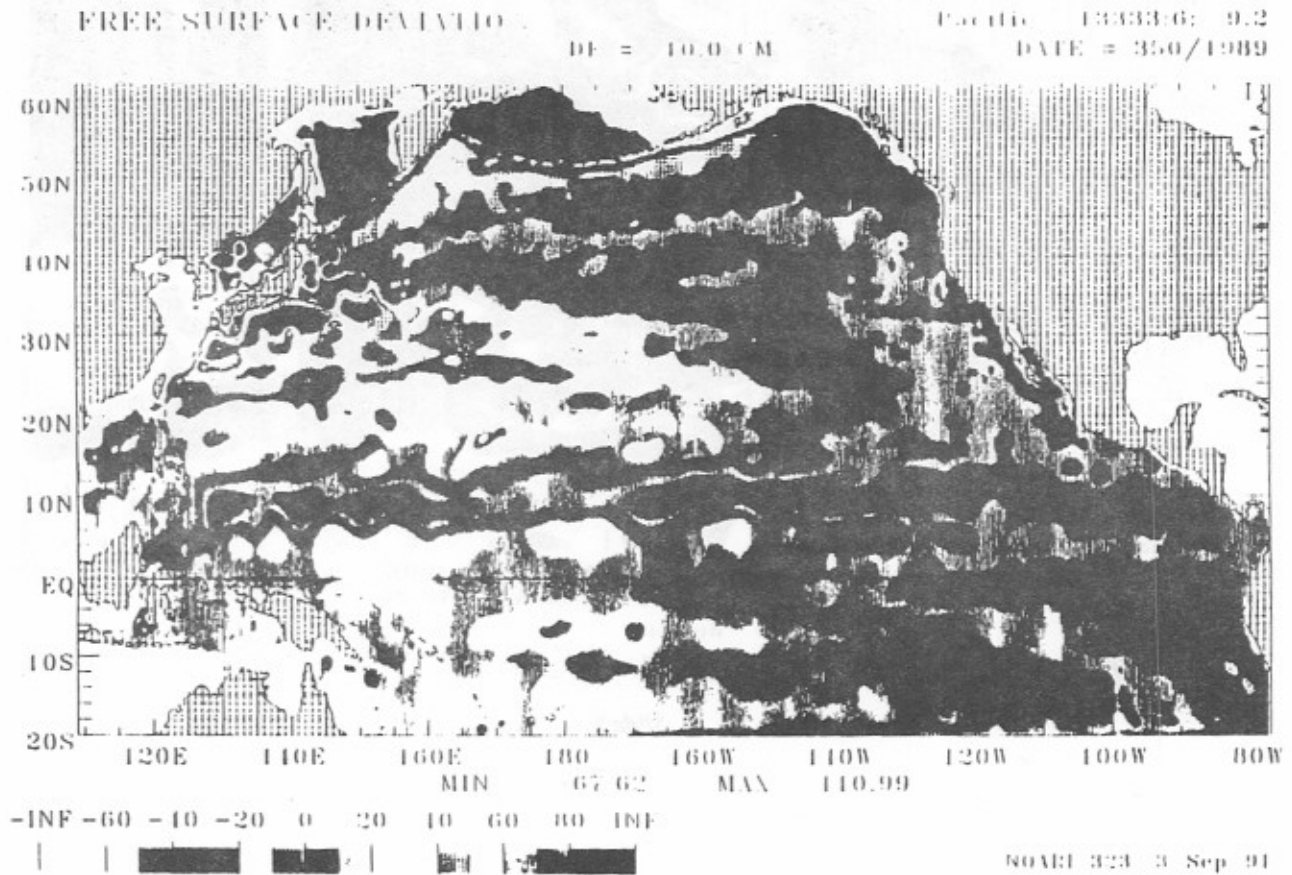

Slide 4



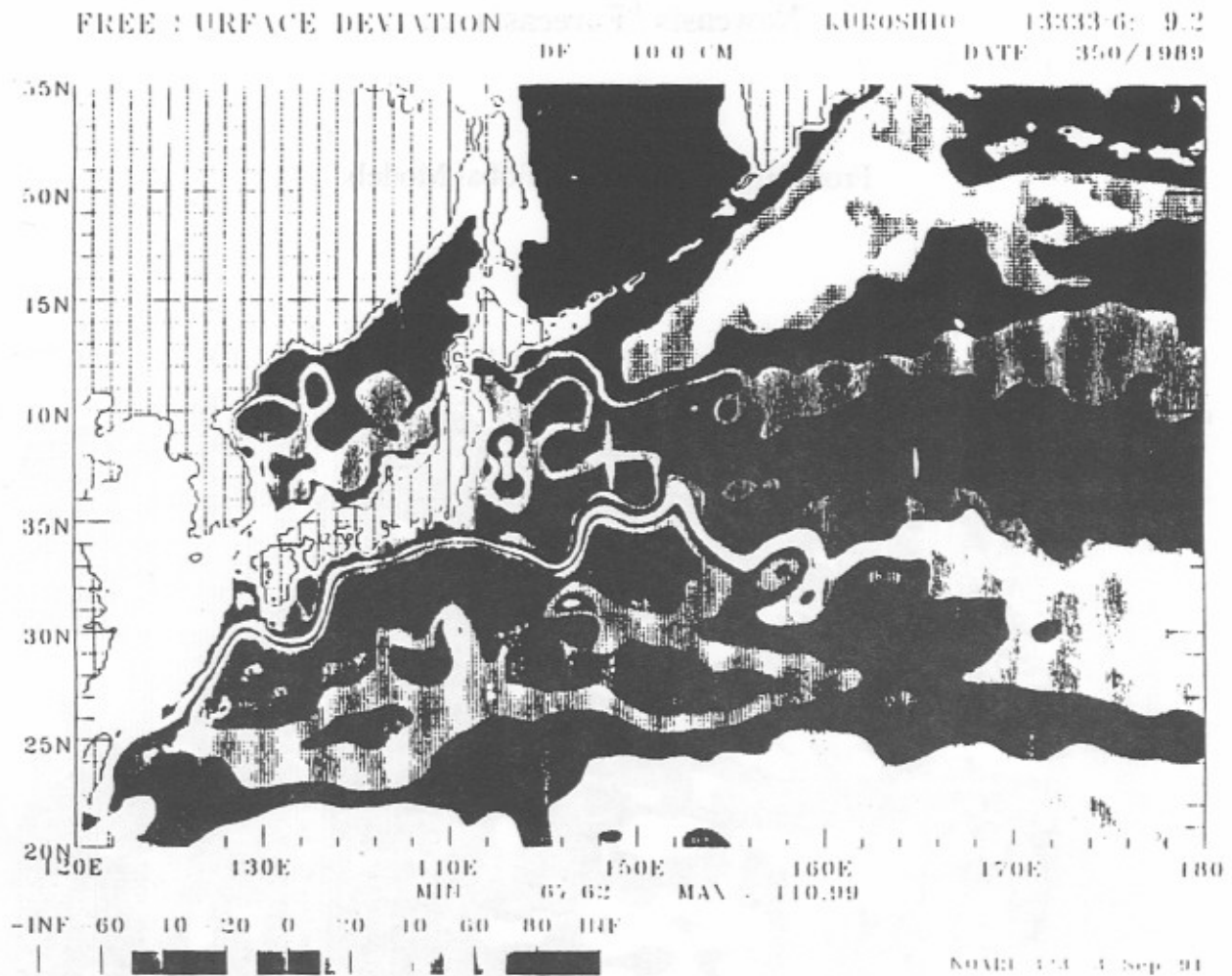

Slide 5

## High Resolution, Coupled Ocean-Atmosphere Models . . .

Driven By:

- Real-Time Data Bases
- Climatological Data Bases

*Slide 6*

## Sources Of Observations

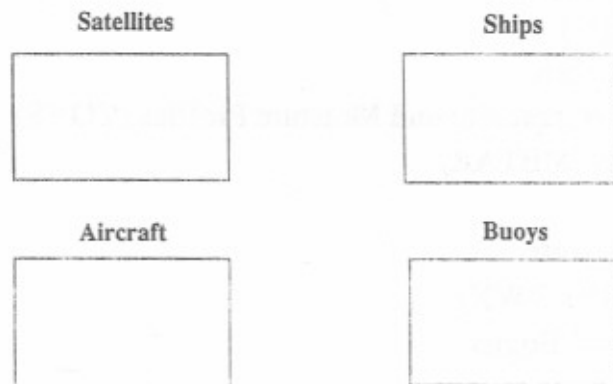

*Slide 7*

## Where The Observations Come From

- 236,100 Obs Received Each Day by FNOC
  - 20% Land
  - 28% Atmosphere
  - 52% Ocean (Note: Only 1% if Satellite SST Removed)
- Source of Obs
  - 65% Satellite
  - 33% Other (Land, Balloon, Rawinsond, Ect.)
  - 1.5% ship
  - 0.5% Buoy

*Slide 8*

## Environmental Data Received And Processed At FNOC Every 24 Hours

<u>Type of Data</u>	<u>Number of Obs</u>
Surface Ship Reports	3,000
Drifting Buoy Reports	200
Bathythermograph Reports	250
Ocean Front and Eddy Positions Inferred from Satellite Imagery	1,000
Pilot Balloon (PIBAL) Reports	1,450
Aircraft Reports (AIREPS)	4,000
Radiosonde (RAOB) Reports	1,600
Satellite Atmospheric Temperature and Moisture Profiles (TOVS)	22,300
Airport Weather Reports (METAR)	24,000
Surface Land Reports	36,000
Hourly Surface Land Reports	12,000
Cloud Track Winds (TSX< TWX)	10,200
Australian Meteorological Bogus	+ 100
<b>Total</b>	<b>116,100</b>
Multi-Channel Sea Surface Temperature (MCSST) reports	+ 120,000
<b>Total</b>	<b>236,100</b>

Slide 9

### High Resolution, Coupled Ocean-Atmosphere Models . . .

Driven By:

- Real-Time Data Bases

- Climatological Data Bases

Slide 10

### Navy Climatological Data Bases

- MOODS (Master Oceanography Observation Data Set)
  - 4.5 Million Quality-Controlled Profiles of Temperature, Salinity, and Sound Velocity
- GDEM (Generalized Digital Environmental Model)
  - 4-D Digital Model of Ocean Temperature and Salinity Spatially and Temporally Interpolated

Slide 11

### Navy Climatology Sample

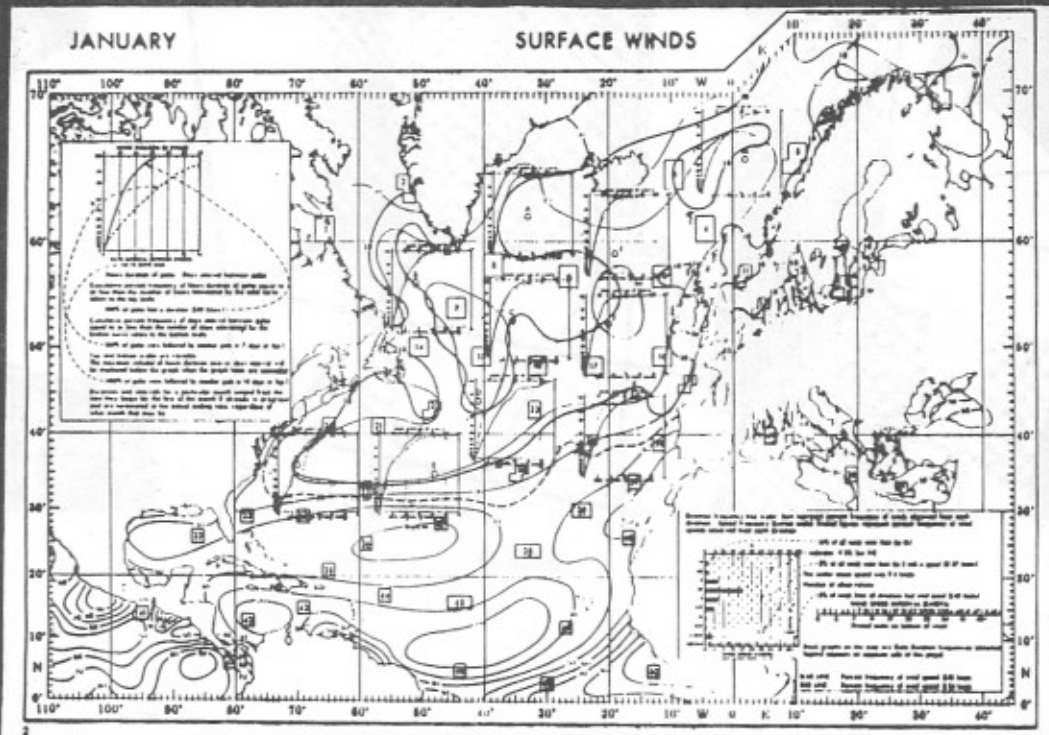

Slide 12

# Assimilation

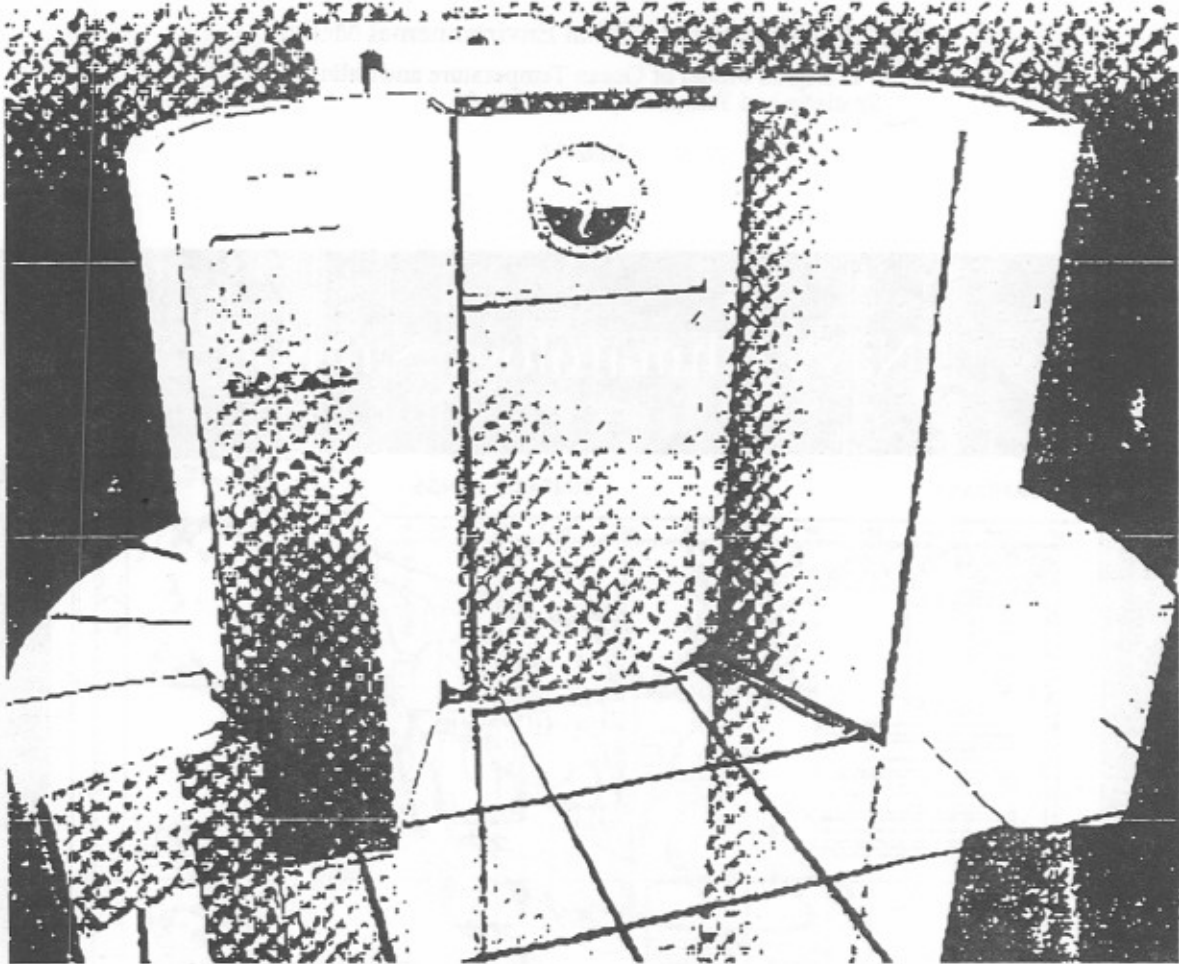

*Slide 13*

## **Primary Oceanographic Prediction System**

**POPS-1  
Cray Y-MP8/8128**

- **Naval Oceanographic Office (NAVOCEANO)  
Stennis Space Center, Ms**
- **Oceanography Related R&D Support  
Other CNR Vector Supercomputer Support  
CNOC Related Operational Production Support**
- **Planned Emphasis - 50% R&D 50% OPS  
Initially Greater Emphasis On R&D  
Service Bureau Support Oriented**

**POPS-2  
Cray Y-MP C10/10,000**

- **Fleet Numerical Oceanography Center (FNOC)  
Monterey, CA**
- **Operational Production Support  
Planned Emphasis - 100% OPS**



# **COMNAVOCEANCOM**

Slide 14

## Concept of Operations

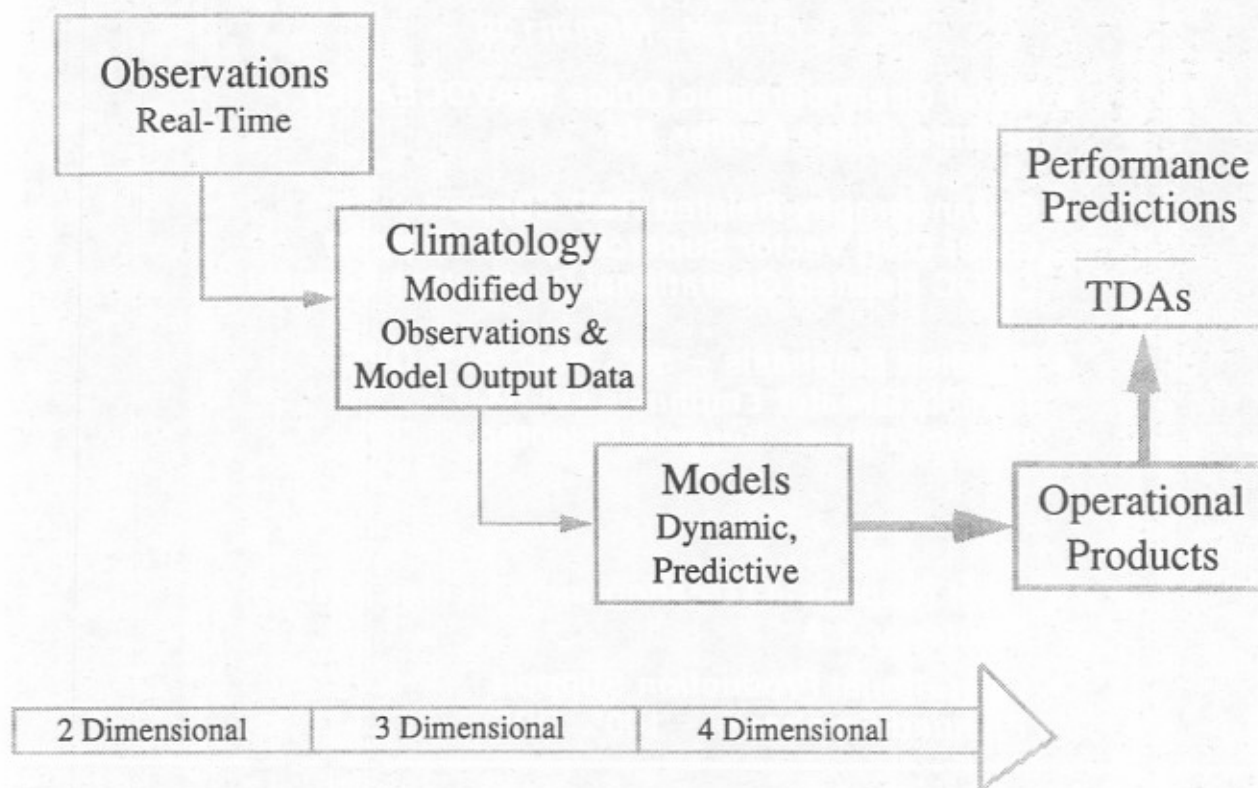

Slide 14

### Navy A Consumer And Producer Of Ocean Climate Data

- Consumer
  - Output of National Archives used in Compiling Data Bases
- Producer
  - Navy Ocean Climate Data Provided to National Archives
  - Navy Detachment at NCDC Asheville Produces Marine Climatologies
  - Near-Real-Time Access to FNOC Products Through Co-Located NOAA Facility at Monterey

Slide 16

## Areas For Improvement

- Observations
  - Selectively Increase Coverage, Timeliness (GOOS)
  - Reduce Measurement Uncertainty
  - New Frontiers (Coastal and Semi-Enclosed Seas)
- Models
  - Increase Resolution; Extend Temporal Range
  - Couple Air/Ocean and Air/Ice/Ocean
  - Assimilate Diverse Data Sets
  - Develop for Unmodelled Regions
- Climatology
  - Fill in Gaps (Spatial & Temporal)
  - Quantify Variability
  - New Products (Data Fusion)

*Slide 17*

## Summary

- Ocean Climate Data Essential to Operational Naval Oceanography
- Improvements to Ocean Data Climatologies a Matter of Mutual Interest and Cooperation

*Slide 18*



## **International Organisation of Ocean Programs— Making a Virtue of Necessity**

---

**Angus McEwan**

When faced with the needs of climate prediction, a sharp contrast is revealed between existing networks for the observation of the atmosphere and for the ocean. Even the largest and longest-serving ocean data networks were created for their value to a specific user (usually with a defence, fishing or other maritime purpose) and the major compilations of historical data have needed extensive scientific input to reconcile the differences and deficiencies of the various sources. Vast amounts of such data remain inaccessible or unusable. Observations for research purposes have been generally short lived and funded on the basis of single initiatives. Even major programs such as FGGE, TOGA and WOCE have been driven by the dedicated interest of a surprisingly small number of individuals, and have been funded from a wide variety of temporary allocations. Recognising the global scale of ocean observations needed for climate research, international cooperation and coordination is an unavoidable necessity, resulting in the creation of such bodies as the Committee for Climatic Changes and the Ocean (CCCO), with the tasks of:

- (i) Defining the scientific elements of research and ocean observation which meet the needs of climate prediction and amelioration.
- (ii) Translating these elements into terms of programs, projects or requirements that can be understood and participated in by individual nations and marine agencies.
- (iii) The sponsorship of specialist groups to facilitate the definition of research programs, the implementation of cooperative international activity and the dissemination of results.

It cannot be presumed that the governments of various nations have a preexisting interest in climate prediction, and there certainly exist wide differences between countries in the organisation and sponsorship of marine science and marine monitoring. Many countries need guidance on the best way in which they can participate and gain benefit from international programs and there is a widely expressed need for training and rudimentary assistance in getting national marine programs underway, which at times is difficult to reconcile with the interests of the more experienced international participants.

Possibly the greatest challenge in the implementation of the systems for global and long-term acquisition of ocean climate data will be to place on a firmer and more permanent financial footing the national contributions to a global network, to a level comparable (in organisational if not financial terms) with the World Weather Watch. This problem has many facets, some of them being:

1. Since the need for the network is perceived to be 'scientific' and not in the service of defence commercial advantage or operational necessity it is very difficult for ocean monitoring activities to be regarded as an ongoing, national 'operational' need in the same sense as meteorology. They are and will remain within the management and budget portfolios of national research activity. Furthermore in some countries this activity is partitioned in several departments such as commerce or education, whose central interests are directed to more urgent perceived priorities. Also, budgets are granted through a scientific review process so that monitoring activities have to be couched in terms of scientific project objectives.
2. Although in the short-term the highest priority need in ocean data is physical data for the validation of climate models, there exists a parallel need for chemical data for the description of trace constituent budgets, deep ocean circulation parameterisation and for the development of models for biological feedback and climatic impact on ocean productivity. There may also be a strong socially-driven demand for base-line and time series information on near shore physical, chemical and biological indicators. Therefore the meteorological observational networks which are very comprehensively organised through WWW are not necessarily ideal for oceanographic data requirements since they lack the linkage to non-physical disciplines.
3. The experience of TOGA and WOCE has demonstrated that large scale international activities can be very successfully promoted if couched in terms of a coherent scientific program. The creation of scientific and implementation plans and the convening of scientific meetings provides an effective focus for the definition of national activities, the promotion and sponsorship of these activities by governments and granting bodies and a platform for the recognition of individual scientists.

At this stage it is not clear if an observing system program such as the Global Ocean Observing System has an appeal which will accrue the same benefits. In the absence of an ongoing national framework for sponsorship of new ocean monitoring activities, it will be difficult for scientists at national level to press for involvement, yet the interest of active scientists and their participation at international fora is central to the success and quality of the system. Indeed to a large extent the advocacy of a GOOS is, at national level, in the hands of people who have very little to do with in the practical implementation of the system and its subsequent operation, namely the climate modellers and climate analysts.

4. Apart from scientists there will be substantial manpower and technical resource implications in the creation of GOOS. Such a system requires trained manpower that is presently in short supply, and a high degree of technical backup, not to mention ships and automated acquisition and data transmission systems. The scale of enlargement over existing experimental networks such as the TOGA Subsurface network is enormous and it cannot be assumed that the task is simply a process of 'scaling up'.
5. In practice the likely scenario is that existing oceanographic agencies will gradually acquire the 'secure' resources to implement long-term observing activities, but the responsibility for these activities will strain existing infra-

structure. In some countries resources might be 'liberated' by military wind-down if political strings can be pulled.

6. It will be essential that data management systems established to cope with ocean monitoring be standardised in access and procedure, efficient, economical and above all accessible to national users at a wide range of levels of sophistication. For the principal suppliers of such systems such as the USA it must be assumed a priori that a 'user-pays' framework is not the way to go.

CCCO has now been in existence for 13 years as a joint committee of ICSU/SCOR (representing the scientific interest in the Oceans) and IOC (the UNESCO intergovernmental framework within which international marine activity is conducted). It is composed of 14 senior members of the oceanographic community and its subsidiary bodies involve renowned climate scientists. In that time it has participated in a remarkable transition in international oceanography that has witnessed the creation of the TOGA program, now two-thirds through its implementation, and the commencement of WOCE. Ironically although CCCO was the prime mover in the creation of these, the most active elements of the WCRP through the '80s, steps have recently been taken to place these programs under the sole control of the JSC of the WCRP, with the participation of an 'executive group' of CCCO delegates. In my opinion one of the important elements in the success of CCCO has been its ocean panels which have provided a very effective form for active scientists in the three ocean basins to facilitate the implementation of the TOGA and WOCE programs. The CCCO has also sponsored or jointly sponsored with JSC/WCRP many other working groups and activities including the Ocean Observing System Development Panel (OOSDP).

The terms of reference of the OOSDP are:

- (i) To formulate the conceptual design of a long-term systematic observing system monitor, describe, and understand the physical and biogeochemical properties that determine ocean circulation and the seasonal to decadal climate changes in the ocean, and to provide the observations needed for climate predictions.
- (ii) To cooperate as appropriate with the planners of other scientific or operational programmes related to climate and climatic change and to collate relevant data requirements and observing system specifications.
- (iii) To liaise with responsible scientific institutions and agencies, including environmental administrations and space agencies, to attempt to ensure the compatibility of the proposed global ocean observing system development programme with the long-term plans of these organizations.

These terms of reference reflect some of the concerns mentioned earlier, recognising of the need for active scientific involvement and accommodation of the existing and varied means by which national networks might be developed for the creation of a Global Ocean Observing System.

Unlike the atmosphere, the ocean is subject to territorial control, so the International Oceanographic Commission is inextricably involved in the implementation of such a worldwide system. Within the existing structures and subsidiary bodies of IOC, the CCCO carries the mandated responsibility for the scientific development of the system, and this is one of its main tasks now that TOGA and WOCE are underway. It is also examining possibilities for future oceanographic program related to oceanic variability not likely to be accommodated within the WCRP, and carries primary responsibility for IOC advice on various international initiatives relating to the oceanic interests in global climate change, impacts and response, including IPCC.

Like all such bodies, CCCO is dependent on vectored national sponsorship and the willing participation of its eminent membership. Unlike most it aims to span the space between what has traditionally been a scientific discipline for individual scientists and a vast and complex inter-governmental network. Unlike meteorology, international oceanography cannot rely on traditionally strong international disciplinary networks and statutory organisations. All this has to be created in response to the weight of global public demand, a demand which has yet to develop a coherent voice.

A Global Ocean Observing System will not be created out of the will of individual academic scientists. It will not emerge spontaneously from concerted intergovernmental pressure. While its needs might be articulated by climate scientists who have the ear of national government, it will not be they who bring about its implementation. Indeed the scale of the task demands some moderation of the imagination of such scientists. Creation of GOOS will depend upon constructive application of new facilities and techniques applied to prosaic tasks such as data management. It will depend on new sources of funds that separate oceanographic research and monitoring functions worldwide and it will depend on an ongoing critical scientific evaluation of the design of the system itself. It will also depend on a conviction of the value of GOOS by the major agencies on which the task of implementation must inevitably fall. For all of this there is needed a medium for scientific planning, for facilitating interaction, cooperative arrangements and information flow, for endorsement and assistance through the major international and intergovernmental bodies of ICSU, IOC and WMO. This CCCO has the mandate to provide.

## **Postscript**

In early March, shortly after the presentation of this paper, the Executive Council of IOC elected to replace CCCO with a Scientific and Technical Advisory Committee for GOOS, and also created an (intergovernmental) IOC Committee for GOOS. The module of GOOS concerned with 'climate monitoring assessment and prediction' has much in common with the 'Ocean Observing' element of the Global Climate Observing System (GCOS) being jointly developed by WMO, IOC, ICSU and UNEP. These two components represent an important bridge between GOOS

and GCOS and it was agreed shortly afterwards that they both be developed as a single unit by OOSDP. It appears therefore that the structures are largely in place for at least the international and intergovernmental development of Ocean Observations in relation to the monitoring and prediction of climate. This will facilitate links at national level between meteorological agencies and oceanographic agencies for the coordination of effort towards integrated ocean observation. Nevertheless the importance of involving and arousing the interest of practising oceanographic researchers should not be overlooked, and most of the cautionary remarks in the foregoing paper remain valid.

## **Role of the Ocean in Climate Changes**

---

***Sergey K. Gulev***

### **Introduction**

The present program aimed at the study of ocean climate change is prepared by a group of scientists from State Oceanographic Institute, Academy of Science of Russia, Academy of Science of Ukraine and Moscow State University. It appears to be a natural evolution of ideas and achievements that have been developed under national and international ocean research projects such as SECTIONS, WOCE, TOGA, JGOFS and others.

During last two decades main efforts were concentrated on quantitative experimental and model description of the ocean's role in the global climate change. In particular, the significance of the energy active zones of the ocean in the ocean-atmosphere interaction processes was defined; the connections between the sea surface temperature (SST) anomalies and the inter annual variations of the global atmosphere circulation were established; the stability of the meridional ocean thermohaline circulation and its influence on global climate was carefully concerned about. The derived results have proved the exclusively important role of the North Atlantic as a key feature in formation of the global "conveyor" of interoceanic circulation, which determines the long-period variability of the entire climate system.

All above mentioned plus the possibility of conducting relatively inexpensive field experiments allows to address the North Atlantic as the most suitable site for studies of the Role of the Ocean in Climate Change (ROCC).

The two primary goals are set in the program ROCC.

1. Quantitative description of the Global interoceanic "conveyor" and its role in formation of the large scale anomalies in the North Atlantic.

The objectives on the way to this goal are:

- to get the reliable estimates of year-to-year variations of heat and water exchange between the Atlantic ocean and the atmosphere
- to establish and understand the physics of long period variations in meridional heat and fresh water transport (MHT and MFWT) in the Atlantic ocean
- to analyze the general mechanisms, that form the MHT and MFWT in low latitudes ( Ekman flux ), middle latitudes ( western boundary currents ) and high latitudes ( deep convection) of the North Atlantic.
- to establish and to give quantitative description of the realization of global changes in SST, surface salinity, sea level and sea ice data.

2. Development of the observational system pointed at tracing the climate changes in the North Atlantic.

This goal merges the following objectives:

- to find the proper sites that form the inter annual variations of MHT
- to study the deep circulation in the "key" points
- to develop the circulation models reflecting the principle features of interoceanic circulation
- to define global and local response of the atmosphere circulation to large scale processes in the Atlantic ocean.

### **Ocean and the Climate**

The forecasting of the climate changes is probably one of the most important problems of our time. In spite of the sufficient knowledge about the processes going on in main components of the climate system, complete and adequate description of the mechanisms governing the state of the system and its variations seems to be hardly possible. This is mostly due to the high complexity of the climate system - great number of components and complex system of feedback.

The variations of the climate system is obviously determined by different factors on different time and space scales. The ocean with its tremendous heat capacity is a sort of a heat accumulator and redistributes, its inter-relation with other components has to be significant on long time periods, comparable to time scale of ocean characteristics variability, and space scales comparable to scales of individual ocean basins.

It is not yet definitely clear whether the ocean appears to be a passive substance in the between components interaction, or it can induce changes in other components of the climate system (first of all in the atmosphere). The first point of view was evolved by Hasselmann (1974), who used the concept of stochastic climate models, and considered the ocean as inertial climatic subsystem, which was subjected to permanent random atmospheric forcing. It was shown that a complete passive ocean could turn the random high frequency input of the atmosphere into much lower frequencies in SST. The other approach was introduced by Bjerknes (1962), who found and suggested an explanation to close relation between the tendencies in SST behavior and time evolution of North Atlantic atmospheric circulation index, reflecting the surface pressure difference between the Azores High and Icelandic Low. The following studies (Palmer, Sun, 1985; Wallace, Jiang, 1988; Lau, Nath, 1990) proved the existence of the atmospheric response to SST anomalies.

Without neglecting the Hasselmann theory, it seems that there are strong evidence of the ocean active role in the long-term variations of the climate system.

## Global Ocean "Conveyor"

The physics of interaction states that the only possible way of ocean forcing to atmosphere is by the fluxes of heat and water, that are primarily (from ocean point of view) defined by the SST. Thus in order to study the ocean climatic signal, it is important to define the processes that can form and support the long lasting anomalies of SST. In the paper by Folland et al.(1986) devoted to computation of empirical orthogonal functions (EOF) of global SST record (1901-1980), one of the EOF reflected the space pattern of SST with maximum values in high latitudes in both hemispheres (with different signs) and amplitude variability over a period of approximately 40-50 years. The variability of such a period can be formed only by significant changes in global ocean circulation (GOC).

Schematically GOC can be introduced at the movement of two layer liquid. It is known that due the difference in thermohaline properties the North Atlantic has greater mean density than the North Pacific. The relative level of these two basins differs almost by one meter and the age of the deep waters (estimates based on the radiocarbon data, neglecting the exchange with the upper layers) differs by more than 1500 years. Thus the upper warm water following the level inclination flows from the North Pacific to the North Atlantic, and the underlying cold water flowing in the opposite direction (Broecker, 1974; Lappo, 1984; Gordon, 1985). The overturning of the water occurs in the North Atlantic as a result of the heat loss of the upper water to the cold air which leads cooling of the water and it's consequent sinking (the effect known as the deep convection) (Fig. 1). The malfunctioning of this water "conveyor", can occur at the period of invasion of the Arctic ocean waters, that have positive buoyancy even at low temperatures, to the North Atlantic. This induces the restructure of ocean circulation. In theoretical studies of Stommel (1961), Rooth (1982) and model experiments of F. Bryan (1986), Manabe, Stouffer (1987) it was shown that both these ocean states can be stable.

On the background of global interoceanic exchange a smaller scale circulation cells also playing an active part in exciting the inter annual variations in the atmospheric characteristics can also be pointed out. The careful study of such mechanism in the North Atlantic was performed by Bjerknes (1964). Bjerknes suggested two regimes of heat in transport in the North Atlantic. The strong zonal circulation of the atmosphere the Northern hemisphere (high values of the zonal circulation index) increases the expenditure of the North Atlantic current, so the ocean carries more heat towards the north (the regions of North Atlantic deep Water formation). The weak zonal circulation decreases the heat transport of the North Atlantic current, at the same time increasing the temperature contrast between the waters of middle and high latitudes of the North Atlantic and meridional heat transport in the atmosphere.



## Extraordinary Features of the North Atlantic

Taking in account the state of development of the ocean observational systems it seems impossible to set a task of studying all the elements of the global interoceanic "conveyor". It is more reasonable to concentrate the attention on the ocean basins where the traces of the "conveyor" are most apparent. The suitable site for these purposes is the Atlantic ocean and especially it's northern part.

Atlantic is the only ocean with two polar sources of deep waters. The North Atlantic is the source for North Atlantic deep water (NADW), but up to 50 -55 N one can spot the signs of Antarctic Bottom Water (ABW) as well.

The role of the Atlantic in the changes of upper water characteristics is demonstrated on Figure 2. where the comparison of Lazier (1980) data from the ocean weather station "B" in the North Atlantic and Kort (1974) data from hydrological section in the North Pacific is shown.

The North Atlantic is characterized by extremely high heat fluxes to the atmosphere. The integral turbulent fluxes from the North Atlantic surface are equal to  $7.1 \cdot 10^6$  W. Thus occupying only 11% of the total World Ocean surface. North Atlantic is responsible for 21% of sensible, 16% of latent and 17% of total heat fluxes. This allows to consider the North Atlantic as the energy active zone of the World Ocean (Gulev, Lappo, 1988)

Very important integral parameters reflecting the large-scale interaction are the MHT and MFWT. MHT in the Atlantic has two remarkable features. First of all. It is the northward heat flux in the South Atlantic and trans equatorial heat transport of the same direction that equals to approximately 10 W. This result was derived by Hastenrath (1977, 1980) and then confirmed by direct and balance estimates (Bunker, Lamb, 1982; Roemmich, 1984; Wunsch, 1985; Gulev, Lappo, 1986, 1988; Isemer, Hasse, 1990, etc). Secondly, it is non unique regime of MHT in the middle latitudes of the North Atlantic (Gulev, Lappo, Tichonov, 1988). one corresponds to the transit of heat through the middle latitudes, the other to intensive heat loss in the Gulfstream delta area. The latter is demonstrated on Figure 3. where the non dimensional curves of MHT, corresponding to above mentioned regimes are shown. More carefully this phenomena is going to be described further on.

The North Atlantic is very sensitive to variations of MFWT, as well, because it is the place of formation of great amount of deep waters of the ocean. so even little changes in salinity can completely change the conditions of the convection.

Resuming, it is necessary to state that the observational part of the program must be concentrated in the North Atlantic, also all the archives data and incoming data from the ongoing research studies in other ocean basins must be used for purposes of understanding the ocean climate.

## **Different Aspects of Oceanic Component of Global Climate**

In order to solve the problems set by the program ROCC. It is necessary to focus on the characteristics of the ocean that are most important in climate sense. The experimental works in the ocean conducted for this purpose will provide field data for testing and creation of reliable parameterizations in mathematical models and reveal the simple physical relations in the climate system that will serve as the base for climate forecasting. It seems that the major attention must be paid to the meridional transport and the level of the ocean as the highly informative integral parameters and also to SST and surface salinity anomalies and to variations in heat and water exchange as the direct agents in influencing the atmosphere.

### **Characteristics of the Ocean-Atmosphere Energy Exchange**

Calculation and analyses of heat and radiation fluxes on the ocean-atmosphere boundary in the North Atlantic revealed the extremely uneven pattern of heat exchange and evaluated the dominating share of turbulent sensible and latent heat fluxes variability in total dispersion of heat balance. The latter proved to be 10 times greater than the contribution of radiation balance variations (Gulev, Lappo, Tichnov, 1988). It should be noted that the mean annual distribution of this characteristics are more or less the same in papers of different authors (in sense of extremums location) but the values differ in the range of 20-150% for individual points and less than 50% for zonal means. The most significant differences occur in the middle latitudes for sensible and latent heat and in tropics for radiational fluxes. The knowledge of interannual variations of the exchange processes seems to be inadequate. The attempts to approach this problem are confined by the studies of Bunker (1988) and Gulev, Lappo, Tichonov (1988), who never the less found reliable trends (up to 6-10 W/m) in local areas.

The most important objectives in the study of the interannual variability should be :

- Creation of the basic data set of marine meteorological information. It can be possible under international community efforts to update COADS data which is now criticized for several reasons (interpolation algorithms, wind speed data, etc).
- development of new generation of parameterizations of exchange processes, oriented on large scale interaction and considering the effects of time and space averaging.
- Estimation of interannual variability using the new technologies in long time series analyses with parameterization of phase-amplitude characteristics of seasonal cycle.

### **Meridional Heat and Fresh Water Transport**

The MHT system in the North Atlantic is zonally divided according to the mechanisms that provide the northward transport of heat. That is why in order to study the whole system, each individual mechanisms must be carefully investi-

gated and the complex of direct and feedback relations between these mechanisms must be determined.

In tropical latitudes of the North Atlantic the main mechanism of interannual and seasonal variations of MHT is the Ekman transport (Bulgakov, Polonsky, 1988, 1990; Efimov, 1989; Levitus, 1987). Interannual variations of Ekman transport have the amplitude of  $3-5 \cdot 10^6$  W and seasonal variations  $5-7 \cdot 10^6$  W. At the same time annual mean MHT on the 20 N varies from 1.5 to  $2.5 \cdot 10^6$  W (Gulev, Lappo, Tichonov, 1988). For the first time the low frequency interannual variations of the SST in the tropical Atlantic ocean were detected by Merle et al. (1979). Later Folland (1986) established the relation between the large-scale heat anomalies in the tropical Atlantic and the Sahel drought.

The relations between the atmosphere dynamics and the heat transport in the tropical Atlantic are also seen in variations of El-Niño South oscillation system (ENSO). When ENSO occurs, the trade winds over Atlantic weaken and that leads to formation of heat anomaly in the ocean which in its place influences the Hadley circulation. Intensification of the latter increases the trade winds and ocean comes back to its original condition. Such feedback in the ocean-atmosphere system is more or less reliably determined for anomalous conditions and still needs further detailed quantitative study.

The middle latitudes of the North Atlantic are characterized by the extreme values of heat fluxes on the ocean-atmosphere boundary and by extreme variability of these fluxes. That is why the problem of heat balance in this part of the ocean is very important. As it was shown by Rago, Rossby, (1987) by the analyses of hydrological data, on the zonal section 32 N, the integral MHT is primarily governed by the baroclinic movements, mainly concentrated in the Gulfstream area. Thus the dynamics of the western boundary current plays an exclusive role from the point of view of the MHT variations. This fact is emphasized by the results of Volkova, Gulev, Lappo, (1987) who found that the regions of the maximum ocean-atmosphere interaction coincide with the western boundary currents.

Gulev, Lappo, Tichonov (1988) derived two regimes of MHT characterized by different role of the middle latitudes (Fig. 3). The nondimensional profiles of the MHT (for 18 years period) are clearly separated into two types. The first, corresponds to the active heat loss in the tropical and subtropical zone of the North Atlantic and the heat transit in the middle latitudes. The second, corresponds to the active heat loss in the middle latitudes. From the point of view of the Gulfstream dynamics, in the first case, an intensification of the current must be expected and, in the second case, the weakening of the current or strengthening of the recirculation cell must occur.

The non unique regime of MHT in the middle latitudes, accompanied by the formation of the SST anomalies in the Gulfstream delta area what was shown by Lau, Nath) (1989) analyses of the North Atlantic SST data. In its turn a strong

correlation between SST anomalies and the North Atlantic index exists (Bjerknes, 1964).

The intensive flow of the western boundary currents towards the north is possible only in case of developed deep convection in the high latitudes, which allows to compensate the input of water masses in the upper layers by sinking it redirecting it backward in the deep layers.

It is important to notice, that the study of MHT must go together with consideration of MFWT, especially in the high latitudes. Accounting that the atmosphere of both hemispheres carries the water from the tropical zones towards the poles and the equator, a compensating MFWT must exist in the ocean, in form of low salinity waters movement. All the methods of estimating MFWT have substantial deficiencies, as a result the estimates of different scientists do not coincide even in the direction of the transport (Dobroluybov, 1991). Never the less, there is no doubt that the MFWT in the ocean plays a vital role in the climatic changes of the ocean-atmosphere system by defining the buoyancy flux in the source regions of deep and intermediate water (because the contribution of the salinity anomalies to the density at low temperatures overwhelms the temperature anomalies contribution).

In connection to the studies of the North Atlantic role in the climate variations the following questions concerning the MHT and the MFWT must be answered:

- What are the real values of cross equatorial MHT in the Atlantic ocean?
- What mechanisms form the mean fluxes and its variability in different latitudinal zones?
- How are the MHT anomalies in the North Atlantic related to the salinity anomalies in the source regions of deep water masses?
- What are the real values of MFWT in the Atlantic ocean and its interannual variations?
- What is the physics of interaction between MHT and MFWT in different latitudes?

### **SST and Surface Salinity**

The SST all by itself is an important parameter of the ocean. More to this, the processes that lead to the climatic variations in the ocean circulation and variations in the upper layer heat storage are reflected in SST. More to this the SST is an important factor in producing the heat and water exchange between the ocean and the atmosphere. From the point of climate, the most interesting feature is not the mean SST fields, but SST anomalies. recently conducted diagnostic studies of large-scale atmospheric processes (Dymnikov, Filin, 1985; Schmits et al., 1987) and model experiments with the general atmosphere circulation models (Palmer, Sun Zhuabo, 1985; Degtayrev, Trostnikov, 1987) have demonstrated strong correlation between the SST anomaly south of Newfoundland and quasi stationary anomalies of atmospheric circulation. This connections is a consequence of eigen oscillations in the atmosphere-upper ocean layer system which can be initiated by

stochastic forcing on synoptical scale localized along the storm tracks over the Atlantic ocean (Dymnikov, Tolstykch, 1989).

A special interest, in purpose of analyses of large scale climatic changes, is in studies of seasonal and interannual variability of the frontal zones. The extreme values of heat exchange are associated with the frontal zones, the zones of thermal contrasts. The characteristics of the frontal zones to high extent determine the position of the cyclone storm tracks.

For the high latitudes, as mentioned above, the most important parameter is the surface salinity. Lazler (1980) analyzed the hydrological data collected on ocean weather station "B", and found good correlation between the time behavior of the surface salinity and integral thermal conditions of the Northern hemisphere atmosphere. The data shows that the violation of the fresh water balance in this region leads to changes in ocean circulation and climate (Broecker, 1990), one of such disturbances occurred in the late 60-s, when a negative salinity anomaly up to  $-0.1 / \text{oo}$  was formed in Greenland Sea and then moved to the North Atlantic (Dixon et al., 1976). The freshening of the water in the region of convection decreases the depth convection, thus isolating the intermediate and deep waters from interaction with the atmosphere, reducing the production of deep waters and, finally, lessening the water exchange between the high and the low latitudes of the ocean and the ocean's climate warming effect.

The objectives in the studies of SST and surface salinity role in climatic system are:

- The study of mechanisms governing the formation of SST and surface salinity anomalies.
- Definition of different processes contribution to variability of the anomalies on different time and space scale in different regions.
- The study of anomalies statistics, and generation of large scale anomalies by the smaller scales.
- The study of the salinity and SST anomalies influence on the depth of the convection in high latitudes.

## **Sea Level**

The high sensitivity of the sea level to changes in the thermodynamic conditions of the ocean on wide range of time and space scales determined it's significant place in the program.

The analyses of level data proves that sea level variations adequately reflect the time dynamics of the ocean climate system. First of all it is clearly seen from the regularity of the sea level behavior in different parts of the World ocean. The tendency of level increasing is accompanied by the quasi periodic oscillations with time periods of climate variations. It is determined that the sea level oscillations of such period are induced by the anomalies of steric heights and so they are good

indication of ocean thermodynamic conditions (Wyrski, 1974, 1975).

The relation between the characteristics of the thermodynamic conditions and the sea level was found in the low latitudes of the North Atlantic (Blaha, 1984), it allows to use the level data for evaluation of the parameters of thermohaline circulation and as tests for numerical models. The character of level variations in the middle and high latitudes of the North Atlantic mainly reflects the processes of ocean-atmosphere interaction (Reva, 1980, which is the significant mechanism of functioning of the climate system in these latitudes.

The important part of the sea level studies under climatic project is the investigation of the different factors contribution to sea level variations. This factors are steric, barogradient and wind. The relative significance of this factors can sufficiently vary from place to place (Reva, 1987, 1988). More to this, the same factor can play a leading part on one time scale and become unimportant on others (Gill, Niiler, 1973; Demchenko, Poleshaeva, 1987; Lappo, Reva, 1989). All these facts, set a special demands to description of the sea level behavior under simple empirical models and in models of global ocean circulation.-

### **Data Management Strategy**

This question is one of the key parts in successful realization of the program. According to scientific objectives of this program, one may formulate basic principles of data management.

### **Data Collection**

It is necessary to determine data types and it's geographical location. One met stress urgent need of hydrological (up to bottom) measurements, sea level observations, marine meteorology, aerology, and current meter measurements. A vital role must be given to chemical properties of the water and paleoceanographic data (concentration of isotopes in ocean waters and sediments columns, corresponding to recent centuries). North Atlantic has to put in centre of attention. All the data must be tested on compatibility, minding that the data sources are quite different. To approach this problem, it seems reasonable to come up with data set of high reliability, that can serve as a basic one for further estimates.

### **Data Managing**

Climatic studies must be provided with a data managing system, that allows to deal with heterogeneous data reflecting the state of the climate system and gives easy excess (in operative mode) to it to all the scientists engaged in the project. The managing system must incorporate two subsystems: global and regional with less data but high operativeness. The purposes of this two components is principally different.

## Data Assimilation

Data assimilation is understood as not only the operative usage of the data set in short-term forecasting schemes, but primarily, as a possibility to use the data in applied and theoretical mate investigations. Here on, computational algorithms and numerical models must be developed, capable of being merged in the data managing system both global and regional. More to this, an urgent need of the development of new methods oriented on dealing with huge volumes of heterogeneous data.

## References

- Bjerkness, J., 1962: Synoptic survey of the interaction of sea and atmosphere in the North Atlantic. *Geophysica Norvegia*, 24, 3, 115-145
- Bjerkness, J., 1964: Atlantic air-sea interaction. *Adv. in Geophys.*, v. 10, 1-82
- Bjerkness, J., 1966: A possible response of the atmospheric Hadley circulation to equatorial anomalies of ocean temperature. *Tellus*, 18, 820-829
- Broecker, W.S. 1974: Chemical oceanography. N.Y., Harcourt Brace Jovanovich, Inc., 214 pp.
- Broecker, W.S., D. M. Peter, and D. Rind. 1985: Does the ocean-atmosphere system have more than one stable mode of operation? *Nature*, V.315, 21-26
- Broecker, W.S. 1990: Salinity history of the Northern North Atlantic during the last deglaciation. *Paleoceanogr.*, v.5. n.4, 459-467.
- Bunker, A.F., 1976: Computation of surface energy flux and annual air-sea interaction cycles of the North Atlantic Ocean. *Mon. Wea. Rev.*, v. 104., 1122-1140.
- Bunker, A.F., 1980: Trends of variables and energy fluxes over the Atlantic ocean from 1948-1972. *Mon. Wea. Rev.*, v.108, 720-732
- Dobrolyubov, S.A., 1991: Estimating the fresh water component of the meridional transport in the ocean. *Meteorologia and hydrological*, 1, 71-78
- Folland, C.K., Palmer T.N., Parker D.E., 1985: Sahel rainfall and worldwide sea temperature. *Nature*, 320, 602-606
- Gordon, A.L., 1986: Interocean exchange of thermohaline water. *J. Geophys. Res.*, v.91, 5037-5046

- Gulev, S.K., and S.S. Lappo, 1986: Zonal climate of the world ocean: Phase Differences, heat flows, interlatitudinal exchange. *Meteorologia and Hydrologia*, n.10, 76-84
- Gulev, S.K., S.S. Lappo, and V. A. Tichonov, 1988: year-to-year dynamics in the integral characteristics of the thermal interaction between the atmosphere and the North Atlantic. *Izvestia academy of Sciences of the USSR, Atmosphere and Ocean Physics*, v.24, n.8, 861-872
- Hasselmann, K., 1976: Stochastic climate models. part 1: theory. *Tellus*, 28, 6, 473-485
- Hastenrath, S., 1980: Heat budget of tropical ocean and atmosphere. *J. Phys. Oceanogr.*, v.10, 159-170
- Hastenrath, S., 1982: On meridional heat transport in the World Ocean. *J. Phys. Oceanogr.*, v.12, 922-927
- Isemer, H-I., and L. Hasse, 1985: The Climate Atlas of the North Atlantic Ocean. Vol. 1.: Observations. Springer-Verlag, 218 pp.
- Isemer, H-I., and L. Hasse, 1987: The Climate Atlas of the North Atlantic Ocean. Vol. 2.: Air-Sea Interactions. Springer-Verlag, 252 pp.
- Lamb, P.J., and A.F. Bunker, 1982: The annual march of heat budget of the north and tropical Atlantic ocean. *J. Phys. Oceanogr.*, v.12, 1388-1410
- Lappo, S.S., 1984: On the reason of the northern heat advection across the equator in the Atlantic ocean. In: Investigations of the ocean-atmosphere interaction processes. Moscow. Hydrometeoizdat, 125-129
- Lazier, J., 1980: Oceanic conditions at ocean Weather Station BRAVO; 1964-1977. *Atmos.-Ocean*, v.18, 227-238
- Levitus, S., 1987: Meridional Ekman heat fluxes for the World Ocean and individual ocean basins. *J. Phys. Oceanogr.*, v.17, 1484-1492
- Manabe, S., Stouffer R., 1988: Two stable equilibria of a coupled ocean-atmosphere climate model. *J. of Climate*, V. 1, 841-866
- Merle, J., 1980: Seasonal variations of heat storage in the tropical Atlantic ocean. *Oceanol. Acta.*, v.3, 455-463
- Palmer, T.N., Sun Zhuabo, 1985: A modeling and observational study of the relationship between sea surface temperature in the north-west Atlantic and atmospheric general circulation. *Quart. J. R. Met. Soc.*, 111, 947-975



- Polonsky, A.B., N.B. Bulgakov. 1989: Meridional heat transport in the Northern tropical Atlantic. report of the Sixth Session of the SCOR-IOC CCCO Atlantic ocean climate studies panel. Kiev. USSR. SCOR-IOC/CCCO-ATL-V13, 31-34
- Rago, T.A., and H.T. Rossby. 1987: Heat transport in to the North Atlantic Ocean north of 32 N latitude. *J. Phys. Oceanogr.*, v.17, 854-871
- Roemmich, D., 1983: The balance of the geostrophic and Ekman transport in the tropical Atlantic Ocean. *J. Phys. Oceanogr.*, v.13, 1534-1539
- Stommel, H., 1980: Asymmetry of Inter-oceanic freshwater and heat fluxes. *Proc. Nat. Acad. Sci., USA.* v.77, 2377-2381
- Wallace, J.M., and Q.R. Jiang. 1988: On the observed structure of the interannual variability of the atmosphere/ocean climate system. In: *Atmospheric and Ocean Variability*. H. Cattle. Editor. Royal Met. Soc., Bracknell. UK, 17-43
- Wirtki, K., and L. Urich, 1982: On the accuracy of heat storage computation. *J. Phys. Oceanogr.*, v.12, 1411-1416

### ROCC Science Working group

Sergey Lappo (chairman) State Oceanography Institute (Moscow)	Alexandr Polonsky Marine Hydrophysical Institute (Sevastopol)
Genrich Alexeev Arctic and Antarctic Institute (St. Petersburg)	Youri Reva State Oceanography Institute (Moscow)
Sergey Dobrolubov Moscow State University (Moscow)	Alexey Sokov State Oceanography Institute (Moscow)
Sergey Gulev State Oceanography Institute (Moscow)	Vladimir Tereschenkov State Oceanography Institute (Moscow)
Sergey Halevsky Main Geophysical Observatory (St. Petersburg)	Jack Tonkacheev State Oceanography Institute (Moscow)
Alexandr Hakshtas Arctic and Antarctic Institute (St. Petersburg)	Igor Yashayaev State Oceanography Institute (Moscow)
	Igor Zveriaev State Oceanography Institute (Moscow)

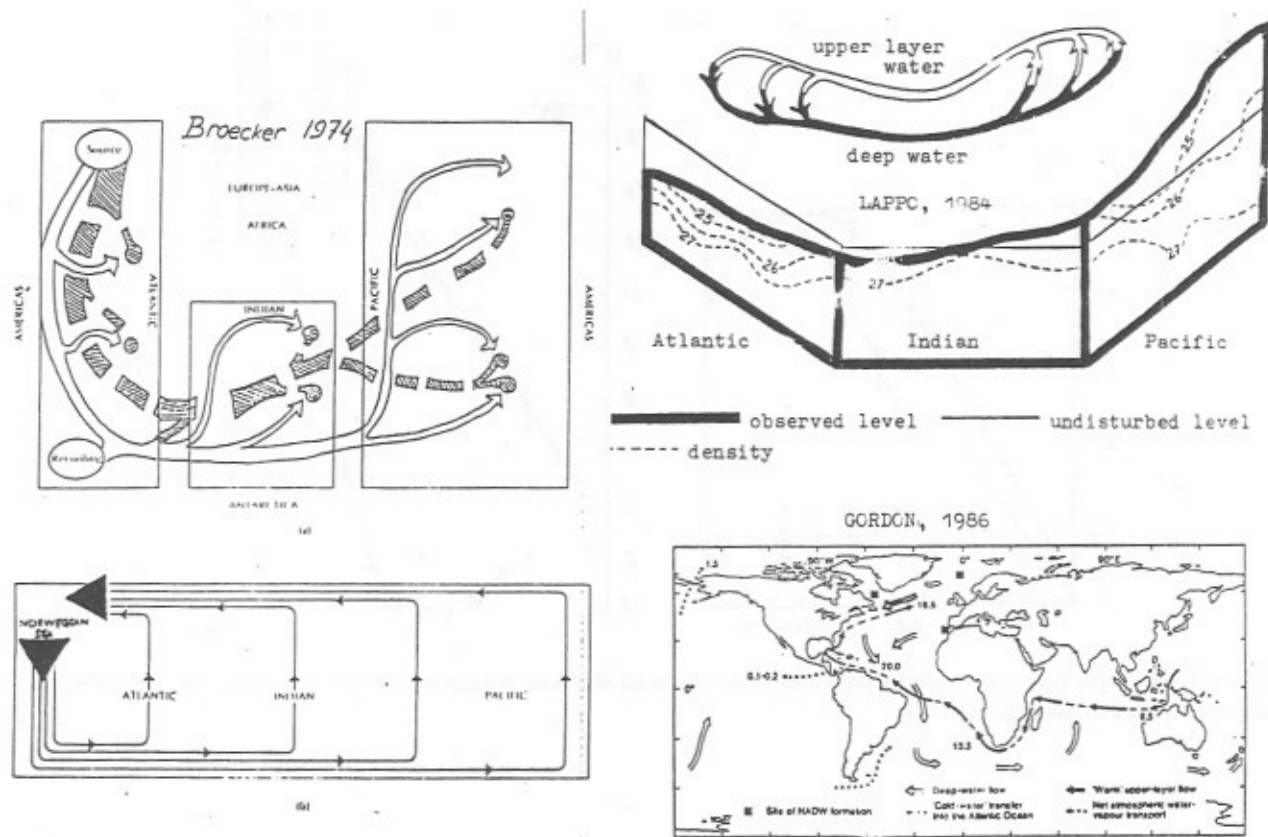

Figure 1. Scheme of "conveyor"—interoceanic circulation (after Broecker 1974, Lappo, Gulev 1984, Gordon 1986)

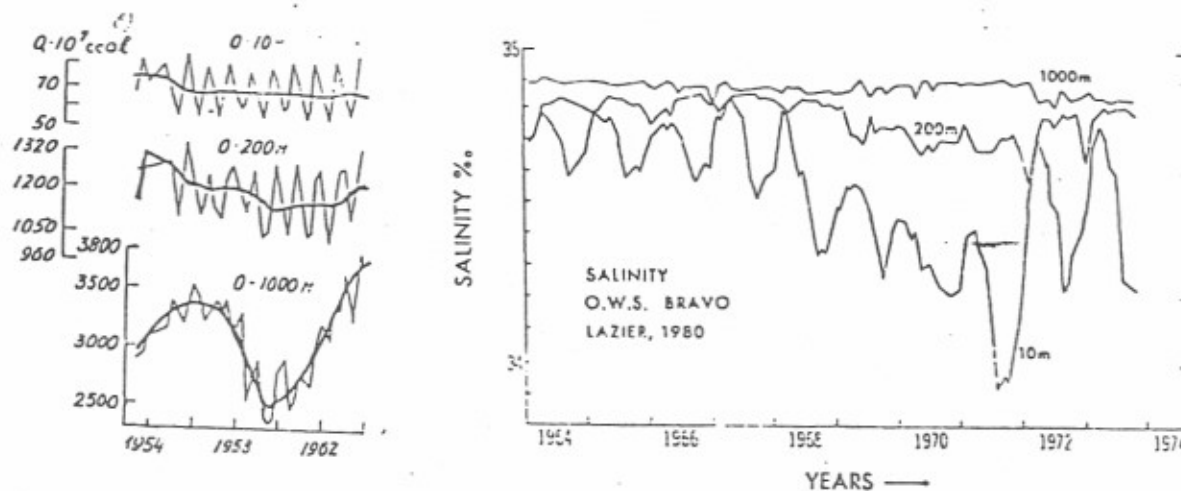

Figure 2. Time behavior of heat capacity and salinity, consequently in North Pacific (Kort, 1974) and North Atlantic (after Lazier, 1980).

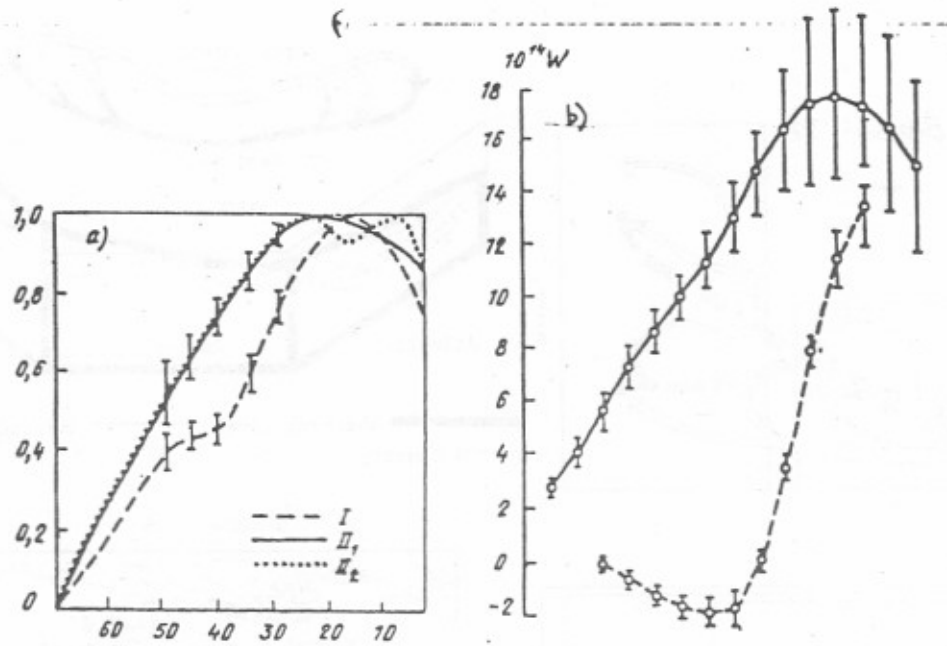

Figure 3. Different types of nondimensional profiles of meridional heat transport in North Atlantic—profiles of mean integral (a) and Ekman heat flux (b).

## **The Role of the World Data Centers in Handling Ocean Climate Data**

---

*Ferris Webster*

### **Abstract**

The World Data Center System, set up for the International Geophysical Year in 1957, is an international network of data centers that links data contributors to data users in the geosciences. It includes means for the synthesis, analysis, and preparation of data products. It was set up in response to the needs of the international scientific community, and is still overseen by non-governmental scientific organizations. Because it is freely available to researchers in all countries, the World Data Center System has a special role to play in support of ocean climate research and monitoring programs.

The World Data Centers face a number of challenges today. Apathy is probably the greatest, since many scientists take the system for granted. There is need to improve access and exploit new technology. The system must establish new links to assure continuity in a world with political changes. The multidisciplinary needs of global change research will demand capabilities for data and information management that go beyond the traditional emphasis on geophysics.

### **Introduction**

Global ocean research programs and ocean observing systems need a robust and open system for collecting, processing, sharing, and archiving the abundant observations collected. The data and the products derived from them must be available to researchers in all countries.

Oceanographers, meteorologists, and other earth scientists are fortunate to have a system already in place for the international archiving, cataloguing, and exchange of data. It's the system of World Data Centers, established more than thirty years ago to serve the needs of the International Geophysical Year. It has continued ever since and today has a positive role to play in handling ocean climate data.

Strangely, there is nearly no mention of World Data Centers in the documents I have seen as background to this Ocean Climate Data Workshop. This is specially curious since this workshop is devoted to the subject of data. I am accustomed to finding data relegated to one of the final pages of any plan for global research. It's said that the emphasis should be on the science. I can't argue with that. However, much of the science will ultimately depend on the effective use of data. Thus I do

argue that an effective science plan will recognize the critical role of preserving and sharing data. In fact, the World Data Center system was established by scientists, to ensure that the vital task of preserving and sharing global data met the needs of scientists.

I would like to take the opportunity of this Workshop to describe what the World Data Center system is, provide a bit of its history, suggest what role it might play in ocean climate research and operational ocean programs, and point out what I believe are the greatest challenges the system faces today.

## **World Data Centers**

"The World Data Center System is essentially a network of Data Centers linking data contributors to data users and includes means for the synthesis, analysis, and preparation of data products."—Guide to the World Data Center System

The World Data Centers (WDC) began as a network in 1957, to serve the needs of archiving and data exchange for the International Geophysical Year. The International Council of Scientific Unions (ICSU) took over the coordination of the system shortly thereafter. The network has functioned ever since, with oversight from ICSU's Panel on World Data Centers. The Centers serve the many disciplines of geophysical sciences and, in the oceanographic domain, include chemical and biological ocean data.

Note that ICSU is a non-governmental organization. The members of the ICSU Panel on World Data Centers are generally not individuals with responsibility for the operation of the system but are chosen from the scientific community.

The centers themselves are generally, but not exclusively, governmental. They are operated at the expense of the host countries, who have volunteered to maintain them. The WDC system thus has an interesting duality: the nationally operated and funded data centers are internationally coordinated by a nongovernmental body responding to the scientific community.

The United States operates a set of centers known as WDC-A, Russia operates WDC-B. China operates WDC-D. A number of centers in Europe, Japan, and India are known collectively as WDC-C. Most world data centers are collocated with related national data centers. In fact, at such centers there is generally considerable integration between the world and national data collections.

The WDCs operate under the terms of the Guide to the World Data Center System (1987). The Guide is reviewed every few years and issued by the ICSU Panel. Among some of the principles set forth in the guide, the world data centers should:

- operate for the benefit of the international scientific community.
- exchange data in all disciplines related to the Earth, its environment and the Sun.
- be completely accessible by scientists in all countries.
- exchange data among themselves.
- be supported by the host countries on a long-term basis.
- be coordinated within a country by the appropriate national committee or scientific institution.

In the USA, the world data centers and corresponding national data centers are:

<i>World Data Center A for</i>	<i>National</i>
Glaciology	Snow and Ice Data Center
Marine Geology and Geophysics	Geophysical Data Center
Meteorology	Climatic Data Center
Oceanography	Oceanographic Data Center
Rockets and Satellites	Space Science Data Center
Rotation of the Earth	
Seismology	Earthquake Information Center
Solar-Terrestrial Physics	Geophysical Data Center
Solid Earth Geophysics	Geophysical Data Center

In general, datasets are duplicated between data centers of the same type. Thus WDC-A, Oceanography, in Washington, DC, USA and WDC-B, Oceanography, in Obninsk, Kaluga, Russia, hold many duplicate datasets. Holding duplicates should assure preservation in case of disaster befalling one of the centers, and improve ease of access for users.

The datasets of most interest to the ocean climate community are held by the WDCs for Oceanography and Meteorology. However, datasets in the WDCs for Glaciology and Marine Geology and Geophysics as well as data available through the WDC for Rockets and Satellites may also be of interest for oceanographic needs.

### **World Data Centers and Ocean Climate Research and Monitoring**

Ocean climate research and monitoring programs have been stimulated by concern over possible changes in the global environment. The programs are of global scale and measurements will be collected by investigators or by operational programs in many countries. The objective of understanding global change will likely only be achieved through collaboration between scientists, possibly of more than one discipline, and probably in more than one region of the world. Under such conditions, access to the datasets by researchers in all countries is of critical importance. Global measurements will be made in many ways, by many different kinds of researchers. If the scientific program is to succeed, an international

system to collect and distribute the data is necessary. The World Data Centers can meet this need.

The World Data Centers are responsible for collecting, distributing, and archiving geophysical datasets. The collecting activity assures that datasets will be aggregated so that maximum advantage can be taken of them. The distribution activity assures that researchers anywhere in the world can gain access to the data. The archiving activity can preserve a long-term environmental record.

### **International Exchange**

“Data held by a WDC must be completely accessible by scientists in all countries, upon written request or personal visit.” —ICSU Guide to the World Data Center System

For climate research programs, the World Data Centers present an valuable opportunity. The centers are already in place, they have experienced personnel, and they cover many of the disciplines relevant to global change research. The centers are international and have a tradition of working together and serving users in all countries. They provide a great base on which to build for the future.

The scope of the World Data Centers fits well with global climate research. Large-scale ocean climate research programs are global in scale. The participation of researchers in many countries is essential. Researchers need to find and share datasets with colleagues in other countries and the WDC system provides a means to meet that need.

The growth of ocean climate research programs in the coming decade will provide the WDCs with an opportunity to show their value. But we must be careful: we can't simply load more requirements on the WDCs and expect them to meet our needs. We should be discussing the role of the WDCs in meetings like this Workshop. There should be dialogue between the operators of the data centers and the planners of ocean climate research and monitoring programs. That dialogue should include a discussion of the role of the data system as well as a review of the resources that will be necessary to implement it.

In many countries (the United States is one) the world data centers generally have no specific budget allocation. They use facilities of the corresponding national center, created to serve national needs. The world data centers may have a limited role and a budget limited to what can be accomplished after national responsibilities are met. If we want to expand the role of the data centers to meet the needs of global-scale research, we ought to be sure that the resources are available.

I believe we should be asking the World Data Centers to meet the needs of international ocean climate research and monitoring programs. Let's put the

World Data Centers into the plans we are now creating. Let's use the World Data Centers to collect, archive, and distribute data and data products for researchers in all countries.

I also believe we should choose World Data Centers over bilateral data-sharing arrangements. There is an increasing use of bilateral agreements for data-sharing between countries, particularly for satellite data. Though bilateral arrangements may be easier to establish, they may not be best for global research. They are generally closed to "outsiders". They are generally set up by governments, and are subject to national restrictions. For true international progress in understanding global climate, we need a system that is international, open to all, and set up to meet the needs of research. The existing World Data Center System fits the bill.

### **Challenges Facing the WDC System**

A number of challenges face the World Data Center System three decades after its creation. The system has worked well during this time. However, unless it continues to evolve to meet changing scientific needs it will likely stagnate and ultimately become irrelevant.

#### **Apathy**

The number one problem is apathy. Many environmental scientists take the system for granted or are unaware of its existence. Scientific involvement is essential. The WDC system will preserve its unique advantages only if the scientific community continues to support it.

If I can send one message to the researchers working on ocean climate programs it is this: Get involved, define your needs for datasets, and work to strengthen the World Data Center System to meet those needs.

#### **Responding to Political Changes**

Political changes in the former Soviet Union are having an impact on the current operations and future outlook for WDC-B. Since it is a key link in the system, WDC-B should be preserved and strengthened. One of the inspiring triumphs of the WDC system was that the principle of free access by all scientists had been respected by both sides throughout the cold war. Current political changes and realignments in the former Soviet Union could jeopardize operations and even the continuity of the data holdings of WDC-B. The international system will be challenged to protect and continue WDC-B.

#### **Multidisciplinary Needs of Global Change Research**

The current WDC system focuses on the igy disciplines. The geosciences have evolved considerably, but only a few new types of world data centers have been



created since the original network was set up. Global change research objectives involve understanding interactions between processes that are traditionally treated by differing disciplines. Thus, to respond to global change research, databases should be incorporated into the system in disciplines so far not covered. Some examples are in terrestrial and oceanic biology, atmospheric chemistry, hydrology, and land processes. As a result of current discussions, I am hopeful that many of these "new" disciplines will be served by world data centers to be set up in the next few years.

### **Strengthen Metadata Standards**

Many important historical datasets are limited by the information we have about them: when they were collected, where they were collected, what instrument was used to make the measurement, what the calibration of the instrument was, etc.

Such information about data is often referred to as "metadata". Without the proper metadata, many datasets are not usable. Nevertheless, nationally and internationally, insufficient emphasis is placed on providing the metadata along with the data. Data centers have too often in the past been negligent in ensuring that the metadata is linked inextricably with the corresponding data.

As we develop stronger long-term climate research programs, the critical importance of metadata will become even more evident. The data centers of the WDC system will be challenged to strengthen the standards for metadata and to ensure their incorporation into standard operations.

### **Data Rescue**

Long-term time series are critical for climate research. A good data point collected fifty years ago could be just as important to establishing climate trends as a data point collected fifty years from now. Consequently, we should identify existing datasets, and assure that they and the corresponding metadata are preserved.

Finding and rescuing datasets is a major challenge. Worldwide, many environmental datasets are in poor physical condition. Datasets are dispersed and many valuable measurements are "lost" and in danger of being destroyed through ignorance of their value. Some data were collected by one-of-a kind instruments. Others have been processed by computer systems that are no longer in existence. As a consequence, these datasets are often in formats that are practically inaccessible.

The world data centers have the opportunity to play a key role in identifying and rehabilitating historical datasets. A major international program of data rescue should be sponsored by the WDC system.

## **Products and Information**

Many users of the WDC system are not simply interested in raw datasets. Rather, they prefer data products or services derived from the data. With the growing interest in the environment, there is an increasing demand for information rather than data. Here again, products or analyses based on datasets are the preferred item. To satisfy this demand, the system should strive to develop new products that respond to the needs of the global change research community.

To go along with this approach, the data centers will have to develop information management capabilities. This change would broaden the role of the data centers and transform them into data and information centers. Incorporating the information analysis role would respond to the evolving needs of the research community and maintain the relevance of the data centers.

## **New Technology**

The system must evolve to incorporate new technology. New means of data exchange and communication are transforming the ability of researchers to find and obtain datasets. New kinds of datasets are emerging, especially from remote sensing, which require new technologies for processing, storage, cataloguing, and distribution. Many of the individual world data centers have taken the lead in showing how these new technologies can be advantageously exploited. Their techniques should be made available to all. In an international network, it is desirable to have the capabilities incorporated into all centers.

Access to the WDC archives should be improved. Letters and visits are no longer the only way for scientists to communicate with data centers. For example, international computer network access is essential. On-line catalog systems should be developed. Data dissemination by diskette, by CD ROMs and by other new technologies should be made standard options.

Ocean monitoring and prediction systems will add a new challenge to the operations of the oceanographic data centers. Oceanographic data centers have traditionally received a relatively small amount of their data from operational systems. This is in contrast to the meteorological data centers, where the bulk of the data is operational. Serving ocean monitoring and prediction programs will call for developing new procedures for data handling and additional ocean data products.

## **Conclusion**

The purpose of this Workshop is to lead to the improved data delivery systems needed by researchers studying the ocean's role in climate change. To meet that end, the ocean science community should incorporate the World Data Centers

into its plans. Along with that, there should be a renewed commitment to the support and improvement of the World Data Centers.

### Appendix: The World Data Center Network

#### WDC-A

Oceanography	Washington
Meteorology	Asheville
Glaciology	Boulder
Marine geology and geophysics	Boulder
Rockets and satellites	Greenbelt
Rotation of the Earth	Washington
Seismology	Golden
Solar-terrestrial physics	Boulder
Solid-earth geophysics	Boulder

#### WDC-B1

Oceanography	Obninsk
Meteorology	
Marine geology and geophysics	
Glaciology	
Rockets and satellites	
Rotation of the Earth	
Tsunami, mean sea level, tides	

#### WDC-B2

Solar-terrestrial physics	Moscow
Solid-earth geophysics	

#### WDC-C1

Earth tides	Brussels
Geomagnetism	Copenhagen
Geomagnetism	Edinburgh
Recent crustal movements	Prague
Solar Activity	Meudon
Solar-terrestrial physics	Chilton
Sunspot index	Brussels
Glaciology	Cambridge
Soil geography & classification	Wageningen

#### WDC-C2

Airglow	Tokyo
Aurora	Kaga
Cosmic Rays	Nagoya
Geomagnetism	Kyoto
Geomagnetism	Bombay
Ionosphere	Tokyo

Nuclear radiation  
Solar radio emissions  
Solar-terrestrial activity

Tokyo  
Toyokawa  
Sagamihara

WDC-D

Oceanography  
Meteorology  
Seismology  
Geology  
Renewable resources & environment  
Astronomy  
Glaciology & geocryology  
Geophysics

Tianjin  
Beijing  
Beijing  
Beijing  
Beijing  
Beijing  
Lanzhou  
Beijing

# **Monitoring Changes in the Ocean and Atmosphere**

---

*Convener - J. Ronald Wilson*

## **Monitoring Changes in the Ocean and Atmosphere**

---

The papers presented in this session provided insight into experiences gained in both field experiments and in modeling in recent years. Both in situ and remotely sensed data were discussed in some detail. The paper on the Global Ocean Observing System (GOOS) gave participants an opportunity to see how some of what we have learned is being applied to GOOS planning and to suggest ways in which these could be improved. The IOC sponsored Ocean PC project added the dimension of distributing data and data products to a large number of countries, especially the developing countries. Dr. Fiuza was able to present the view of an ultimate user of monitoring products and models.

Although the session was primarily aimed at rapid delivery of data from many sources to modelers and to users of contemporaneous data, a number of questions were raised regarding the archiving of data used in monitoring the oceans and resulting model output. Discussions and questions covered a host of topics including data acquisition, communications, quality control, data search and retrieval, formats used and needed, data products and data delivery. A number of the issues and recommendations listed in the "Wrap-up" section of these proceedings were derived from these papers and ensuing discussions.

Although the full text of Dr. Leetmaa's paper is not available at time of publication, he was able to provide us with a summary of his remarks.

## **The Global Ocean Observing System— One Perspective**

---

***J.R. Wilson***

This document presents a possible organization for a Global Ocean Observing System (GOOS) within the Intergovernmental Oceanographic Commission and the joint ocean programs with the World Meteorological Organization. The document and the organization presented here is not intended to be definitive, complete or the best possible organization for such an observation program. It is presented at this time to demonstrate three points.

- The first point to be made is that an international program office for GOOS along the lines of the WOCE and TOGA IPOs is essential.
- The second point is that national programs will have to continue to collect data at the scale of WOCE plus TOGA and more.
- The third point is that there are many existing groups and committees within the IOC and joint IOC/WMO ocean programs that can contribute essential experience to and form part of the basis of a global ocean observing system.

It is particularly important to learn from what has worked and what has not worked in the past if a successful ocean observing system is to result.

This rationalization is submitted to express one person's opinion as to how some of the IOC and joint IOC/WMO ocean service programs might be restructured to better and more efficiently meet the needs of the next decade or so. This rationalization is also intended to provide a more effective development and management environment for the data service programs.

Figure 1 shows the possible organization from a functional point of view. The boxes are referred to below as entities and represent functionality rather than details of organization. They are not intended to necessarily represent IOC or IOC/WMO committees although some of them might best be implemented in that manner.

### **Research Programs Development Entity**

This entity represents the international science programs such as WOCE and TOGA operating essentially as they operate now. The experiments will change with time, but there will be a requirement for this function continuing on into the indefinite future. The function is to organize and operate the international research programs that are needed to develop understanding of the global processes important to climate and global change.

In examining the goals and results of WOCE and TOGA it is always possible to point a finger and say that this or that did not work properly. In terms of final scientific results the jury will be out for some years to come. However both these programs have set an enviable standard for the development and delivery of global research.

TOGA and WOCE have;

- recruited scientific expertise on a global scale and with this expertise have set the program goals, and designed the necessary experiments and supporting data collection networks.
- systematically developed the required data management plans and recruited the scientific organizations and data centres to implement the data flows.
- with the support of scientists in participating countries persuaded national agencies to support global ocean data collection, global ocean research, and global ocean modelling at an unprecedented level.

In short TOGA and WOCE have delivered total global research programs and in doing so have provided a model for very serious consideration in developing a global ocean observing system.

### **GOOS Program Development Entity**

This represents a new entity responsible for the development of international programs to coordinate the implementation of global and regional descriptive and predictive systems based on the knowledge gained from the research programs. Descriptive systems will describe existing and past conditions based on data and models. Predictive systems will describe future conditions based on models simulating ocean processes and assumptions about inputs including anthropogenic activities. This allows the assessment and prediction of change.

This particular function will require a level of research and applied scientific participation equivalent to WOCE and TOGA. The application of scientific knowledge to describe, compare with an earlier situation, to predict into the future based on assumed scenarios, and to maintain an efficient data collection network that measures where needed, is a highly scientific and technical undertaking.

Data and data management have been described from time to time as the heart of a global ocean observing system. If one were to extend the analogy, then this function is the brain of an ocean observing system. It will have to recruit and draw on a base of international research and applied science expertise in the manner that WOCE and TOGA have drawn on their communities. As a research program achieves its results and begins to wind down, its scientists would ensure the conversion of the appropriate portions of the program to an operational or monitoring phase by participation in the work of this entity.



Other functions of this entity would be to continually monitor the performance of the descriptive and predictive systems to ensure they are producing the necessary quality of results, to conduct reviews of the data collection networks to ensure that they are designed to produce the critical measurements and are neither over or under designed. There would be a requirement to work through national contacts to convince countries of the necessity of supporting additional data collection for the global ocean observing system by clearly demonstrating the needs and that the proposed networks were optimized. There would also be a requirement to assess and implement new technologies to better monitor the ocean and at lower cost. The amount of data collection would have to support present and future research programs plus the ocean observing system. Thus the scale of data collection would exceed WOCE plus TOGA present collection requirements. There would of course be a large overlap in data needs between these programs themselves and between the programs and GOOS.

In terms of the size, diversity, and method of working it seems that an equivalent of a WOCE or TOGA IPO working through ad-hoc committees as does WOCE and TOGA is indicated for a global ocean observing system. The entity would interact with the research programs entity to implement observational programs. It would develop requirements and directions for the four entities below on networks, data management, delivery of services, and joint tariff agreements.

There are now three groups involved in aspects of program development related to GOOS. The GLOSS Committee, the IGOSS Group of Experts on Scientific Matters, and the present GOOS Committee are developing elements of the global ocean observing system.

### **Data Collection Networks Entity**

This box represents a service entity that works to implement and manage through international cooperation, the data collection networks necessary to collect the variety of data required by international science and observational programs, ensure the data meet the necessary standards, and that the coverage is adequate. Within the IOC/WMO programs we now have the IGOSS SOOP and DBCP groups doing this function for BATHY/TESAC and drifting buoy data collection programs. SOOP and DBCP are successful. They get their jobs done. They also have contacts and experience that must not be lost to a global ocean observing system. The entity would have to be broadened beyond SOOP and DBCP to deal with a wider range of data types as ocean data collection programs using other sensors were defined. It might also have some responsibilities for instrument testing and certification.

This entity would basically be programmed by the scientific and observational program entities described above who would define the data collection networks. This entity would liaise and cooperate with the data management and communi-

cations entity described below to define the data delivery mechanisms to the data management function.

### **Data Management and Communications Entity**

This box represents a service entity that is not new. It is based on a combination of the IGOSS and IODE committees to handle the real time to delayed mode to historical data exchange/distribution/archival through the existing NODC-RNODC-SOC-WDC structures augmented where appropriate by other centres such as the science portion of the WOCE Data Assembly Centres. The distinction between real time and delayed mode data management systems would gradually disappear. The entity would have additional responsibilities for moving archiving, disseminating satellite data and model data; and for establishing and maintaining an oceans communications network for exchange of various kinds of ocean data not appropriate to the GTS.

Can IGOSS and IODE respond to the development of a global ocean observing system? It seems that it has been demonstrated that they can. Through GTSP and the work of some NODCs and RNODCs IGOSS and IODE have responded to WOCE and TOGA and data is flowing in time frames consistent with data management plans. In the case of IODE there is a need to address more urgently the time frames in which delayed mode data flow through the system. This is being done and in another year it should be apparent whether IODE can deliver. However for the present one has to recognize that these systems have responded.

Some present functions of the two communities could perhaps be moved elsewhere. For example the responsibilities of the IGOSS Group of Experts on Scientific Matters would fit into the international GOOS program development entity. The responsibilities of IGOSS and IODE for delivery of data services to clients, in particular developing countries, could be moved to the scientific data and information services entity proposed below. This new entity might also take on the marine information management responsibilities of the IODE committee.

### **Scientific Data Products and Information Services Entity**

This box represents a new entity to the system. This is suggested as a separate function from the data management function to give it a higher profile and allow the entity to concentrate on delivery of data products and information to clients at all levels from researchers in developed countries to those in developing countries and at time scales from real time to historical. Although both IGOSS and IODE have agenda items at their meetings related to delivery of products and services, this aspect is not well developed. This is due to the fact that the data management problems themselves are complex and demanding and by the time that facet of the business has been dealt with there is generally not much energy or time left for products. On the other hand the Marine Information Management (MIM) group in

IODE tends to concentrate on delivery of information as opposed to data management and is successful in that area. Based on these considerations it seems reasonable to suggest that an entity that is responsible for delivery of data products and information as opposed to data acquisition and management could improve the situation.

### **Joint Tariff Agreements Entity**

This box represents a service entity that is also not quite new. It would be based on the present ARGOS Joint Tariff group but would have additional responsibilities for procuring agreements for the ocean satellites of the 1990s. It could also be responsible for negotiating agreements with common carriers for communications services to meet the needs for an ocean network. This entity is seen as necessary because of the inefficiencies and difficulties now encountered in negotiating with ESA for ERS-1 data on an individual basis. For example WOCE is still uncertain how access to ERS-1 data will be arranged and what it will cost. This is likely to become even more complicated as more satellites with ocean sensors are launched.

In terms of performance, the ARGOS JTA has been successful. It has resulted in reduced costs for users to the ARGOS system, and has benefited ARGOS by reducing the number of groups with which it has to negotiate.

### **Linkages**

The black arrows in figure 1 represent linkages. In the case of the vertical arrows between the research and observational program entities, the linkages are for coordination, advice, and consultation in moving the results of the international experiments from the research to the applications phase. Also some operational and monitoring programs will support further research so that there is a two way flow of support between these entities.

The horizontal arrows represent the flow of requirements from the developmental aspects of the global research and global ocean observing system elements to the data services entities. In the reverse direction the arrows represent the flow of data services, data flow and data monitoring information, and advice from the data services entities back to the developmental entities.

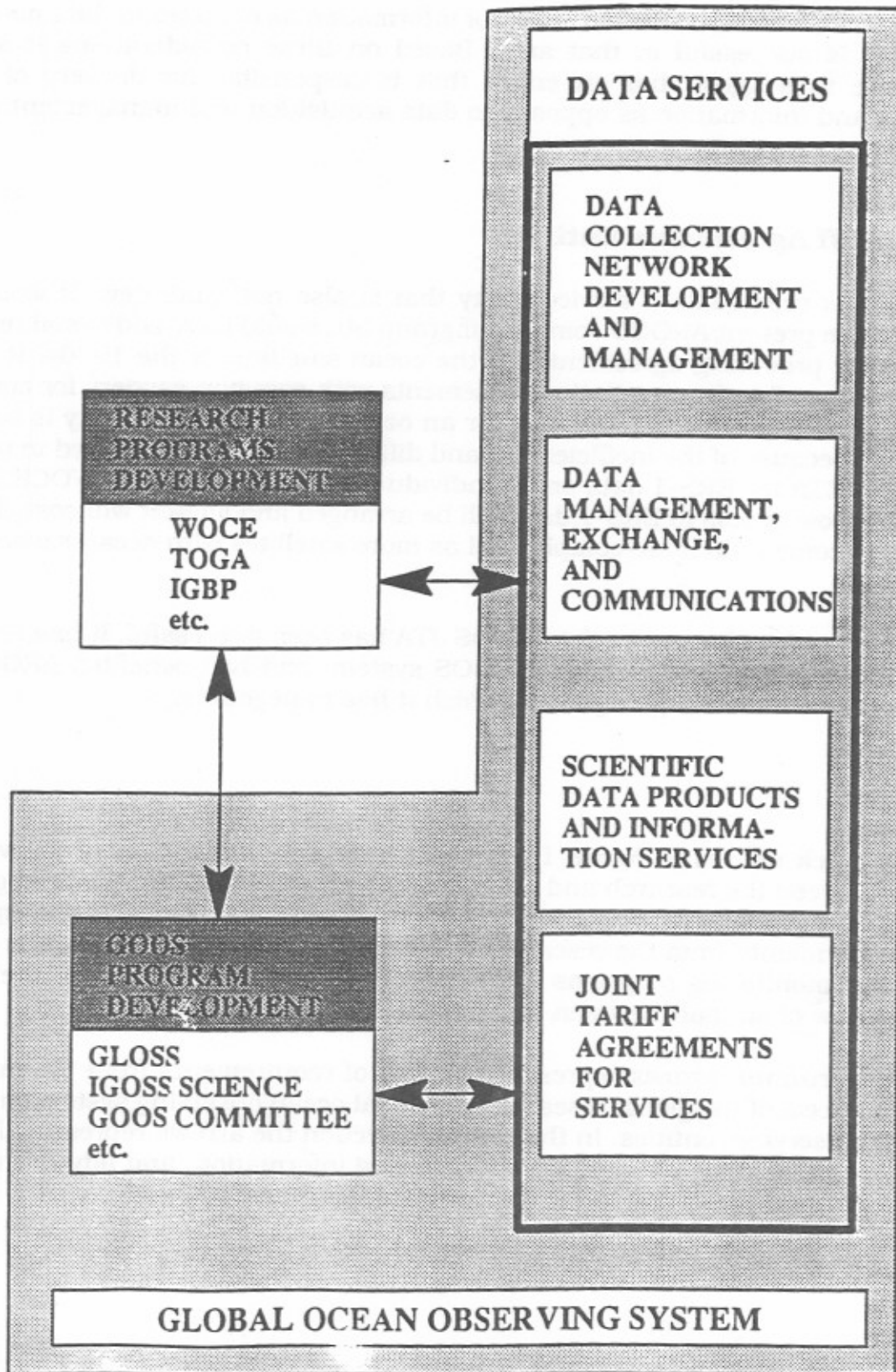

Figure 1. One concept for a rationalization of IOC and Joint IOC/WMO ocean programs in the context of the GOOS.

## **Operational Seasonal and Interannual Predictions of Ocean Conditions**

---

***Ants Leetmaa***

### **Summary**

Dr. Leetmaa described current work at the U.S. National Meteorological Center (NMC) on coupled systems leading to a seasonal to multi-seasonal prediction system. He described the way in which ocean thermal data is quality controlled and used in a four dimensional data assimilation system. This consists of a statistical interpolation scheme, a primitive equation ocean general circulation model, and the atmospheric fluxes that are required to force this. This whole process generated dynamically consistent thermohaline and velocity fields for the ocean. Currently routine weekly analyses are performed for the Atlantic and Pacific oceans. These analyses are used for ocean climate diagnostics and as initial conditions for coupled forecast models. Specific examples of output products were shown both in the Pacific and the Atlantic Ocean.

As part of the development of an operational forecast system, this data assimilation system is being used to retrospectively analyze the ocean fields from 1982 to the present. This data set can be used to diagnose ocean variability during this period and will also serve as initial conditions and verification fields for the coupled forecast system. A separate effort at NMC is undertaking the task of performing a retrospective analysis for the atmosphere for the last 35 years. Both ocean and atmospheric reanalyses will be a recurring process which will be repeated as more data is added and as the analysis system continues to be improved.

Currently much of the information about surface thermal variations in the ocean is derived from satellite measurements. The recent volcanic eruptions can cause serious errors in these estimates, and a solid system of in-situ measurements is needed to correct for such problems. This illustrates the need, while quality control is being performed, of having access to data from different kinds of measurement platforms. At operational centers, such as NMC, accessing diverse data sets from ships, buoys, x-bts, and satellites in realtime is relatively easily done. This timeliness and easy data accessibility facilitates quality control. Data management procedures in the future should stress these principals.

Dr. Leetmaa concluded requesting that data management planners think about :

- (a) multivariate, multi-year data set accessibly - the various ocean and atmospheric data sets being consolidated for climate forecast systems and the dynamical reanalyses produce diverse, already quality controlled, and large data sets. How will these be distributed and by whom?

- (b) the study of annual & interannual variability is central to understanding climatic variability - this requires long time series data for the ocean and atmosphere; data centers can help in this by making a special effort to consolidate whatever historical information is available.
- (c) international cooperation - development of these retrospective analyses for the ocean and atmosphere will be a continuing process and will require an international effort in data assembly, quality control, and verification.

### **Question Period**

Q. As there are changes in the model, is there a need for reanalysis?

A. NMC is in the process of doing this. Ocean reanalysis is not as time consuming as one might imagine.

Q. Are these forecasts used in support of agricultural forecasts?

A. That is a goal

Q. What data types are the most valuable?

A. The main source of information about the ocean at present consist of thermal data from satellites, ships, buoys, and XBTs. In the future sea level altimetry from satellites such as TOPEX and current from drifting buoys will become more important.

Q. How adequate are the data now used for reanalysis?

A. There is some evidence that valuable data needed to complete the historical data sets is not yet available to Data Center, which are the data sources used by forecasting centers such as NMC. Since reanalysis is not that difficult improved historical data sets would be most welcome.

## **World Ocean Circulation Experiment**

---

*R. Allyn Clarke*

### **Introduction**

The oceans are an equal partner with the atmosphere in the global climate system. The World Ocean Circulation Experiment is presently being implemented to improve ocean models that are useful for climate prediction both by encouraging more model development but more importantly by providing quality data sets that can be used to force or to validate such models. WOCE is the first oceanographic experiment that plans to generate and to use multiparameter global ocean data sets. In order for WOCE to succeed, oceanographers must establish and learn to use more effective methods of assembling, quality controlling, manipulating and distributing oceanographic data.

### **Oceans Role in the Climate System**

#### **Major Part of Hydrological Cycle**

It is not always recognized that water vapour plays a dominant role among the greenhouse gases in creating a climate on earth in which life could be developed and sustained. The oceans provide the source for the majority of the evaporation by which water vapour enters the atmosphere. There is also some evidence that salt crystals and sulphur compounds that enter the atmosphere through sea spray also supply condensation nuclei that result in clouds and precipitation. Both these processes are important parts of the atmospheric weather systems; clouds also play important roles in the global radiation balance.

#### **Heat Storage**

The ocean has a much greater heat capacity than the atmosphere. The ocean surface layers have the ability to absorb many days of solar heating during the spring and summer and only warm by a few degrees each week. Only under conditions of low wind speed and shallow and strong stratification in the upper levels can one observe diurnal variations of temperature in the ocean of a degree or more. In contrast, day / night temperature differences of 10 degrees are relatively common in surface soil and air conditions at interior meteorological stations.

This effect is also seen in the seasonal cycle at moderate to high latitudes. Spring warming is delayed by several weeks at coastal stations relative to stations

a few hundred kilometres inland. On the other hand, air temperatures remain higher in the fall months.

Within the climate system, the ocean is believed to serve as one of the principal mechanisms by which a climatic variation is sustained over periods of seasons and longer. The interactions between sea surface temperature anomalies in the tropical Pacific and anomalous weather around the globe have moved from research journals to the nightly weather broadcasts. Mid and high latitude temperature and sea ice anomalies have been linked with anomalies in atmospheric circulations, especially over northern Europe; however, these studies have not been universally accepted by either oceanographers or meteorologists.

At even longer time scales, simulations of the transient response of climate to changing atmospheric gas concentrations has suggested that the oceanic heat capacity slows down the expected global rise in temperature by several decades.

### **Heat transport**

Oceanic processes transport as much heat across meridional circles at mid latitudes (20-30 degrees) as does the atmosphere. A large part of this transport arises through the thermohaline overturning of the ocean. Colder waters flow equatorward in the deeper layers of the ocean and are replaced at high latitudes by warmer surface waters flowing poleward. This overturning is driven by convective processes presently centred on a few high latitude regions in the North Atlantic and its marginal seas as well as in the Southern Ocean.

Oceanic heat transport also arises in the wind driven gyre circulations. In the sub tropical gyres, strong western boundary currents move warm water poleward where it releases its heat to the atmosphere and cools. The cooled waters return equatorward in the ocean interior. The difference in temperature between the poleward flowing boundary current waters and the equatorward flowing waters of the interior result in a net poleward heat flux. Finally, in some regions of the ocean, heat may be transported poleward through eddy motions. This is a dominant mechanism for atmospheric meridional heat transport; however, it appears to be of only second order importance in the ocean with the possible exception of within the Antarctic Circumpolar Current system.

### **Reservoir for Radiatively Active Gases (RAG's)**

The ocean has a great storage capacity for many of the radiatively active gases and thus oceanic processes must be considered when developing models of how the atmospheric concentrations of these gases may have changed over recent historical or geological time. Ocean processes will advect, store and release these gases much as they deal with heat. In addition, biological processes in the ocean will also play roles for gases such as Carbon Dioxide.



## **The Goals of WOCE**

### **Goal 1**

To develop models useful for predicting climate change and to collect the data necessary to test them.

Within Goal 1, the specific objectives are:

To determine and understand on a global basis the following aspects of the world ocean circulation and their relation to climate:

1. The large-scale fluxes of heat and fresh water, their divergences over 5 years and their annual and interannual variability.
2. The dynamic balance of the world ocean circulation and its response to changing surface fluxes.
3. Components of ocean variability on months to years, megametres to global scale, and the statistics of smaller scales.
4. The rates and nature of formation, ventilation and circulation of water masses that influence the climate system on time scales of ten to one hundred years.

### **Goal 2:**

To determine the representativeness of the specific WOCE data sets for the long-term behaviour of the ocean and to find methods for determining long-term changes in the ocean circulation.

Within Goal 2, the specific objectives are:

1. To determine the representativeness of the specific WOCE data sets.
2. To identify those oceanographic parameters, indices and fields that are essential for continuing measurements in a climate observing system on decadal time scales.
3. To develop cost effective techniques suitable for deployment in an on-going climate observing system.

## **The Upper Ocean**

### **Constraining Air Sea Fluxes**

Ocean models can only be validated against observations when one has precise and accurate air-sea flux fields to drive those models. While estimates of all these fields are presently available from climatological surface meteorological data, little is known about the accuracy of these estimates. A WOCE strategy is to use the ocean observations themselves to provide a large scale constraint on these estimates. For example, the transport of the Florida Current is broadly consistent with estimates of the wind stress distributions over the sub tropical gyre of the North Atlantic.

The North Atlantic has a great wealth of surface meteorological data stretching way back into the previous century. Oceanographers have also measured the oceanic heat flux across several latitudes in this ocean. One cannot find any parameterization of the surface meteorological observations that will result in estimates of the air-sea fluxes which are consistent with consistent with the changes in oceanic heat flux estimates from the equator to mid latitudes.

Recently, atmospheric boundary layers have been added to long range forecast models; hence these models should be providing reasonable regular estimates of wind stress and air sea fluxes of heat and fresh water. These models are also assimilating scatterometer data which should also provide better estimates of wind stress directly and the other flux terms indirectly. WOCE has specified a network of XBT sections designed to allow the heat content of the upper ocean to be computed at least bimonthly at a 500 to 1000 km scale. The upper ocean velocity field is also being planned to be measured on the same spatial scales using satellite tracked drifters. Changes in heat content over periods of a few months corrected for the upper ocean circulation will be used to check estimates of air-sea fluxes produced by the various techniques and forecast models.

### **Upper Ocean Circulation**

Most of what is known about ocean circulation has been learned using techniques or data sets that emphasize larger space and time scales. The WOCE/TOGA Surface Velocity Programme is using surface drifters to map the time dependent Lagrangian surface current field throughout the major ocean basins. This program is well underway in the Pacific Ocean and beginning to build in the Atlantic. Satellite altimeters (ERS-1 and TOPEX-Poseidon) will map the sea surface elevation field of the globe every two weeks to a month. Combining the altimetric and drifter data will permit a mapping of some of the mesoscale features of the upper ocean circulation field over the WOCE period.

From estimates of the surface winds through advanced forecast models and scatterometer measurements, measurements of the lagrangian velocity at 15 metres using an instrument whose direct response to wind forcing is both known and small, estimates of the sea surface slopes from altimetry and estimates of the upper ocean stratification from the XBT program, WOCE hopes to get a better understanding of the role that ageostrophic currents play in the transports of mass, heat and fresh water in the upper ocean.

### **The Full Depth Ocean**

#### **Wind Driven Gyre Circulation**

The wind driven gyre circulation of the global ocean is the dominant mechanism by which mass, heat, salt and tracers are transported both meridionally and zonally within the ocean. The basic balances of these circulations have been

understood for the past 40-50 years and good estimates of the strengths of the western boundary components of many of the principal gyres have been made over the past two decades. Eddy resolving ocean circulation models have demonstrated how the eddy field associated with these strong western boundary currents can generate both deep and upper ocean recirculation gyres resulting in western boundary transports much larger than those implied by simple sverdrup integrations of the wind stress across the gyre. There is still difficulty reconciling what we know about the seasonal variation of the wind forcing over a gyre and the few sparse observations of the seasonal variability of the western boundary transports.

The WOCE implementation plan is designed to obtain a global description of the three dimensional distribution of a 'mean' oceanic velocity field that can be used to validation ocean general circulation models. This estimate will be made from high quality eddy resolving full depth hydrographic sections crossing every major ocean basin and gyre both zonally and meridionally, a global deep float release, mooring arrays across every major western boundary current and global satellite altimeter coverage. It is hoped that the hydrographic sections in each ocean basin can be completed in as short a time as possible, ideally over periods less than 5 years, so that long term variations in water mass structure don't complication the dynamical interpretation of the data. In regions where seasonal variability is known to be large, repeat sections in particular seasons are specified. The deep floats will provide an estimate of the lagrangian velocity at a depth of the order of 1500 metres. Averaged over five years and spatial scales of 500 km, this velocity should be accurate to 0.01m/s. The mooring arrays will be set of periods of 1-2 years and will be designed to provide estimates of the mean transports of these boundary currents with an accuracy of the order of 10%.

There is a certain amount of redundancy in the measurements. The strategy is to use inverse methods to arrive at circulations which best fit the ensemble of all the ocean and wind stress data available for the particular ocean or gyre that is being investigated. The WOCE challenge is to ensure that the various individual data sets are assembled, quality controlled, documented and made available to scientists who have not used such data in the past. We are looking to the data management community to develop new convenient ways to encourage this process.

### **Thermohaline Circulation**

The thermohaline circulation is responsible for a significant part of the meridional transport of heat and salt which is so important to the global climate system. Mooring arrays will be set to measure the deep western boundary currents which carry the deep waters away from their high latitude formation regions towards the rest of the global ocean. For the deep and bottom waters, the ocean appears like a series of connected basins. Mooring arrays have been placed in the gaps between these basins to measure the interbasin transports. Finally the global

hydrographic survey described in the previous section will also map the distribution of a variety of tracers.

Our strategy is to again use inversion models starting with the large scale velocity fields estimated for the wind driven circulation and adding information from the tracer distributions, western boundary undercurrent transports, flows through gaps and estimates of the rates of formation of these water masses to gain a better understanding of the roles that advection and mixing might play in the thermohaline circulation

### **Oceanic Eddies**

Through most of the world ocean, WOCE's principal concern with ocean eddies is to design a measurement programme that remove the effects of eddies from estimates of larger scale oceanic phenomena. In eddy resolving ocean models, the eddy dynamics are an important mechanism through which energy and momentum is transferred between the various components of the circulation. How well a model describes its eddy field will be an important test of such models.

The satellite altimeters, surface drifters, hydrographic sections, high density XBT sections mooring arrays and RAFOS floats will all resolve some components of individual eddies. These data will all be analyzed to provide a better description of the distribution of eddies in the global ocean. WOCE has collected statistics from all deep sea moorings with more than 9 months data records as part of this mapping exercise. The WOCE Implementation plan also calls for a limited number long term moorings in regions without any such description; these moorings are not considered to be among our highest priorities.

Eddies are believed to be the principal mechanism through which heat and salt are transported across the Antarctic Convergence zone. Here the WOCE implementation plan calls for eddy resolving mooring arrays both in regions where satellite altimetry has indicated a high level of eddy activity and in those where eddy activity appears reduced. We hope to use satellite altimetry to interpolate the results of two or three such eddy arrays around the entire Southern Ocean.

### **Oceanic Variability**

#### **Interannual variability of water mass formation**

Scientists working in the North Atlantic have noted significant variability in temperature/salinity characteristics of deep and intermediate water masses close to the regions where they are believed to be formed. This means that historical hydrographic data taken over a long period of time cannot necessarily be combined as a single description of the temperature and salinity distribution of an ocean and then used to estimate such properties as the divergence and convergence of heat and salt transport.

WOCE plans call for repeat hydrographic sections to be occupied across the source regions (or overflow regions) for each of the major intermediate and deep water masses in the northern oceans. These sections are to run at the end of each winter's cooling season and as a second priority in the fall at the start of each cooling season. These data will serve two purposes. First, we will have a record over the 5 or so years of WOCE of any variation of the properties of these deep and intermediate water masses near their source regions. This will permit a bit of time space blending of the WOCE hydrographic data set when creating the mean fields for each ocean basin. Second, it will permit the development and testing of models that will have the potential of integrating the ocean over a winter cooling season and predicting the water mass characteristic that is likely to result. Models useful for climate prediction will need to be validated against known climate variations within both the ocean and the atmosphere.

### **Gyre scale circulation variability**

Whenever oceanographers have looked at the detailed hydrographic and dynamical fields in some part of the gyre circulation over periods of months they have seen a variability that appears to be of lower frequency and longer wavelength than oceanic eddies. People have suggested that such variability may be due to the gyre circulation shifting its position slightly without changing its strength. Others believe that it is more likely to be a local variation in the circulation. As part of WOCE Core Project 3, there are plans to carry out quasi simultaneous hydrographic surveys of several different parts of the North Atlantic circulation. These survey would also include hydrographic sections to link this particular regions with the structure of the entire gyre. The basin wide measurements such as floats, drifters and satellite altimetry will also be used to make this links. At present these studies are much better subscribed in the sub polar gyre of the North Atlantic than in the subtropical gyre.

### **Conclusions**

WOCE is a global, multiparameter oceanographic experiment that will rely on an effective data management system if it is to succeed. WOCE will bring together every class of ocean data presently in use. The principal WOCE scientific results are likely to arise from combining different types of data rather than the older oceanographic pattern of a principal investigator making observations in the field and then analyzing those data without the addition of any data collected outside of that particular field part.

## Question Period

Q. Several questions on rapid data dissemination

A. WOCE encourages participants place their hydrographic data in the IGOSS system. They have not insisted that this be done.

Q. WOCE quality standards are very high whereas the last speaker (Leetmaa) indicated that model operators are not terribly concerned about quality. How do you explain this difference?

A. WOCE actually includes both. Woce encourages the use of IGOSS to rapidly disseminate data while some WOCE scientific objectives require a very high degree of quality assurance to meet these goals.

Q. How are WOCE data acquisition being tracked?

A. WOCE uses techniques first developed by the IOC and WMO. It has adapted these and information on what is planned and what has been accomplished is available to all on the OCEANIC system.

Q. How will data be made available?

A. All WOCE data will be placed in the IODE system of World and National Data Centers.

## The Global Ocean Observing System

---

*Dana Kester*

### Abstract

A Global Ocean Observing System (GOOS) should be established now with international coordination (1) to address issues of global change, (2) to implement operational ENSO forecasts, (3) to provide the data required to apply global ocean circulation models, and (4) to extract the greatest value from the one billion dollar investment over the next ten years in ocean remote sensing by the world's space agencies. The objectives of GOOS will focus on climatic and oceanic predictions, on assessing coastal pollution, and in determining the sustainability of living marine resources and ecosystems. GOOS will be a complete system including satellite observations, in situ observations, numerical modeling of ocean processes, and data exchange and management. A series of practical and economic benefits will be derived from the information generated by GOOS. In addition to the marine science community, these benefits will be realized by the energy industries of the world, and by the world's fisheries. The basic oceanic variables that are required to meet the oceanic and predictability objectives of GOOS include wind velocity over the ocean, sea surface temperature and salinity, oceanic profiles of temperature and salinity, surface current, sea level, the extent and thickness of sea ice, the partial pressure of CO<sub>2</sub> in surface waters, and the chlorophyll concentration of surface waters. Ocean circulation models and coupled ocean-atmosphere models can be used to evaluate observing system design, to assimilate diverse data sets from in situ and remotely sensed observations, and ultimately to predict future states of the system. The volume of ocean data will increase enormously over the next decade as new satellite systems are launched and as complementary in situ measuring systems are deployed. These data must be transmitted, quality controlled, exchanged, analyzed, and archived with the best state-of-the-art computational methods.

# Global Temperature and Salinity Pilot Project

---

*Ben Searle*

## 1 Introduction

I am very happy to have been asked to give a presentation on the Global Temperature and Salinity Pilot Project to this group of scientists and data managers since you are the people that will ensure the success of this important project. I have personally been involved with GTSP since the idea for this project was first proposed in 1988 and I am the Australian member of the GTSP Steering Committee.

Data exchange and data management programs have been evolving over many years. Within the international community there are two main programs to support the exchange, management and processing of real time and delayed mode data. The Intergovernmental Oceanographic Commission (IOC) operate the International Oceanographic Data and Information Exchange (IODE) program which coordinates the exchange of delayed mode data between national oceanographic data centres, World Data Centres and the user community. The Integrated Global Ocean Services System is a joint IOC/World Meteorological Organisation (WMO) program for the exchange and management of real-time data. These two programs are complemented by mechanisms that have been established within scientific programs to exchange and manage project data sets. In particular TOGA and WOCE have identified a data management requirement and established the appropriate infrastructure to achieve this. Where does GTSP fit into this existing frame work.

For a number of years individual data centres and scientists have been thinking about the benefits of developing centralised continuously updated oceanographic data bases covering the global ocean. In the past there have been a number of barriers stopping the implementation of this dream. In particular the state of computer technology and the relative immaturity of communications systems have long prohibited such a concept. However, today these technologies have reached a level of sophistication and stability that allows us to address these problems.

Another important advance that has brought us closer to the realisation of a truly global database is the increased level of cooperation that has evolved out of necessity for global scale data collection and research programs. With an increasing emphasis on climate change and assisted by improvements in technology these large scale research projects are becoming common and the development of global ocean databases is finally feasible. The Global Temperature and Salinity



Pilot Project has evolved from the need for an improved data delivery system to support the global research effort.

## 2 History of GTSP

At a Meeting of Experts on IODE/IGOSS Data Flow held in Ottawa in January, 1988 data management experts from several countries were looking for ways to promote and improve data exchange programs. A suggestion was made that a global scale data base of ocean thermal data that was freely available and of a high quality would provide the most effective means of promoting data exchange. The development of this database and its dissemination to the scientific community would demonstrate the advantages of participating in data management programs.

As a result of the Ottawa meeting and through the endorsement of the participants at the February 1988 Wormely meeting of Experts on RNODC's and Climate Change and through other meetings held in the United States it was realised that the global data set concept should be developed into a pilot project.

In November, 1988 a proposal on a global pilot project was presented to the IGOSS V Committee by Canada and the USA. This proposal differed only slightly from the plan developed earlier that year in Ottawa with the inclusion of salinity as a second parameter for the global data set. The addition of salinity resulted from discussions held at various meetings between the scientific user community and the data management agencies including the NODC/ERL Workshop on Ocean Data Files in the US during June, 1988. As a result of the Canadian and US proposal IGOSS adopted Recommendation 4 which strongly supported GTSP.

To formalise the project and start planning and development two ad-hoc meetings were held in 1989. The first was in Washington during January, and provided the forum to discuss many of the technical issues and examine potential problem areas. The main area of contention, which seems to occur at most data related meetings, involved the quality control component of the project. This issue was discussed in detail but complete agreement on this complex problem could not be reached. However, the meeting did define the goals and the major elements of GTSP.

A second ad hoc meeting was held in Ottawa in July, and further progressed the project. Participants from existing research programs such as TOGA and WOCE provided their thoughts and experiences on oceanographic data management. The relationship between GTSP and other existing research and data exchange programs was also discussed at great length. At this meeting it was stressed that GTSP would complement and support existing data flow mechanisms such as IGOSS and IODE. It was also agreed that the most significant user group would constitute scientists working within elements of the World Climate Research Program (WCRP) such as TOGA and WOCE. The need for close dialogue

with all related scientific areas during the initial development and throughout the operation of the project was stressed.

Prior to IODE 13 in New York in January of 1990 a workshop was held to gain input from a wide range of marine scientists and data managers to further refine the projects development. At this meeting the terms of reference and composition of a Project Steering Committee were developed. The draft Project and Implementation Plans were reviewed. The concept for a pilot project was presented to the IODE Committee and was well supported.

As a result of these various meetings and with considerable liaison with the scientific community GTSP was born. To date there have been two meetings of the Steering Committee. The first was held in Brest, France during September, 1990 and the second was held in Obninsk, USSR during July, 1991. By this time a considerable effort had already gone into the planning and aspects of the implementation of the project.

During the initial planning of GTSP we were able to call on the experience of the US NODC who had recently established the Joint Environmental Data Analysis (JEDA) project with interested scientists from the Scripps Institute of Oceanography. JEDA developed from the need to involve science in the data management cycle, a weakness that was becoming more apparent as the demand for high quality data increased. JEDA revolves around the exchange of data between NODC and Scripps, with Scripps undertaking scientific evaluation of the data sets to determine their validity. A number of techniques are employed to check the data and as a result various products are developed. JEDA has proven to be a very successful concept.

### **3 Aims of GTSP**

GTSP is aimed at addressing some of the problems that exist in present data exchange and management structures so that data delivery systems suitable to meet the demands of the 1990's can be provided. This pilot project is using a number of previously untried techniques and is taking full advantage of developing technology in data processing systems and communications. It will prove or perhaps disprove technologies and procedures necessary to effectively manage oceanographic data on a global scale.

GTSP will build on the existing data management structures such as IGOSS and IODE and provide a testing ground for proving new methodologies and procedures. GTSP is an exciting project that has already proven to be a successful venture of cooperation between data management and scientific agencies from a number of countries. As it continues to develop GTSP will provide the global marine community with a data exchange and management capability that will be the envy of other physical sciences. We have one advantage over other disciplines. GTSP is based on the collective experience of a number of data managers and

scientists but is starting from a fresh perspective with the advantage of modern technology which has only become relatively stable and robust in the last two or three years.

#### **4 Objectives and Goals**

GTSP has a number of specific objectives which include :

1. To create a timely and complete data and information base of ocean temperature and salinity data of known quality in support of the World Climate Research Program (WCRP) and of national requirements.
2. To improve the performance of the IOC's IODE and the joint IOC/WMO IGOSS data exchange systems by actively pursuing data sources, exercising the data inventory, data management, and data exchange mechanisms as they are intended to work and recommending changes where necessary to meet national and international requirements.
3. To disseminate, through a widely distributed monitoring report, produced on a regular basis, information on the performance of the IODE and IGOSS systems.
4. To improve the state of historical databases of oceanographic temperature and salinity data by developing and applying improved quality control systems to these databases.
5. To improve the completeness of these historical databases by the digitisation of historical data presently in analogue or manuscript form and by including digital data not presently at a World Data Center (WDC).
6. To distribute copies of portions of the database and selected analyses to interested users and researchers.

Since GTSP became operational an aspect of each of these objectives has been realised. As the pilot project continues and broadens to cover other identified activities it will move closer to fully meeting its objectives.

#### **5 Structure of GTSP**

GTSP consists of three main elements: 1) the data management component, 2) quality control, and 3) data flow.

##### **5.1 Data Management**

The data management component consists of the two main centres which are MEDS and the US NODC. MEDS is the focal point for real time data and undertakes the GTSP Quality Control checks on data received via GTS sources on a daily basis. NODC is responsible for the management of the main GTSP database which is a Continuously Managed Database and incorporates both real time and delayed mode data streams. The real time data stream comes to NODC on a weekly schedule after initial quality control at MEDS and delayed mode data comes via existing IODE sources.

## 5.2 Quality Control

On a monthly basis NODC produce data sets for the three ocean basins and these are made available to three scientific centres. Each month data for the relevant ocean region is checked by Scripps Institute of Oceanography, the Atlantic Oceanographic and Meteorological Laboratory and Australian Bureau of Meteorology Research Centre. Flags relating to data quality are returned to NODC for incorporation into the Continuously Managed Database

## 5.3 Data Flow

The communication of data and issue of products is an important part of GTSP. The capture of data is generally through the existing data exchange programs particularly IODE and IGOSS. However, data is also acquired directly from the various scientific programs through their data exchange mechanisms.

Real time data is transmitted by the WMO's GTS which is supplemented by NASA's SPAN network between the US and Canada. SPAN is also used to transmit the monthly data sets to the scientific centres responsible for quality evaluation. Delayed mode data will be acquire through the existing IODE channels and from the relevant WOCE and TOGA Data Centres. Other components of GTSP such as time series data will be implemented as resources allow.

The initial priority of GTSP was to establish the data flow for real time data to support operational activities. This has now been effectively implemented and efforts are proceeding well for the commencement of the delayed mode data stream. This stream will involve the WOCE Upper Ocean Thermal Data Assembly Centres who will be responsible for the detailed scientific evaluation of this data set. It will be the task of NODC to integrate both data sets to form the complete database.

The inclusion of historical temperature and salinity data that has not already been incorporated in exchange programs is vital for the study of long term trends and changes in the ocean. A number of initiatives are underway to capture data that is generally in an analogue form. Many agencies including the Japanese Oceanographic Data Centre, ICES, MEDS, US NODC and USSR NODC are aiming to actively track down and digitise manuscript or analogue data sets. Australia is investigating means of acquiring data presently outside the normal exchange mechanisms both from within the country and from around the South East Asian region. The capture of these data sets by GTSP will result in adding tens of thousands of observations to the global data base.

## 6 Benefits of GTSP

GTSP has an obvious large scale objective, but it is also intended that participants will benefit at local, national and regional levels. GTSP will provide

benefits to the user community through the improvement of data management in a number of general areas. The project is attempting to:

1. Increase quantities of temperature and salinity data;
2. improve timeliness in distributing data to the User Community;
3. standardise the quality control procedures;
4. produce regional and global data products;
5. standardise data formats;
6. introduce new methods and technology in communications, quality control and data management and the progressive transfer of this to all areas of the marine community; and
7. provide a framework for future data delivery systems covering other data parameters.

### **6.1 GTSP Will Increase the Quantities of Data Available**

It is common knowledge that not all oceanographic data collected at sea finds its way into national or international archives. Data is lost at many points in the cycle including at sea, in the coding of radio messages, in scientists filing cabinets, in communication systems and in data management activities. A significant result area of GTSP is the reduction of data loss in all components of the data cycle, particularly communications. The improvement in communication techniques will increase the data flow and providing more data to the end user. The TOGA Subsurface Data Center in Brest provides a good example to illustrate the benefits of improving communications. TOGA is continually refining its data flow mechanisms and this has shown excellent results.

As a general trend the transmission of data to the TOGA Center has increased from less than 10,000 XBT observations per year in 1985 to over 17,000 per year in 1987. Also, the time taken for the higher resolution delayed mode data to replace the near real-time data is steadily being reduced.

GTSP has already been able to increase the quantity of real-time data available to the world's research community through the acquisition of GTS data from three GTS nodes. By using the access to GTS links from MEDS, the US National Weather Service and the US Navy's Fleet Numerical Oceanography Center, the project is able to capture a greater quantity of data than available to each center individually. The data from each of the three GTS nodes is acquired electronically by MEDS where all duplicates are removed.

By using this approach MEDS has been able to capture data that previously may have been lost. A future aim of GTSP is to incorporate other GTS nodes from Europe, Asia and Australia. As these centres begin to provide data a larger number of real-time observations will become available for operational users. Given the relatively low quantities of data presently available in some areas such as the Indian Ocean, Southern Ocean and South Pacific it is crucial that every effort is made to ensure that each observation collected becomes available for global research. GTSP has been able to demonstrate that data losses through

communication difficulties can and have been avoided. Having proven this, GTSP will attempt to implement these procedures on a wider scale to further reduce data losses.

An additional benefit of this approach to data capture is the ability of GTSP to more accurately monitor data flow through existing channels. This monitoring system is used to identify gaps in the global dissemination of data via GTS. Monitoring within GTSP has already identified some major discrepancies in the quantities of data received by GTS Centers throughout the world and as a result efforts can be made to rectify the transmission faults. Improvement in the existing systems has already occurred.

The monitoring program has three main objectives.

1. to assist with the development of duplicate algorithms
2. to identify areas in the communication system that need improvement
3. to acquire the most complete data set

## **6.2 GTSP Will Improve the Timeliness of Data Flow**

One of the aims of GTSP is to improve the timeliness with which data is acquired and made available to secondary users. The first stage of achieving this improvement has concentrated on the real-time data flow which has more operational relevance than delayed mode data.

Increasing the rate at which data is made available will be of considerable benefit particularly to operational users of oceanographic data. As greater quantities and more timely data becomes available for near real time analysis, the reliability and accuracy of operational products will increase. Real-time data available from GTSP is of high quality and quantity than data sets available from any other sources.

## **6.3 GTSP Will Assist in Standardisation of Quality Control Procedures**

The introduction of standardised quality control techniques that have been accepted by the scientific community will be of major benefit to the users of GTSP data. This data set will be of a known standard and quality control indicators will be attached to each observation. Users will be able to examine documentation describing the exact processes used to qualify all data supplied from the GTSP database. Countries without national oceanographic data centers will be able to request data sets from GTSP and pass it to their own research communities with the confidence that the data is of a known quality. The quality control policy adopted by GTSP is that no observational data will be altered. Quality flags are allocated to describe particular tests that the data has been subjected to and the result of those tests is also given to show acceptance or rejection of the feature. However, gross errors occurring in the header details such as incorrect position time or date will be changed if the correct value can be determined with a high level of confidence. For example, a cruise at mid latitudes in the southern

hemisphere may have one observation with a northern hemisphere quadrant identifier. This is obviously a mistake and can be corrected. In this instance a flag is provided to show that a change has been made and the original value is retained in the observation's history. Experience has shown that if only one character can be changed to make a sensible record then the change is most likely accurate. The changing of more than one character is potentially dangerous.

One of the most important aspects of GTSP and a key reason for its success is the introduction of the scientific community into the quality control cycle. GTSP data passes through two main stages of quality checking. The first consists of the tests described in the GTSP Quality Control Manual and the second phase involves scientific agencies with considerable expertise in the water masses of the three major ocean areas. Atlantic data is checked by scientists from the Atlantic Oceanographic and Meteorological Laboratories, Pacific data is checked by Scripps Institute of Oceanography and Indian Ocean data is checked by both the Australian Bureau of Meteorology Research Centre and the CSIRO Division of Oceanography. Why was this elaborate procedure established?

#### **6.4 GTSP Will Incorporate Science into the Project**

During the early discussions on GTSP it was recognised that an area of concern with the existing data exchange mechanisms was the lack of active participation of the scientific community. This situation has in the past lead to a level of suspicion about the validity of data archived in oceanographic data centres.

The success of JEDA has provided the impetus for the other GTSP participants to involve the scientists from their own countries and JEDA confirmed that the development of effective data management systems for the next century required the active participation of the scientific community.

As result of this concept a symbiotic relationship is developing between research organisations and the data management agencies resulting in the development of high quality data sets necessary to effectively conduct research into major global and regional problems. During the 1980s the international data management community realised it could not operate in isolation from research and began the process of becoming more closely linked with the science component of the marine community. For example this Ocean Climate Data Workshop is another in a series of meetings and initiatives that have occurred with greater frequently in the last few years.

Today both the scientists and data managers are realising that they each have an important role to play in the development of high quality and comprehensive global data sets. Each element has specific expertise to contribute but individually each group has neither the resources or the desire to undertake such a large and complex task. Scientists and data managers are now supporting each other within the context of GTSP.

The key element provided by science is the accuracy of the data. Accuracy and reliability are becoming increasingly significant given the delicate nature of major world climatic events such as El Niño and the need to accurately monitor the variables that cause such events.

No previous or existing program has undertaken this integration exercise to the extent being accomplished in GTSP. There have been some difficulties associated with the development of this relationship and these relate primarily to the operational nature of GTSP. Scientific agencies are finding it difficult to justify the allocation of scarce resources to what initially appears to be a monitoring or data management activity. This apparent conflict between science and an operational program has been resolved successfully by the scientific agency integrating the need for GTSP data into their research programs. For example, in Australia the Bureau of Meteorology Research Centre (BMRC) have been developing upper ocean models as part of their contribution to WCRP. Access to GTSP data has provided them with a greater quantity of data of a higher quality to run their models. This improves both resolution and accuracy of the results. An outcome of the BMRC model is a mapping product which in turn provides scientific evaluation of GTSP data. This relationship has developed by integrating aspects of the operational GTSP data into BMRCs research activities.

Research agencies should not be hesitant in becoming involved in GTSP. There is a justifiable role for the research component in the operational activities of this project. If we as a group involved in oceanography are to provide answers to the ocean component of global climate research we must work closely together to produce a useable data set that can be used for research. The scientific community need not change its methods in order to contribute to operational activities such as GTSP but rather they need to be creative when looking to integrate their science activities within the project. GTSP will continue to prove that operational programs and data management activities can successfully be integrated with existing research objectives.

Research funding sources must be shown that the development of global scale, high quality data bases are essential for future large scale research efforts and that scientific participation in the data management cycle can in fact increase the value of research efforts.

## **6.5 GTSP Will Produce A Number Of Products and Services**

To meet one of the more important objectives of GTSP a number of products and services are being developed or are presently available from the projects participants. For example Australia, Canada, France, USA and the USSR are already producing products and services based on GTSP data. A typical outcome of scientific evaluation of data is a mapping product. This type of 'value added' information provides an important and high profile output from the project.



One significant product that is now being planned is the publication of CD ROMs of GTSP data. This will be a major contribution to global and regional programs and will provide countries with limited resources access to high quality global scale data sets. CD ROM technology is rapidly developing into an ideal means of distributing data products and as prices continue to come down this technology will allow many countries' to participate in major international programs. GTSP is planning to release two CD-ROMs. The first will contain temperature and salinity profile data and the second will consist of time series data.

### **6.6 GTSP will Assist in Standardising Formats**

GTSP is presently utilising digital technologies for the transmission and management of oceanographic data. Communications technologies are now allowing the rapid transfer of large quantities of GTSP data between centres. When GTSP was being planned it was anticipated that the WMO digital code BUFR would be used between centres. However, BUFR has not yet been finalised and the standardisation of exchange formats within GTSP is still undecided. However, the difficulty with formats is becoming less of a problem today given the power of computer systems and software to translate one format to another.

### **6.7 GTSP Will Introduce New Technologies**

GTSP is relying on a number of new technologies for the implementation and operation of the project. Within the quality control area there is a greater reliance being placed on powerful computer workstations for the semi-automated checking procedures. Similar systems are used for the mapping analysis and workstations provide the user interface for interpreting, editing and flagging data. The operation of the Continuously Managed Database (CMD) is one area where technology is providing considerable assistance. NODC is in the process of developing a system using a database machine to optimise the performance of the GTSP database. This development project is called Poseidon and was discussed in detail yesterday. Poseidon will provide a system that has very large performance advantages over the more traditional software approach to databases. Communications is another part of the project that has benefited from improved or new technology. The exchange of data between MEDS and NODC is via a high speed data link available under SPAN and with the emergence of global data networks, data centres or scientists from other countries can now relatively cheaply gain rapid access to GTSP data. GTSP will examine new technologies as they are introduced to ensure that the capture and exchange of data and the dissemination of information and products is carried out by the most effective means. GTSP has a high level of flexibility that will allow the introduction of new technologies without requiring major alterations to existing components within the project. The Project is also aimed at transferring new technology to IOC Member States. Implementing GTSP has involved the introduction of 'state of the art' computer applications in the areas of automated and semi-automated quality control, artificial intelligence, graphical data manipulation and presentation, numerical modelling, and data

and information products. The experience gained, expertise developed and standard software packages produced during this project will become available to other countries to assist them in improving their national data management capabilities.

The IOC is developing a concept known as OCEAN-PC which will provide common software for the management and analysis of oceanographic data. MEDS on behalf of GTSP will be coordinating with the OCEAN-PC Project Leader to maximise the potential of the system to deliver data to GTSP and the user. Some of the technology that has developed as a result of GTSP could be incorporated into OCEAN-PC and therefore become available to the wider community.

### **6.8 GTSP Will Assist In Developing a Frame Work for Future Data Delivery Systems**

GTSP has already demonstrated improvements in a number of areas, particularly with the capture of a more complete set of real time data. Developments in the areas of delayed mode data and time series data indicate that they will also prove successful. GTSP has gained a high level of confidence within TOGA and WOCE and this level of acceptance should widen even further. GTSP will still take time to overcome some of the outstanding problem areas and completely implement all aspects of the project. Once this has occurred the project will have been operational for some time and I am confident that it will live up to our expectations. It appears that throughout the 1990s there will be numerous monitoring and data collection programs operating. Each of these will require the support of data managers and scientists to ensure the full potential of the program is realised and no data is lost. The mechanisms developed for GTSP will continue to be enhanced and should be capable of meeting the future requirements for data delivery systems.

## **7 How Can the Scientific Community Assist GTSP**

For its success GTSP relies heavily on the participation of the scientific community at both agency and individual level. Scientists can contribute by ensuring that their data is made available quickly, at least via real time mechanisms. Providing data has caused some concern in the scientific world, because of the fear that the data could be used by other scientists for research purposes. However, real time data transmitted over GTS is at a low resolution and generally only suitable for large scale activities such as mapping or for operational purposes such as supporting fisheries activities. By providing data in real time a scientist is ensuring that at least a low resolution copy of an observation is permanently archived. If the original, high resolution observation gets lost at least some useable information will remain. Data collected by WOCE is being provided in real time although the high resolution observation is not being exchanged for a period of about two years so the scientist can undertake the analysis without the fear of being copied.

The scientific community can further assist GTSP by continually reviewing the quality control procedures and providing feedback on problems. Since the research area will be a major user of GTSP data it is best placed to provide constructive criticism about data quality

## **8 Conclusion**

I believe that GTSP will form the basis of the global data management and exchange systems required in the years to come. It is built on the experience of a number of data managers and scientists and for the first time in international data exchange programs incorporates the scientific community as a significant component of the system. GTSP incorporates these two elements which are essential in ensuring the success of this massive task.

For too many years data managers have worked away with little regard for the needs of the research community who require high quality data sets and scientists have frequently scorned the efforts of the data manager. GTSP is successfully demonstrating that both groups can work together effectively to develop high quality, global scale databases which are needed for the research task ahead.

It is the scientific element of this project that makes GTSP different from other attempts at managing data on a global scale. This is not reducing the role of the data manager who must also bring his experience and knowledge to bear on this problem. We as data managers have a significant role to play in the study of world climate and investigations into the changes that are occurring as a result of natural cycles and human activities. The developing cooperation between science and operationa programs must continue and I am confident that GTSP will be the vehicle for this.

## **Question Period**

Q. What is "Delayed Mode" data? Will it include the types of thermal data sets being produced by WOCE?

A. Delayed Mode is used in this paper as it has been defined by IODE. It is meant to include the high quality data sets that may take quite a bit longer to process. The project does go beyond real time data.

## Indian Ocean Analyses

---

*Gary Meyers*

### Abstract

The background and goals of Indian Ocean thermal sampling are discussed from the perspective of a national project which has research goals relevant to variation of climate in Australia. The critical areas of SST variation are identified. The first goal of thermal sampling at this stage is to develop a climatology of thermal structure in the areas and a description of the annual variation of major currents. The sampling strategy is reviewed. Dense XBT sampling is required to achieve accurate, monthly maps of isotherm-depth because of the high level of noise in the measurements caused by aliasing of small scale variation. In the Indian Ocean ship routes dictate where adequate sampling can be achieved. An efficient sampling rate on available routes is determined based on objective analysis. The statistical structure required for objective analysis is described and compared at 95 locations in the tropical Pacific and 107 in the tropical Indian Oceans. XBT data management and quality control methods at CSIRO are reviewed. Results on the mean and annual variation of temperature and baroclinic structure in the South Equatorial Current and Pacific/Indian Ocean Throughflow are presented for the region between northwest Australia and Java-Timor. The mean relative geostrophic transport (0/400 db) of Throughflow is approximately  $5 \times 10^6$  m<sup>3</sup>/sec. A nearly equal volume transport is associated with the reference velocity at 400 db. The Throughflow feeds the South Equatorial Current, which has maximum westward flow in August/September, at the end of the southeasterly Monsoon season. A strong semiannual oscillation in the South Java Current is documented. The results are in good agreement with the Semtner and Chervin (1988) ocean general circulation model. The talk concludes with comments on data inadequacies (insufficient coverage, timeliness) particular to the Indian Ocean and suggestions on the future role that can be played by Data Centers, particularly with regard to quality control of data as research bodies are replaced by operational bodies in the Global Ocean Observing System.

### Background and Goals

Indian Ocean thermal analyses will be discussed from the perspective of a project which has research goals relevant to variation of climate in Australia. The goals of Australian XBT sampling are motivated by studies showing that variation of climate in Australia depends significantly on sea surface temperature (SST) patterns in the Indian Ocean (Nicholls, 1981; Meehl, 1987). The XBT sampling has consequently been concentrated in the regions where the significant SST anoma-

lies develop. It is worth noting that variation of climate in Asia and Africa also depends on SST patterns in the Indian Ocean (Gadgil et al., 1984; Cadet, 1987, Rocha, 1992).

More than half of the winter rainfall variance in Australia can be represented by two rotated principal components (Nicholls, 1989). The first pattern (Fig. 1) is a broad band stretching from the northwest to the southeast corners of the continent and it is associated with SST anomalies in the Indonesian region and the central Indian Ocean. The second pattern (not shown) is centered on the eastern third of the country and is associated with ENSO. Experiments with atmospheric general circulation models have shown that continental scale rainfall anomalies are most sensitive to SST in the Indian Ocean (Simmonds, 1990). A better understanding of the general oceanography of the Indian Ocean, and in particular the mechanisms that cause the SST anomalies, is required before really useful models for prediction of climate variation in Australia can be developed.

One of the goals of CSIRO XBT sampling is to obtain a ten-year description of the large scale thermal structure and currents in the areas that are critical for Australian climate. Very little historical, subsurface data was available for a climatology, so at this stage we are concentrating on documentation of the mean and annual variation of thermal structure and currents. The thermal features that can be described by XBT observations are the heat storage in the mixed layer and the geostrophic transports of the major currents, as demonstrated in many studies of the Pacific Ocean (Meyers and Donguy, 1984; White et al., 1985, 1989; Meyers et al., 1986; Donguy, 1987, Kessler and Taft, 1987, Harrison et al., 1989; Taft and Kessler, 1991, Picaut and Tournier, 1991). Another goal is to collect the observational data required for testing and verification of Indian Ocean models. A third goal is to provide timely data for assimilation into ocean general circulation models and for initialization of a forward run of coupled models for prediction of climate variations.

### **Sampling Strategy**

Aliasing of small scale variations is a major problem in designing a large scale sampling strategy. The above goals require at least monthly coverage. Features such as eddies, fronts and coastal boundary currents cannot be resolved by VOS XBT sampling on this time scale, and they consequently appear as a high level of noise in the large scale measurements. The question is: How dense should the sampling be in order to minimize the large scale mapping errors, without resolving the small scale features?

Another consideration is that ship routes dictate where dense XBT sampling can be achieved in the Indian Ocean (Fig 2). Our approach was to concentrate the XBT sampling on "tracklines" where merchant ships tend to sail repeatedly along nearly the same route, permitting sampling which is dense in both space and time. Setting the sampling strategy requires specifying the distance between XBT

profiles along the routes and how frequently each route will be repeated. We also need to specify how accurately the large scale, thermal features on the section can be mapped for the chosen sampling rates.

Sampling efficiency curves (Fig. 3) can be calculated from the theory of optimal interpolation to show the relationship of the normalized, squared mapping error ( $E^2/S^2$ ) to sampling density (Meyers et al., 1991; Meyers and Phillips, 1992).  $E^2/S^2$  is mapping error variance normalized by variance of signal. The sampling density is the number of XBT stations per decorrelation scale in an array, which can be distributed two-dimensionally in time and distance along a trackline or horizontally in latitude and longitude. The curves are given for a range of signal to noise ratios ( $S/N$ ) from 0.5 to 3.0. (Note that the curves represent a very large range of variance ratios,  $S^2/N^2$ , from 0.25 to 9.0.) Most of the sampling efficiency curves (Fig. 3) show at first a rapid decrease in error with increasing sampling density, then they become nearly flat at the nondimensional sampling density of 3.0. Thus 3.0 is a cost effective sampling density in the sense that further reduction of the sampling error will require a lot of additional resources for only a small improvement in the mapping error.

For tracklines, this sampling density corresponds to one XBT station each degree of latitude (on nearly meridional sections) and repeat cruises 18 times per year (using the scales in the next paragraph). For a ship traveling at 15 knots a drop every four hours is required, which is usually possible for volunteer observers on ships of opportunity. The accuracy for maps of isotherm depth along the section and in time will be 6.3 m for this sampling density.

The statistical structure required for objective analysis and determination of mapping errors has now been estimated at 95 locations in the tropical Pacific and 107 locations in the tropical Indian Oceans (Meyers et al., 1991; Sprintall and Meyers, 1991; Phillips et al., 1990). Histograms for the depth of the 20°C isotherm show that the statistical structure of the two oceans is remarkably similar (Fig. 4). The space and time scales used for designing a sampling strategy are 3° latitude, 15° longitude and 2 months, and a signal to noise ratio of 0.75. (While a longer time scale might be used in some parts of the Indian Ocean, other areas have a dominant semiannual oscillation which will be undersampled if a longer time scale is used.)

### **XBT Data Management and Quality Control**

Quality control (QC) of the ship of opportunity data at the delayed mode stage is closely supervised by research oceanographers at the Division of Oceanography (Bailey, 1992). A flow chart of the QC procedures is shown in Figure 5. The vertical profiles are checked on a voyage basis for common malfunctions, regional oceanographic features, drop-to-drop consistency along the ship track, and duplicate drops of unusual features (which we encourage our observers to take.) The data are checked against a climatology based on data collected by ships participating in

the CSIRO XBT program. An archive of profiles with unusual features observed along the different lines is used in the QC process. The features are checked with CTD data as opportunities arise.

An interactive editing routine has been set up on the in-house mainframe computer (Silicon Graphics) to edit the data. QC decisions on common malfunctions and real oceanographic features are flagged on the data set (see the Appendix for a list and description of the flags.) The data are further classed (1-4) by depth according to the type of flag associated with the data. Class 1 data is good data. Class 2 data has unusual features, but they are considered to be probably real. Class 3 has features considered to be most likely the result of instrument malfunctions and not real features. Class 4 data are obviously erroneous data.

The data is stored in three archives. The first archive contains the unedited, full resolution, raw data as collected from the merchant ships. The second archive consists of the edited, full resolution data (Class 4 removed). The third data archive has the data condensed to a two meter format (Class 3 removed). This third archive is used for Divisional research, and for the transfer of data to other organisations.

Quality control of the data is considered to start by providing the voluntary observers with continual feedback on why they are collecting the data as well as the results obtained. The two-way communication between observers and researchers inevitably leads to a more carefully collected and generally higher quality data set.

One of my main concerns about data management is that the close connection between researchers and observers will break down as operational agencies replace researchers in the Global Ocean Observing System, and that the quality of the data for research purposes will be decreased. We have already seen this happen in the meteorological community and only recently has the trend been reversed by combining research, operational analysis, modelling, data management and direction of the observing network under one roof at major centers. Perhaps the oceanographic community needs a network of National (or International) Ocean Observatories where all of the work relevant to ocean data and research can be carried out in a coordinated way.

## **Results on the South Equatorial Current and Throughflow**

The XBT tracklines between the Australian northwest shelf and the Indonesian Archipelago provide transects across the headwaters of the South Equatorial Current in the eastern Indian Ocean and the Pacific to Indian Ocean Throughflow. We have prepared a climatology of thermal structure and geostrophic transports on these sections using data collected since 1983 on three tracklines.

**Table 1 Number of Transects**

	1983	'84	'85	'86	'87	'88	'89	Total
Shark Bay-Sunda Strait	5	6	8	13	22	27	24	105
Djakarta-Torres Strait	5	6	8	11	14	16	21	95
Port Hedland-Japan	0	0	0	10	21	15	10	56

The long-term annual mean temperature sections (Fig 6, A to C) show the baroclinic structure. The individual observations were mapped to a uniform grid by averaging in one degree latitude bins, except near continental boundaries where bins reflected the topography. The thermocline slopes upward from Shark Bay to Sunda Strait indicating net transport toward the west, while the shallow isotherms indicate a shear toward the east. North of Port Hedland, a ridge in the thermocline at 8.5 deg S indicates eastward flow on the northern side of the Indonesian Archipelago and westward flow on the southern side. The zonal section across the Banda Sea indicates southward flow in the Makassar Strait, and southward flow again between Alor Strait and the Arafura Shelf. The relative geostrophic transport (0/400 db) was calculated for these sections using the mean temperature/salinity (T/S) curves from the global ocean climatology of Levitus (1982). The net transport function (i.e., net in the sense that it shows transport between one end and each other grid points along the track) is also shown with the temperature sections. The transport of significant currents was calculated between the peaks and troughs of the net transport functions, and plotted on a map (Fig. 7). The map suggests a net relative Throughflow of about 5 . (1 Sv =  $1 \times 10^6$  m<sup>3</sup>/sec) feeding the eastern end of the South Equatorial Current. These results are in excellent agreement with the estimates of Throughflow by Godfrey (1989) based on historical T/S data and a model.

An important application of routine XBT sampling is to study time variation of temperature and baroclinic structure. The temperature sections and transports were calculated for long-term mean bimonths (January/February, February/March, etc.). The transports (Figs. 8 and 9) showed that the South Java Current reversed direction twice a year, with a strong eastward flow developing during March-June and a secondary one during October-December. The flow in the South Java Current balances the South Equatorial Current in these seasons so that the net westward relative transport on the Shark Bay-Sunda Strait track is reduced to essentially zero. The maximum relative westward transport occurs during July-October when the Southeasterly Monsoon accelerates the South Equatorial Current. The net southward relative transport across the Djakarta-Torres Strait line is maximum in May-June. The difference between the net westward (Sunda-out) and net southward (Banda-in) transports in fig. 9 shows a distinctive seasonal cycle. During the seasonal cycle, the triangular region of the eastern Indian Ocean bounded by the Indonesian Archipelago, the Arafura Shelf and the northwest coast of Australia acts as a buffer between the Throughflow and the South Equatorial Current, accumulating the warm water during April to June and feeding it into the Indian Ocean during most of the rest of the year.



The mean temperature section and annual variation of relative geostrophic transports on the Shark Bay-Sunda Strait line have been compared to the results of the eddy resolving, global general circulation model of Semtner and Chervin (1988) by T. Qu (Personal communication, 1992). The temperature section (Fig 10) is in very good agreement, except that the model temperature has a deeper and weaker vertical temperature gradient presumably due to the strong vertical diffusivity in the upper water of the model. The annual mean of relative transport across the trackline is 10.8 Sv in the model, in comparison to 5.3 Sv calculated geostrophically from the XBT data and 3.8 Sv in Ekman transports calculated from wind stress. The annual variation of relative transports in the model is in fair agreement with the observed geostrophic transports (Fig. 11), with the model showing the two minima in net westward transport during the Monsoon transitions.

Studies of the surface layer heat budget are usually not possible with observations alone because all of the necessary data are not ordinarily available. One way to study the mechanisms that control the heat budget is to validate models and then investigate the heat budget of the model. A heat budget for the Semtner and Chervin model for the area between the northwest coast of Australia and 13 deg S (Qu, Personal communication, 1992) indicates that the primary control on annual variation of SST is the surface heat flux. However almost half of the fluxes are balanced by advection of oceanic currents (Fig. 12). This suggests that circulation could play a role in the generation of the SST anomalies in some of the critical areas for Australian climate variation found by Nicholls (1989).

### Mapping, Modelling and Data Assimilation

At present modelling and data assimilation for the Indian Ocean is being developed at three organisations (to my knowledge).

**Table 2: Modelling and data assimilation for the Indian Ocean**

<i>Organisation &amp; PI's</i>	<i>Model</i>	<i>Period</i>	<i>Comment</i>
BMRC	GCM-GFDL	1985 to	XBT to be assimilated
R Gardiner-Garden	MOM-Code	1990	Model includes salinity
N Smith	20 levels		
A Moore	2 x 1/2 deg (approx.)		
UKMO	GCM-GFDL	Not yet	XBT to be assimilated
D Carrington	Cox code	started	Model includes fluxes
D Anderson	16 levels	1 x 1/3 deg (approx.)	Model comparisons to Geosat
LODYC	Shallow	1985 to	Comparison to Geosat
P Delecluse	water-	1989	Assimilation planned
C Perigaud	One layer		

Modelling and data assimilation for the Indian Ocean probably will require broad scale mapping throughout the basin. The bimonthly, horizontal distribution of XBT stations which is available through the normal TOGA and WOCE channels is too sparsely distributed for this purpose (Pazan and White, 1991). Mapping errors less than 0.7 standard deviations are achieved only along the TOGA/WOCE XBT tracklines (Fig. 13). Recently, new data sets are available which will substantially improve horizontal coverage. Declassified XBT data from the US Navy provides good coverage of the Arabian Sea and the area off the west coast of Australia. The Japan Far Seas Fisheries Agency has provided BT coverage of the Indonesian and north Australian waters since 1967. These data are extremely valuable for modeling and assimilation and the availability should be more timely.

Data centers could do a great service for the research community if they could assist in providing scientific quality control for these and other data collected by operational (non-research) agencies. The quality control procedure that I described earlier is labor intensive, and the staff in research institutes who are capable of this kind of work are usually fully committed to the processing of data collected by their own research projects. In most countries, research funding and resources cannot be directed toward operational and archiving activities. I recommend that data centers work closely with research institutes to provide scientific quality control, even to the extent of stationing center personnel at institutes for long periods of time to expedite the transfer of expertise required for really good control.

## Questions

Q. A number of questions on what other countries are supplying XBT data.

A. Data from Japan and France are obtained through the TOGA Subsurface Center. Also the U.S. Navy clarified one question regarding data from other navies. The U.S. Navy has released data as referred to in the talk for U.S. vessels only.

Q. Is the sampling adequate for the type of analyses desired? A. Only where we are doing 18 per year is it really adequate.

## References

- Bailey, (1992) CSIRO Ship of Opportunity Program, Internal Document, CSIRO Division of Oceanography, Hobart, 16 pp.
- Cadet, (1987), in Report of the Third Session of the SCOR-IOC/CCCO Indian Ocean Climate Studies Panel, Vacoas, Mauritius 6-10 April 1987, 64 pp, VI annexes.
- Donguy (1987), *Prog. Oceanog.*, 19, 49-85.

- Gadgil et al. (1984), *Nature*, 312, 141-143.
- Godfrey, (1989), *Geophys. and Astrophys. Fluid Dyn.*, 45, 89-112.
- Harrison et al. (1989), *J. Phys.. Oceanog.*, 19, 397-418. ITPO (1990), Tropical Ocean Global Atmosphere International Implementation Plan, Third Edition, International TOGA Project Office, Geneva, 102 pp, 14 append.
- Kessler (1990), *J. Geophys. Res.*, 95, 5183-5217.
- Kessler (1991), *J. Phys. Oceanogr.*, 21, 444-452.
- Kessler and Taft (1987), *J. Phys. Oceanog.*, 17, 97-122.
- Levitus (1982), *Climatological Atlas of the World Ocean*, Professional Paper No. 13, NOAA, Washington, DC, 173 pp.
- Meehl (1987), *Mon. Wea. Rev.*, 115, 27-50.
- Meyers and Donguy (1984), *Nature*, 312, 258-260.
- Meyers et al. (1986), *Nature*, 323, 257-260.
- Meyers et al. (1989), *Design of an Ocean Temperature Observing Network in the Seas North of Australia Part 1 Tropical Pacific Ocean Statistics*, Report 204, CSIRO Marine Laboratories, Hobart, 50 pp.
- Meyers et al. (1991), *Prog. Oceanog.*, 28, 189-218.
- Meyers and Phillips (1992), *TOGA Notes*, 7, 1-4.
- Nicholls (1981), *Mon. Wea. Rev.*, 109, 2435-2443.
- Nicholls (1989), *J. Clim.*, 2, 965-973.
- Pazan and White (1991), *JEDA Center Annual Report on Indo-Pacific Subsurface Thermal Structure—1987*, SIO Reference No. 91-19, 50 pp.
- Phillips et al. (1990), *Design of an Ocean Temperature Observing Network in the Seas North of Australia Part 2 Tropical Indian Ocean Statistics*, Report 211, CSIRO Marine Laboratories, Hobart, 58 pp.
- Picaut and Tournier (1991), *J. Geophys. Res.*, 96, 3263-3277.
- Rocha (1992), *The Influence of Global Sea Surface Temperature on Southern African Summer Climate*, Ph.D. Thesis University of Melbourne, 249 pp.
- Semtner and Chervin (1988), *J. Geophys. Res.*, 93, 15502-15522.

Simmonds (1990), *Austr. Meteorol. Mag.*, 38, 151-161.

Smith et al. (1991), *Prog. Oceanog.*, 28, 219-250.

Sprintall and Meyers (1991), *J. Geophys. Res.*, 96, 10539-10552.

Taft and Kessler (1991), *J. Geophys. Res.*, 96, 12599-12618.

White et al. (1985), *J. Phys. Oceanog.*, 15, 917-935.

White et al. (1989), *J. Phys. Oceanog.*, 19, 1397-1406.

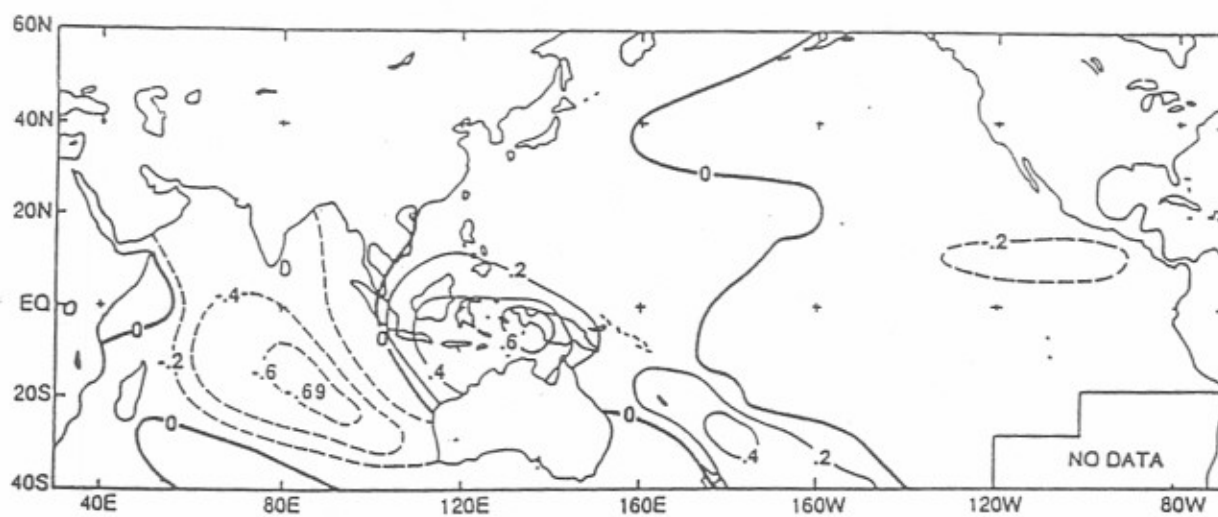
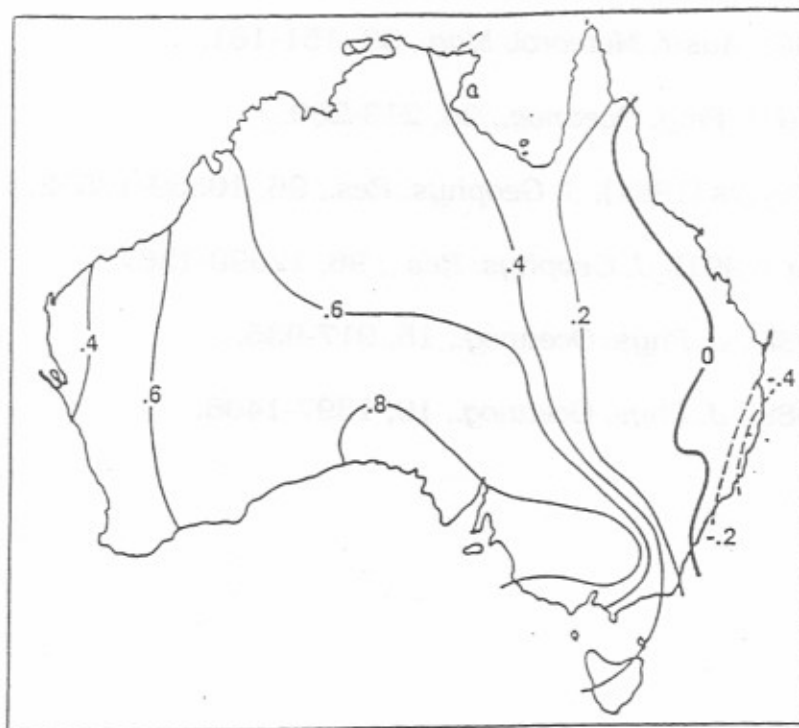

Figure 1. Correlations of district rainfall (top) and sea surface temperature (bottom) with the principal component of Australian winter rainfall (from Nicholls, 1989).

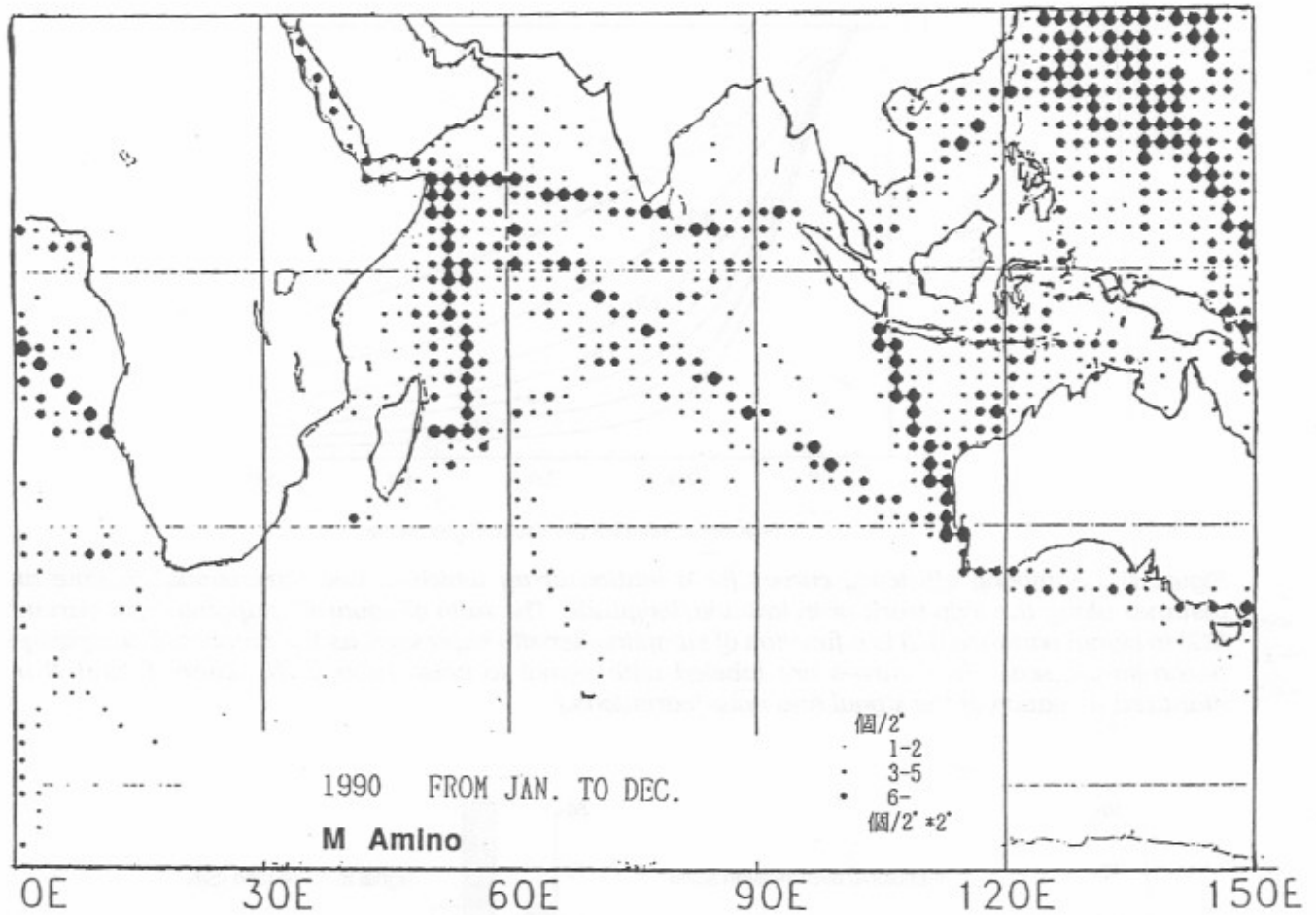

Figure 2. XBT tracklines in the Indian Ocean during 1990. Number of observations per 2' x 2' square: Large dot >6; Medium dot 3-5; Small dot 1-2. (Prepared by Masaaki Amino at the Japan Meteorological Agency from real time data on the Global Telecommunication System.)

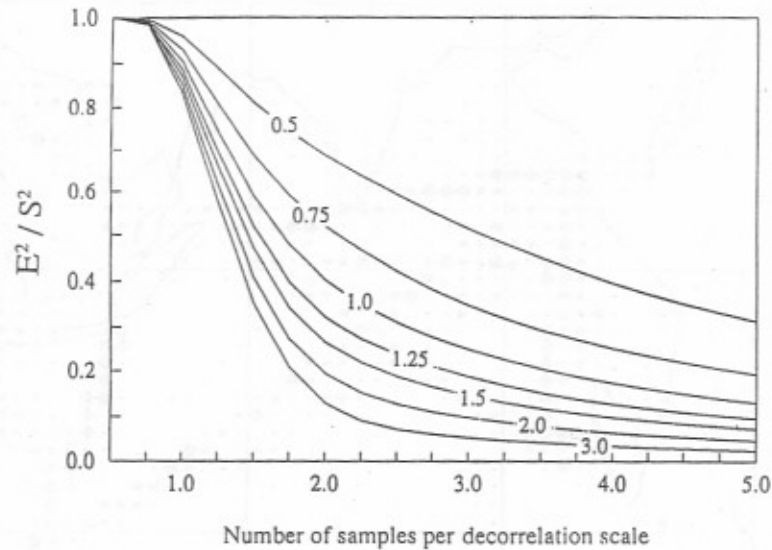

Figure 3. Sampling efficiency curves for a station array which is two dimensional in time and distance along the ship track or in latitude/longitude. The ratio of squared mapping error variance ( $E^2$ ) to signal variance ( $S^2$ ) is a function of sampling density expressed as the number of samples per decorrelation scale. The curves are labeled with signal to noise ratio ( $S/N$ , where  $S$  and  $N$  are standard deviation of the signal and noise variations.)

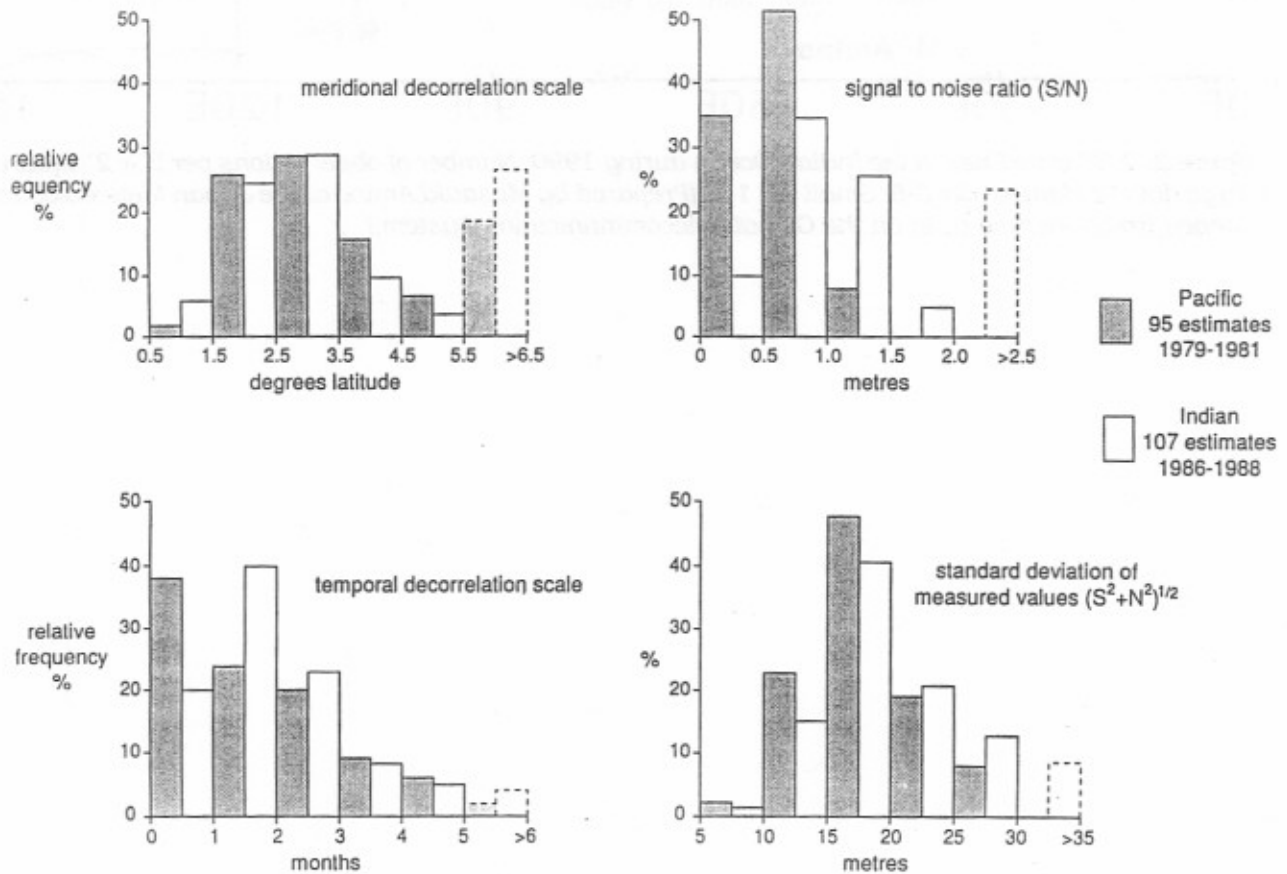

Figure 4. Histograms of the decorrelation scales and variance statistics for optimal interpolation of the depth of the 20°C isotherm for the tropical Pacific and Indian Oceans.

# XBT Data Processing

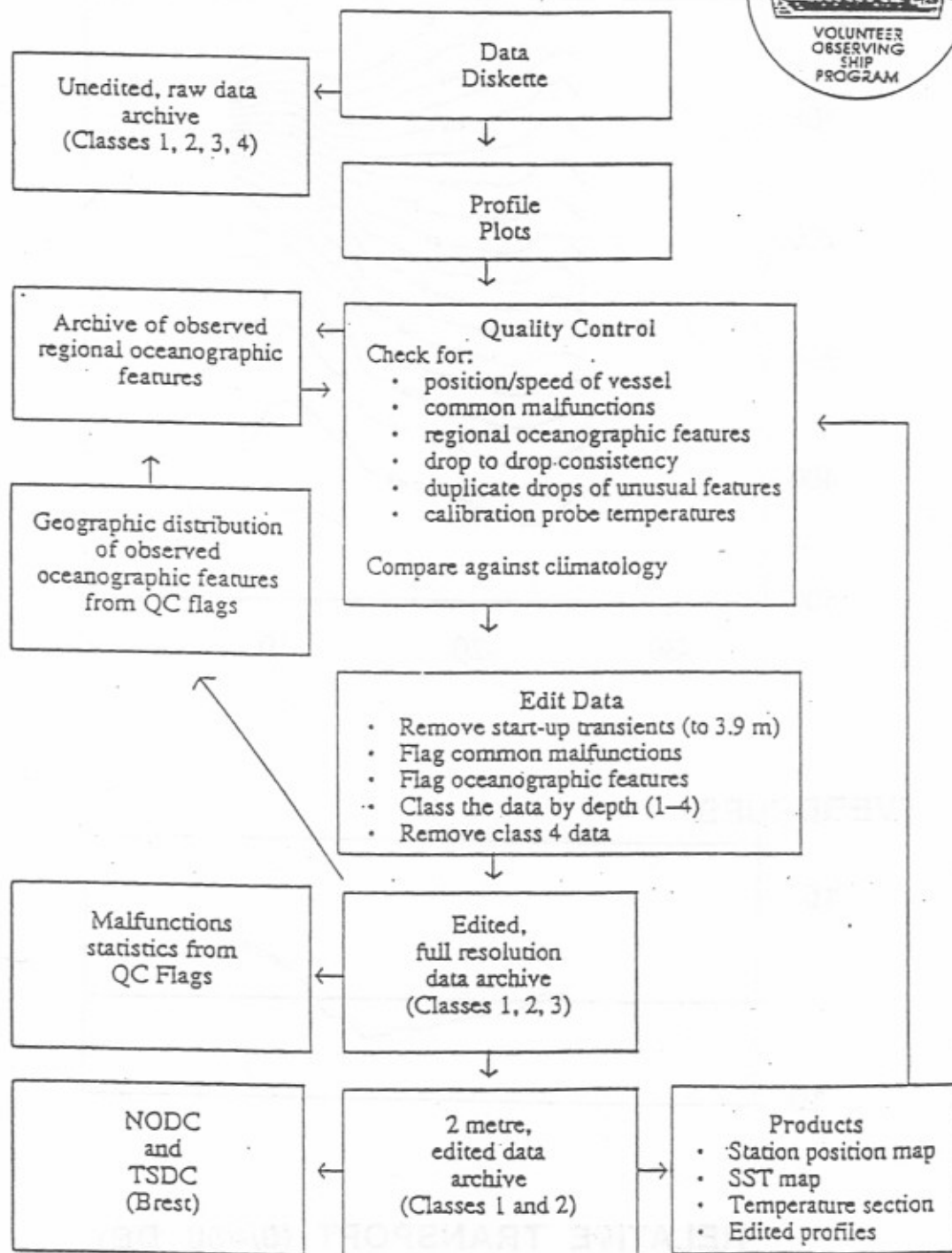

Figure 5. Flow chart for XBT data processing at CSIRO Division of Oceanography (R. Bailey, personal communication)



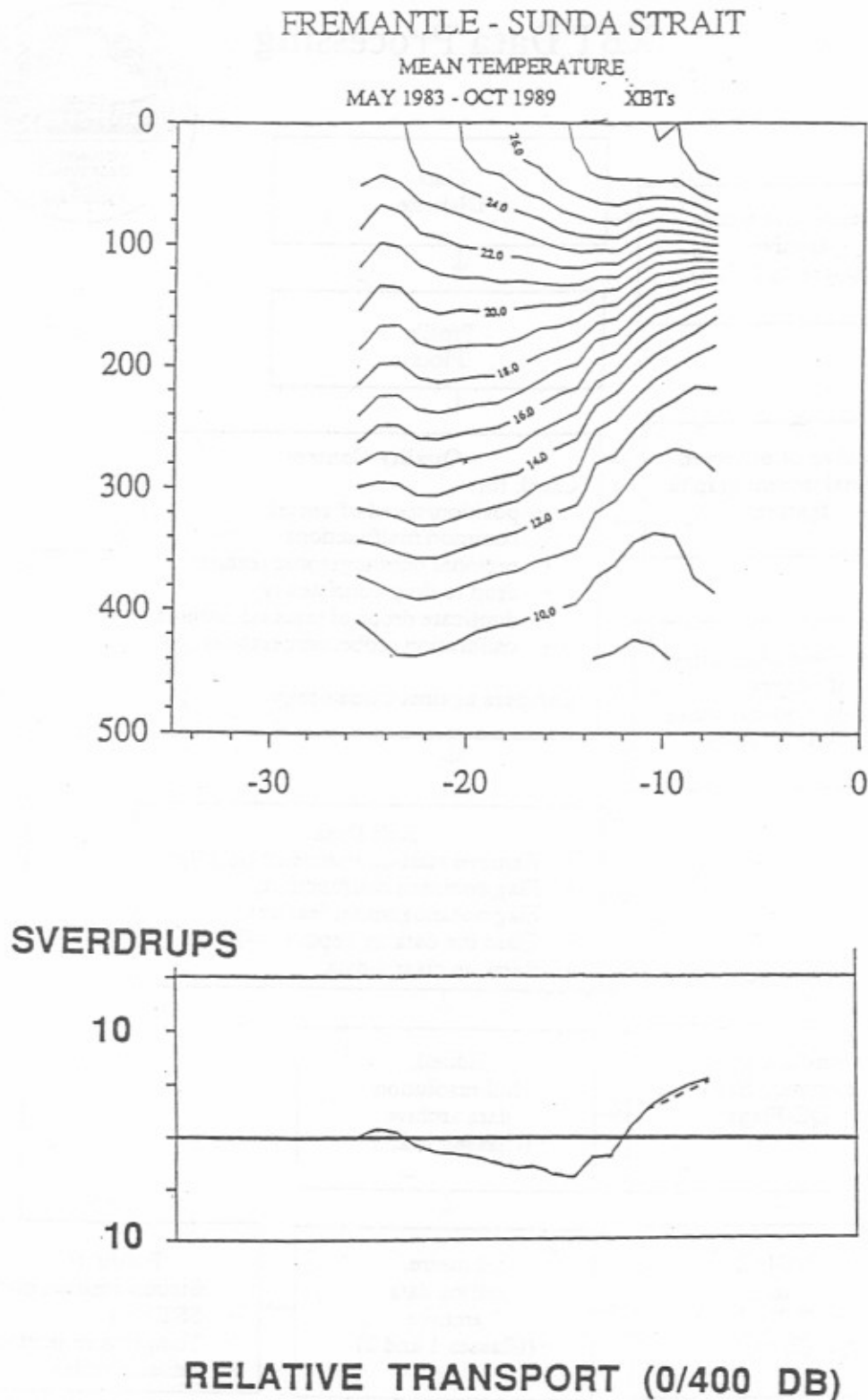

Figure 6A. Long-term mean temperature section from Shark Bay (25.5°S) to Sunda Strait (7°S). The relative transport function (0/400 db) gives the net transport in 10<sup>6</sup> m<sup>3</sup>/s (Sverdrups) between Shark Bay and each point along the section.

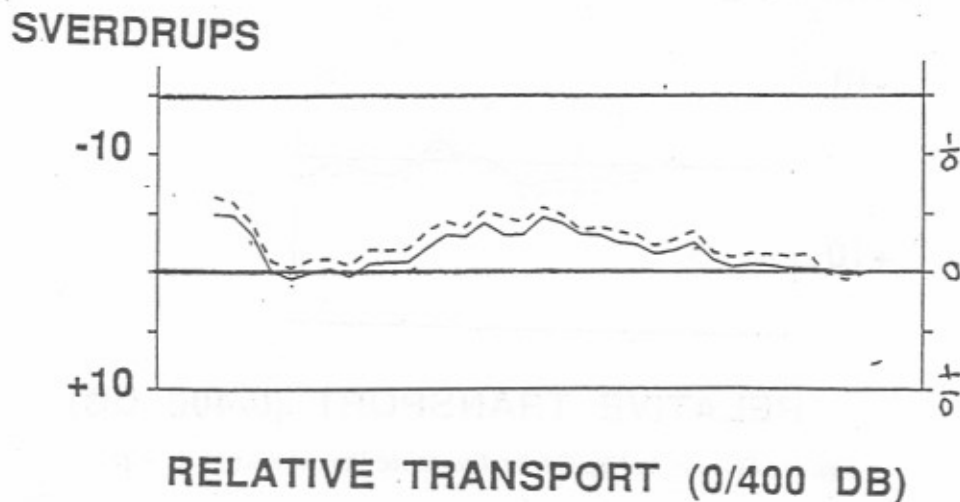
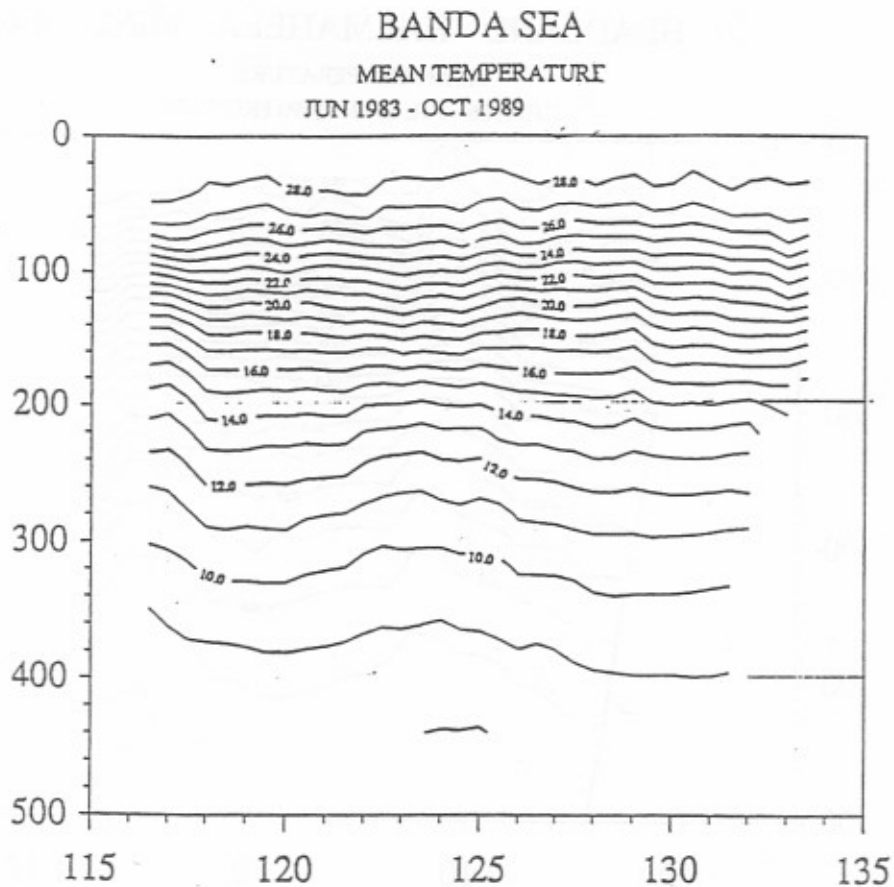
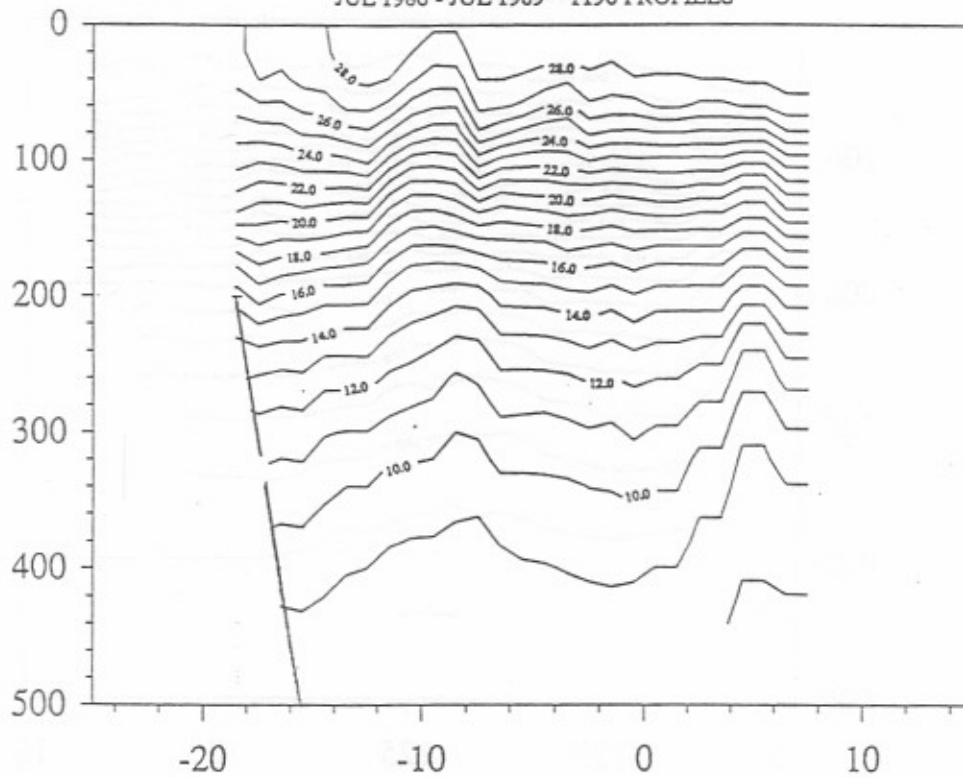

Figure 6B. As in Fig. 6A for the route from Djakarta to Torres Strait (Note that water depth is less than 100 m west of 116°E and east of 134°E).

## PT. HEADLAND - HALMAHERA - MINDANAO

MEAN TEMPERATURE  
 JUL 1986 - JUL 1989 1190 PROFILES



## SVERDRUPS

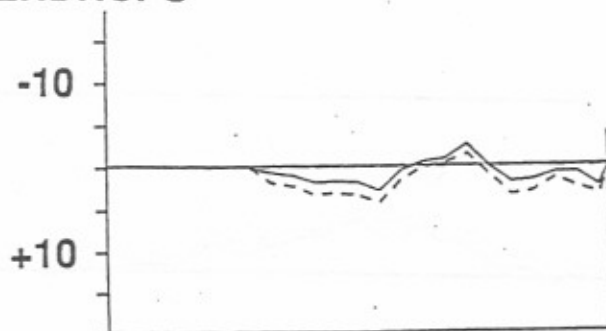

## RELATIVE TRANSPORT (0/400 DB)

Figure 6C. As in Fig. 6A for the route Port Hedland to Japan.

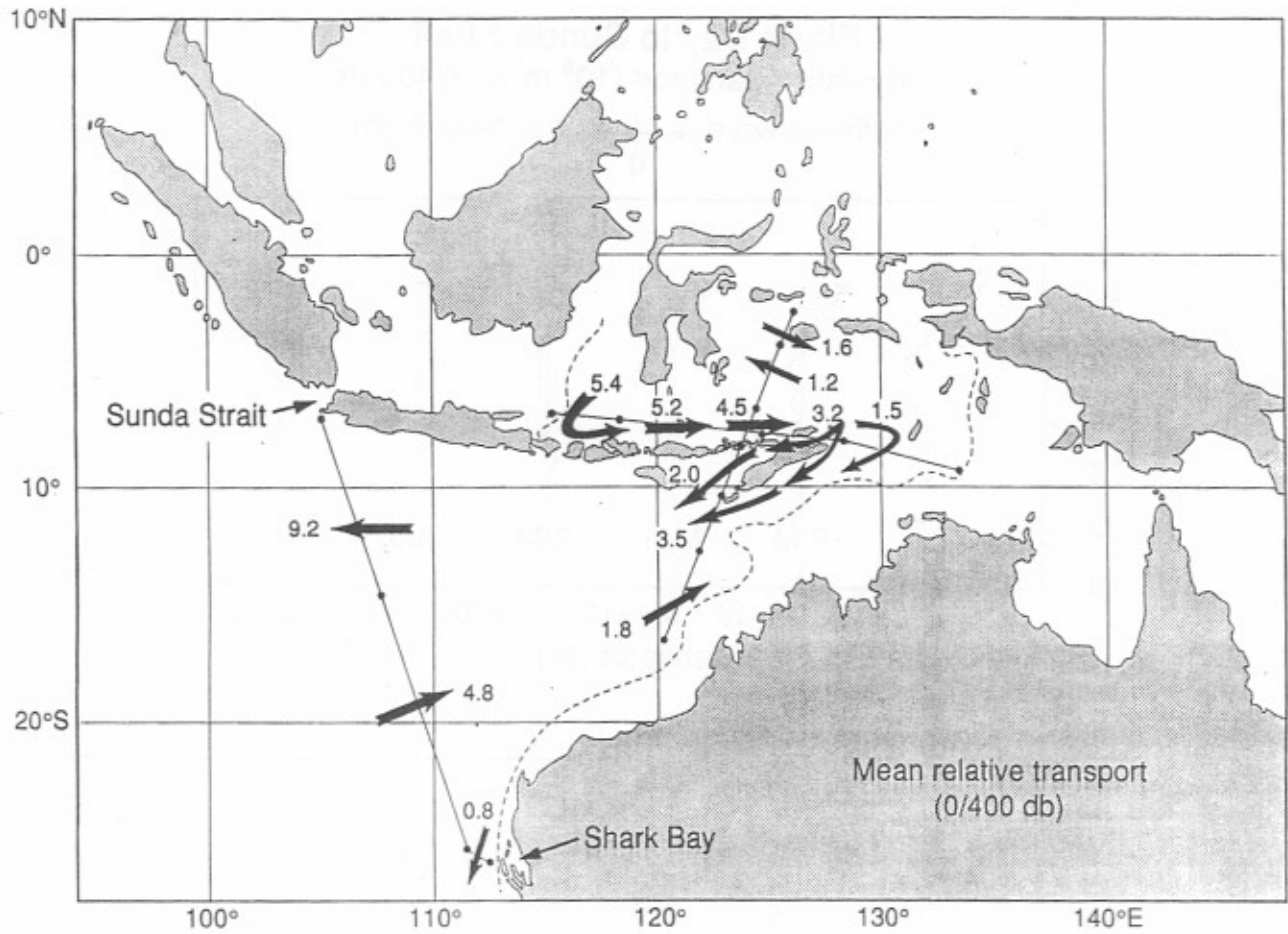

Figure 7. Long-term mean relative transport (0/400 db) in Sverdrups ( $10^6 \text{ m}^3/\text{s}$ ) estimated from the transport functions in Fig. 6. The boundaries of significant currents are marked by dots.

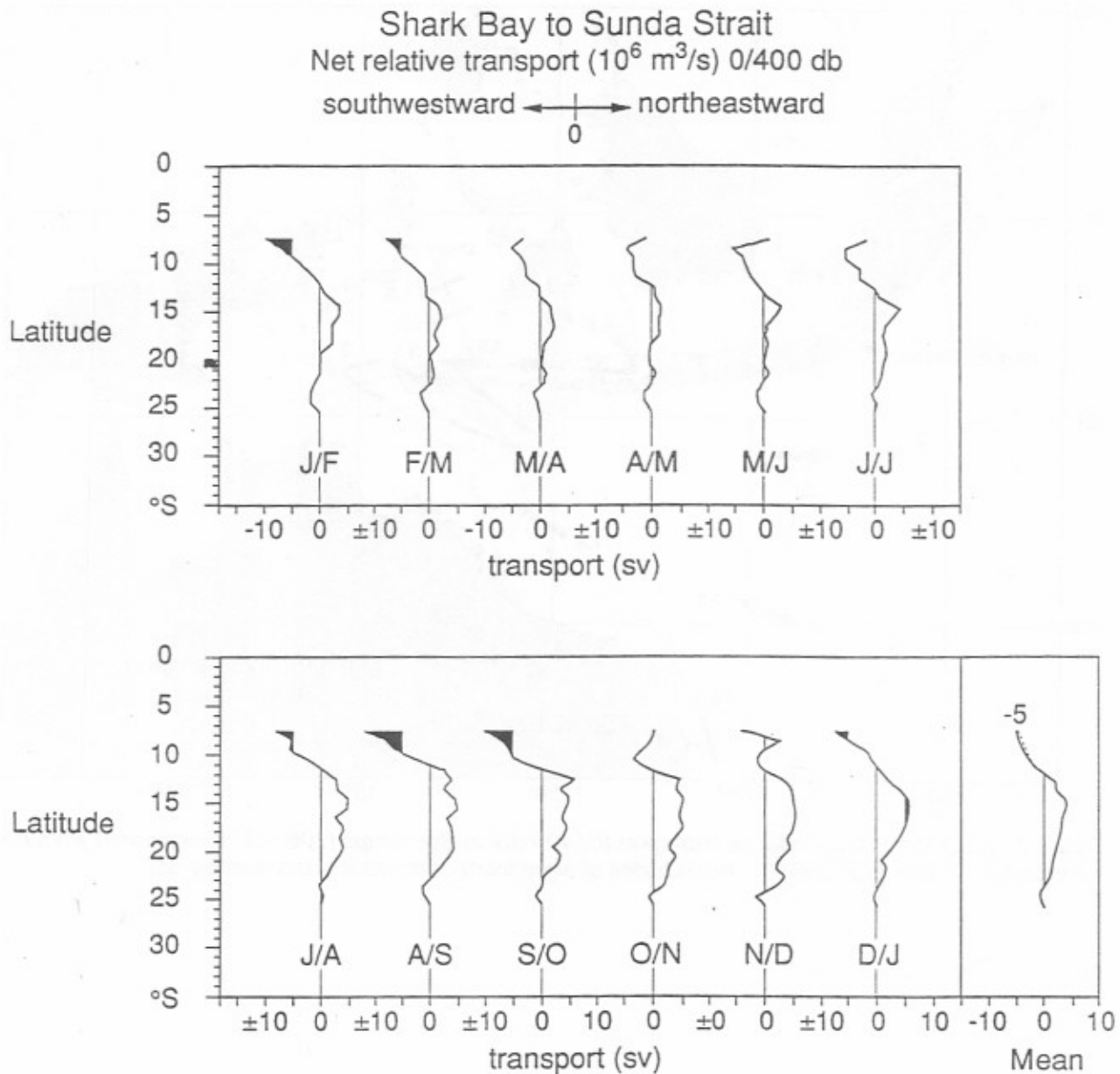

Figure 8. Annual variation of the net relative transport function on the section from Shark Bay to Sunda Strait.

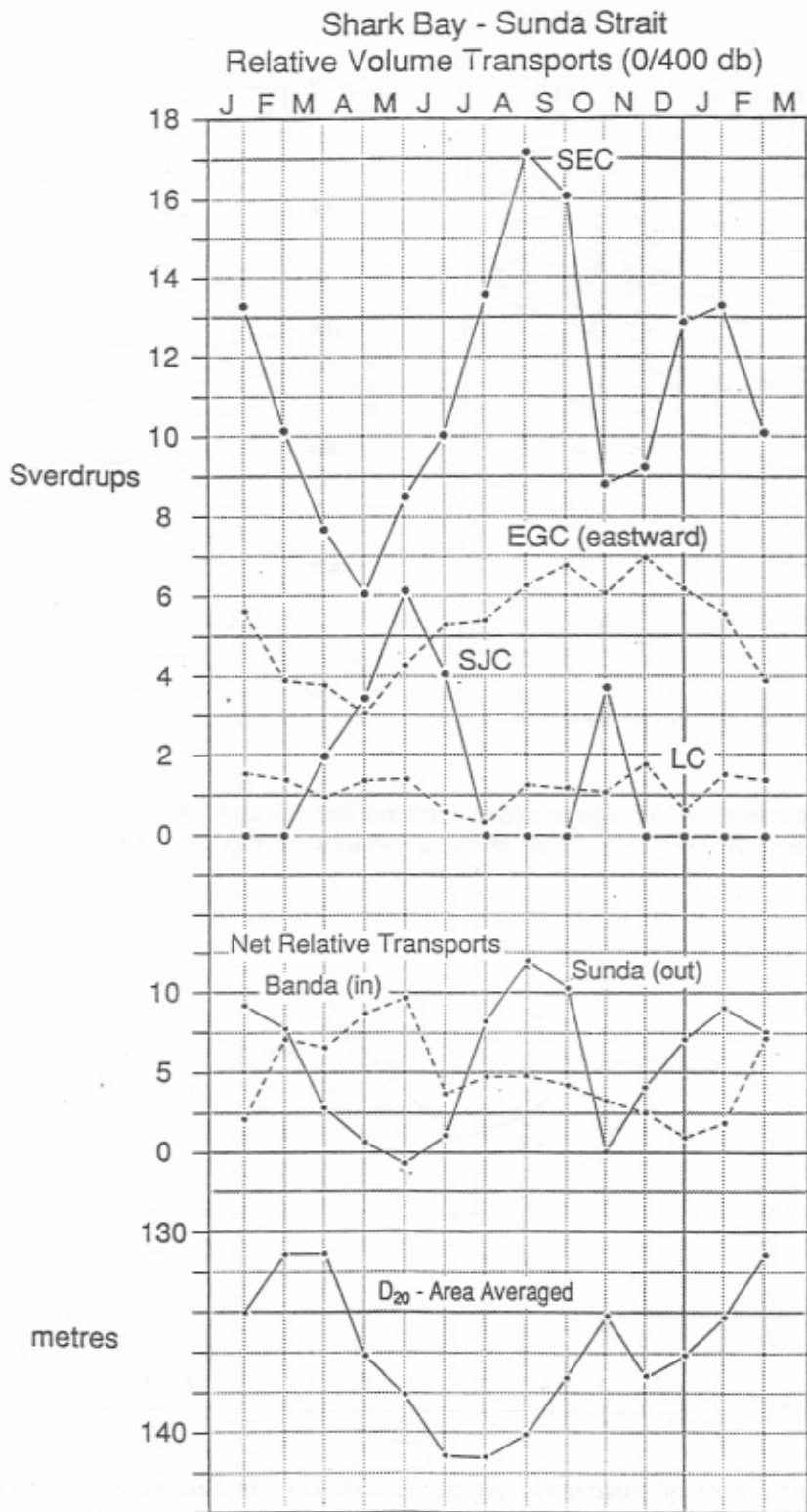

Figure 9. (Top) Annual variation of transport of major currents on the section from Shark Bay to Sunda Strait. South Equatorial Current (SEC); South Java Current (SJC); Eastward Gyre Current (EGC); Leuwin Current (LC). (MIDDLE) Net relative transport westward on the Shark Bay to Sunda Strait section (solid line labeled Sunda-out), and southward on the Djakarta to Torres Strait section (dashed line labeled Banda-in). (Bottom) Depth of the 20°C isotherm averaged by linear interpolation in the area between Java, Timor and northwest Australia.

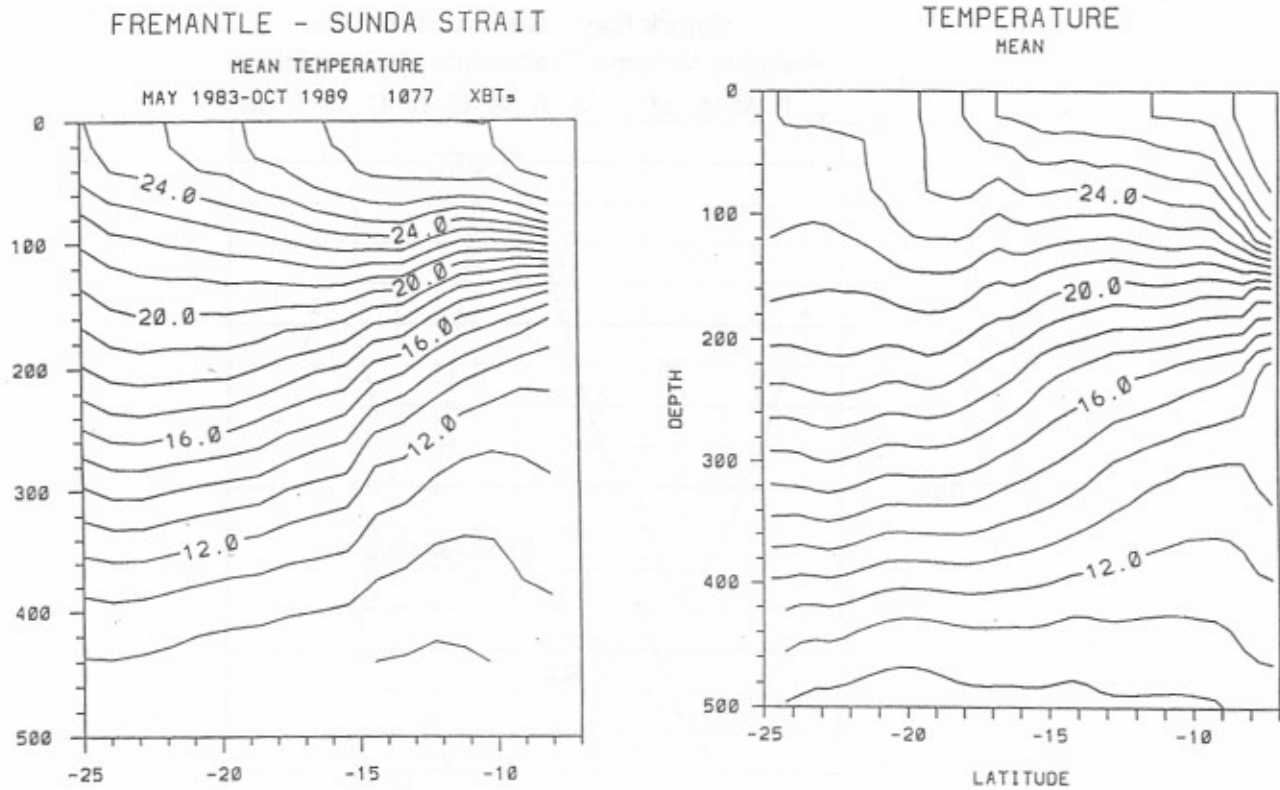

Figure 10. Comparison of the temperature sections from Shark Bay to Sunda Strait from the XBT observations (left) and from the ocean general circulation model (right) by Semtner and Chervin (1988).

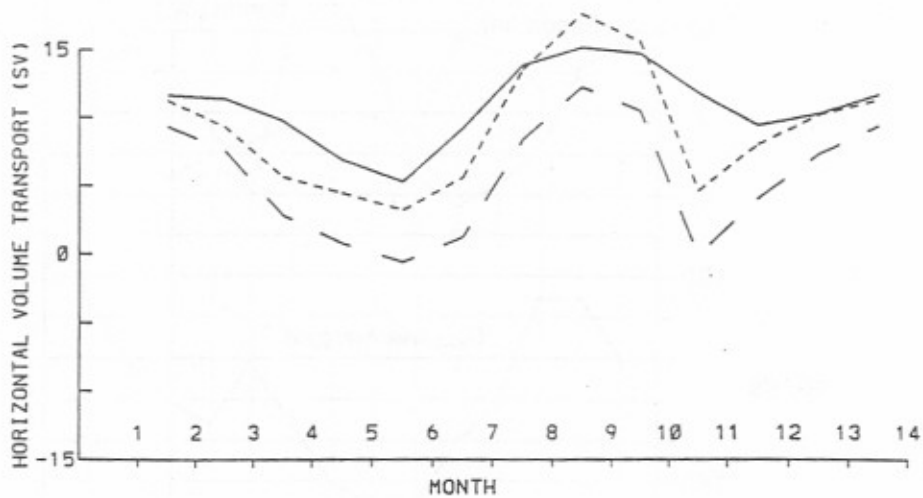

Figure 11. Comparison of transports on the Shark Bay to Sunda Strait section from the XBT observations (long dashed line) and the ocean general circulation model (solid line) by Semtner and Chervin (1988). The XBT transport plus the directly calculated Ekman transport is given by the short dashed line (from T. Qu, personal communication.)

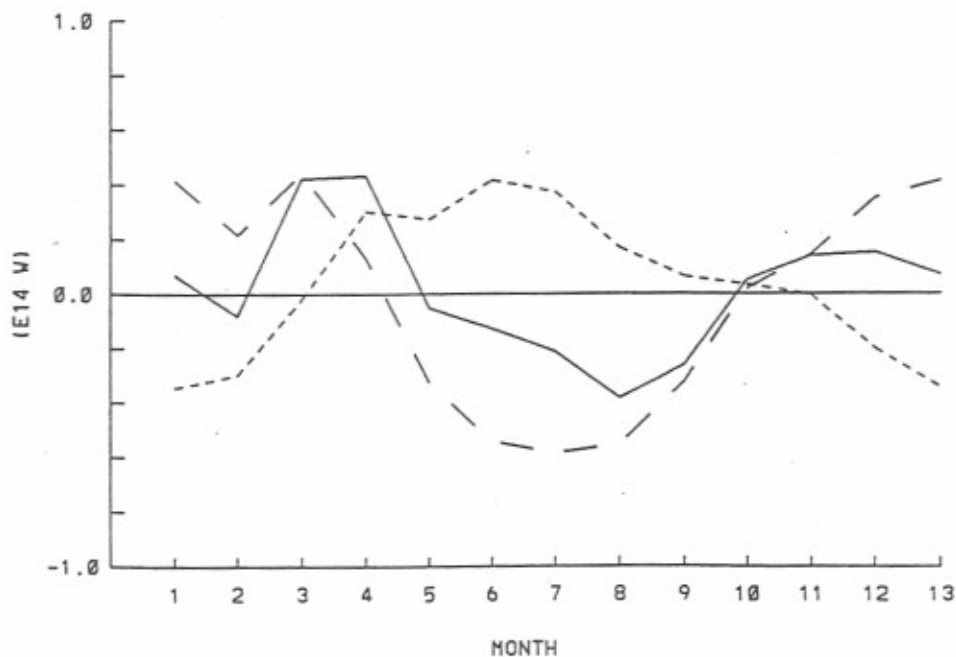

Figure 12. Surface layer (0-50 m) heat budget (in  $10^{14}$  W) over the area between northwest Australia,  $13^{\circ}$ S and the Shark Bay to Sunda Strait section. Surface heat flux (long dashed line); heat content change (solid line) and horizontal advection (short dashed line) (from T. Qu, personal communication).

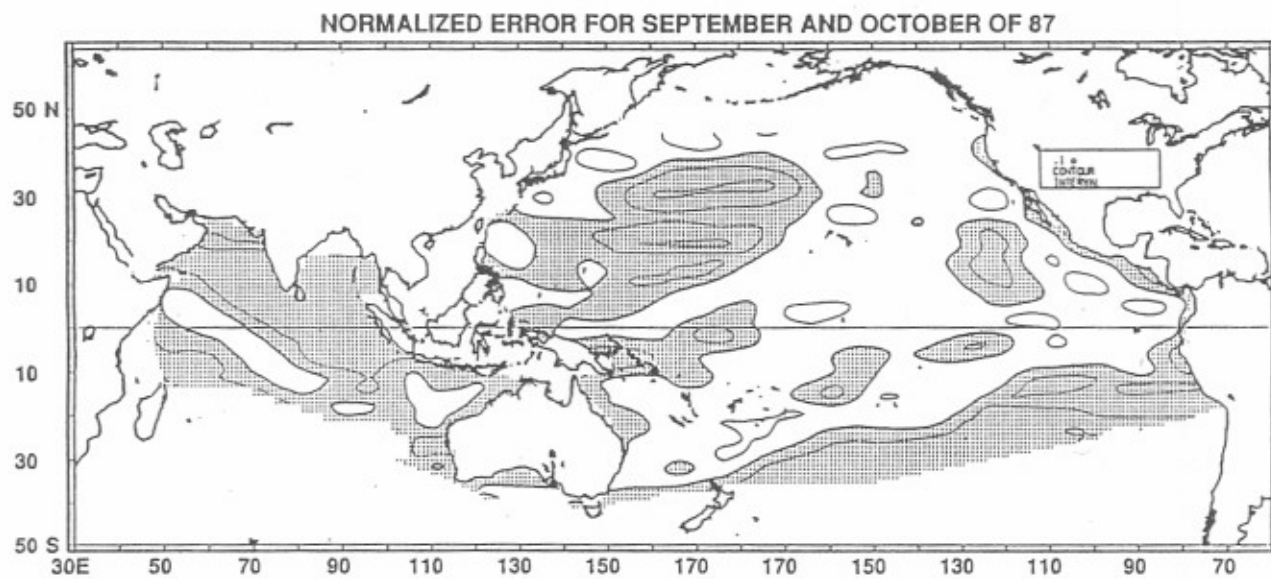

Figure 13. Normalized mapping error for the 400 m vertically averaged temperature anomaly, in standard deviations of the anomaly signal. Errors greater than 0.7 standard deviations are shaded. (from Pazan and White, 1991)



# Satellite Monitoring of the Global Ocean Surface During 1987-1989

---

*David Halpern*

## **Abstract**

Long-term simultaneous global coverage of AVHRR sea surface temperature, SSMI surface wind speed, GEOSAT sea surface height, and ARGOS buoy drift began in 1987. Methodology to create annual atlases of monthly mean distributions is described.

## **1 Introduction**

Progress in climate research depends on the availability of a variety of geophysical data sets to describe the boundary conditions and forcing functions of the climate system. The importance of long-period global data sets is highlighted in the U.S. National Aeronautics and Space Administration (NASA) Earth Observing System and the U.S. Committee on Earth and Environmental Sciences Global Change Research Program. The unique perspective from space provides the opportunity for observations well suited for the global ocean, which is an essential component of the climatic system and which remains severely undersampled.

Stommel and Fieux (1978), in their guide to oceanographic atlases, stated that "the oceanographic atlas is one of the main tools of the oceanographer". Because of the scarcity of oceanographic data, very few atlases cover the world ocean, and none provide monthly mean distributions for a particular year. Several years of monthly mean data are necessary to analyze the seasonal cycle and interannual variations.

Since about ten years ago, substantial advances in remote and in situ techniques to record temperature, sea level, horizontal current, and surface wind have helped define annual cycles and interannual variations. Innovative ideas of how the ocean and atmosphere are coupled together occurred in parallel with new instrumentation. Three examples are El Niño Southern Oscillation, the ocean-atmosphere flux of carbon, and the relationship between global sea surface temperature and precipitation over Africa.

Monthly mean distributions of geophysical variables, which cover the globe or a large-scale region like an ocean basin, are becoming de rigueur. Although both satellite- and ground-based recording systems provide essential information for global climate studies, satellite-borne instrumentation yields unprecedented spatial and temporal coverage of the global ocean. The production of a continuing

series of annual atlases was initiated in 1990 to meet the challenge of a visually attractive display of simultaneous monthly mean global oceanographic variables for education and research. Each atlas contains color displays of monthly mean distributions of satellite measurements for a 1-year interval. Satellite-derived surface wind speed, sea surface temperature, buoy drift, and sea surface height variation are described. Data limitations restricted the inclusion of all measurements in each atlas (Table 1). Each atlas also displays surface wind vector components, which were computed by a numerical forecast-analysis system.

## 2 Satellite-Derived Oceanographic Measurements

### 2.1 SSMI Wind Speed

The special sensor microwave imager (SSMI) is a 7-channel, 4-frequency, linearly polarized, passive microwave radiometer flown on the U.S. Air Force's Defense Meteorological Satellite Program (DMSP) F8 spacecraft in a circular sun-synchronous near-polar orbit at an altitude of approximately 860 km and an orbit period of 102.0 min. The orbit has an ascending (south-to-north) equatorial crossing at 0613 local time. The first SSMI of a series of ten was launched on 7 July 1987. The nearly 1400-km swath of SSMI produces complete coverage between 87°36'S to 87°36'N every 3 days. Each of the 7 separate passive radiometers measures naturally occurring microwave emissions from land, water and ice surfaces and from the intervening atmosphere. The SSMI receives both vertical and horizontal linearly polarized radiation at 19.3, 37.0 and 85.5 GHz and vertical only at 22.2 GHz.

The emitted microwave radiometer at the ocean surface is affected by roughness of the sea surface, which is correlated with the near-surface wind speed. Each atlas uses the Wentz (1989) surface wind speed data product. The Wentz (1989) algorithm relates wind speed at 19.5-m height ( $w$ ,  $m\ s^{-1}$ ) to the 37-GHz brightness temperatures, which are computed from the SSMI 37-GHz horizontal and vertical polarized radiance measurements, and to the radiative transfer and absorption between the sea surface and SSMI. The SSMI wind speed referenced to 10-m height is equal to 94.3% of  $w$  (Wentz, 1989).

The Wentz (1989) GDR contains wind speed values in nonoverlapping areas of 25 km x 25 km, which are arrayed across the 1394-km SSMI swath width. SSMI wind speeds within nonoverlapping 1/3° x 1/3° squares were arithmetically averaged to form the basic data set for each atlas. Most of the 1/3° x 1/3° areas contained at least 50 wind speed values per month. For each month, the standard deviation of daily-averaged SSMI surface wind speeds was computed for 1/3° x 1/3° areas containing 10 or more daily values per month.

The time series of the total number of 1/3° x 1/3° monthly-averaged SSMI wind speeds (Figure 1A) portrayed an annual cycle with a maximum in February-March when the ice cover around Antarctica is minimum. Each 1/3° x 1/3° SSMI

wind speed represented the arithmetic mean of several values. The total number of individual SSMI values was low in July 1987 and January 1988 (Figure 1B) because the instrument was not operated the entire months. The December 1987 data set ended on 4 December (Table 1) because of a 40-day off-period to avoid possible damage of the SSMI by increased heating of the bearing and power transfer assembly (Hollinger et al., 1990). During subsequent winters, the DMSP spacecraft solar arrays were repositioned so that the SSMI was not turned off.

The SSMI accuracy specification for wind speed retrievals under rain-free conditions is  $\pm 2 \text{ m s}^{-1}$  rms over the range 3-25  $\text{m s}^{-1}$ . Wentz (1991) compared SSMI wind speeds with a National Oceanic and Atmospheric Administration (NOAA) National Data Buoy Center moored buoy wind data set prepared by Goodberlet et al. (1990), and found differences of zero bias and 1.6  $\text{m s}^{-1}$  rms. Model functions different than Wentz' (1989) physically-based algorithm exist. The Environmental Research and Technology (ERT) algorithm for SSMI surface wind speed did not meet the accuracy specification (Goodberlet et al., 1990). Bates' (1991) statistical algorithm with brightness temperatures from five SSMI channels had a 1.1  $\text{m s}^{-1}$  bias and a 1.8  $\text{m s}^{-1}$  rms difference with moored buoy wind measurements at four sites from 5° to 5°N along 165°E. Halpern (in preparation) compared monthly mean Remote Sensing Systems-derived SSMI wind speeds and moored-buoy wind measurements at nearly 50 sites during 1988 and 1989: the root-mean-square (rms) difference was 1.2  $\text{m s}^{-1}$ ; and for SSMI monthly standard deviations of 1 - 2, 2 - 3, and 3 - 4  $\text{m s}^{-1}$ , the average absolute values of the monthly mean difference were 0.6, 0.9, and 1.4  $\text{m s}^{-1}$ , respectively.

## 2.2 GEOSAT Sea Surface Height

On 1 October 1986 the U.S. Navy's geodetic satellite (GEOSAT), which was launched on 12 March 1985, was maneuvered into an exact repeat orbit for oceanographic studies, which was named the Exact Repeat Mission (ERM). Each GEOSAT ERM orbit repeats within 1 km every 17.0505 days. The ground track separation at the equator is about 164 km. Global ERM data exists from 8 November 1986 until September 1989 when both tape recorders on GEOSAT ceased to operate; however, global data coverage was very poor after March 1989.

The technique is complex to convert a radar altimeter's travel time measurement between the satellite and the sea surface into a meaningful estimate of the elevation of the sea surface relative to a reference surface, which becomes the oceanographic signal of interest. The GEOSAT sea surface height data set used in the 1987- and 1988-atlases was based on the Zlotnicki et al. (1990) data product. Along each groundtrack, the environmentally corrected GEOSAT sea surface height relative to the reference ellipsoid,  $\text{SSH}_{\text{corrected}}$ , were resampled at fixed latitudes at about every 7 km using a cubic spline. No interpolation was made over a data gap larger than 3 s ( $\approx 21 \text{ km}$ ). During each ERM year, the groundtrack was repeated approximately 22 times. For each series of 22 repeats of the groundtracks, the repeated groundtrack with the most resampled  $\text{SSH}_{\text{corrected}}$  values was defined as a reference groundtrack.  $\text{SSH}_{\text{corrected}}$  differences or residuals, called  $\text{SSH}'$ ,

were computed between the reference groundtrack and all other groundtracks within the series. This deleted a 25 m rms uncertainty caused by the geoid (Zlotnicki, 1991). The orbit error was further reduced from 35 cm rms to less than 5 cm rms by fitting a once per revolution ( $\approx 101$  minutes) sine wave to resampled SSH'. The resampled, edited, environmentally corrected, GEOSAT residual sea surface heights are called SSH".

A 2-year (6 November 1986 - 5 November 1988) arithmetic mean SSH" value,  $\langle \text{SSH}'' \rangle$ , was computed at each location where 17 or more SSH" values existed. At sites where the 2-year mean SSH" value was not computed because of insufficient data, SSH" values were deleted from further data processing. Sea surface heights relative to the 2-year mean,  $\eta = \text{SSH}'' - \langle \text{SSH}'' \rangle$ , were then computed. All  $\eta$  values with positions within nonoverlapping  $1/3^\circ \times 1/3^\circ$  squares were arithmetically averaged in 30.5-day intervals to form the basic monthly data set. The total number of  $1/3^\circ \times 1/3^\circ$  monthly-averaged  $\eta$  values decreased slightly from January 1987 to December 1988 (Figure 2A). Each  $1/3^\circ \times 1/3^\circ$ - $\eta$  value represented the arithmetic mean of several  $\eta$  values. The total number of individual  $\eta$  values involved in the creation of each monthly averaged distribution decreased slightly from January 1987 to December 1988 (Figure 2B).

The accuracy of satellite altimeter estimates of sea surface height depends very much on the data processing procedures. Zlotnicki (personal communication, 1992) compared GEOSAT alongtrack data with the Wyrтки et al. (1988) tide gauge data from the Indian and Pacific Oceans. The  $\eta$  values were averaged over a 100-km groundtrack nearest to a tide gauge; this time series is called  $\eta_{100 \text{ km}}$ . The *in situ* 1-hour sampled sea level time series was low-passed filtered so that 50 and 95% of the amplitude squared were deleted at 2.5 and 1.7 days, respectively. Each low-passed filtered tide gauge time series was resampled at 17.05 days so that the times were coincident with the  $\eta_{100 \text{ km}}$  data set; the resampled *in situ* time series are called SL. Comparison of  $\eta_{100 \text{ km}}$  and SL time series at during 1987 - 1988 indicated an rms difference of 12.8 cm and the median correlation between the two time series was 0.43.

### 2.3 AVHRR/2 Sea Surface Temperature

The NOAA satellite platforms (called NOAA-j where j is an integer) are in sun-synchronous orbits at altitudes of 833 or 870 km with ascending equatorial crossings at 0730 or 1400 local time. Since the 1981 launch of NOAA-7, odd-numbered NOAA satellites have a five-channel advanced very high resolution radiometer called AVHRR/2. Even-numbered satellites have a four-channel advanced very high resolution radiometer called AVHRR. The AVHRR/2 scan rate is 360 swaths per min with a total field of view of  $\pm 55.4^\circ$  from nadir and with an effective ground resolution of 1.1 km at nadir in five coregistered bands. Two spectral channels are in the visible range (0.58 - 0.68 and 0.725 - 1.1  $\mu\text{m}$ ) and three in the infrared range (3.55 - 3.93 (i.e., 3.7)  $\mu\text{m}$ , 10.3 - 11.3 (i.e., 11)  $\mu\text{m}$ , 11.5 - 12.5 (i.e., 12)  $\mu\text{m}$ ). Infrared radiation received by a satellite radiometer is determined primarily by the sea surface emissivity and temperature and by atmo-

spheric transmittance. Atmospheric absorption of emitted radiation at the AVHRR/2 infrared wavelengths is primarily by water vapor, which occurs in the lower levels of the atmosphere. The transmission of emitted radiation through the atmosphere differs for each AVHRR/2 wavelength so that the difference of satellite-measured radiances at two or more wavelengths is independent of atmospheric absorber concentration. For small cumulative amounts of water vapor in the atmosphere, a linear combination of AVHRR/2 infrared radiation measurements recorded at the satellite yields an estimate of sea surface temperature, which is known as multi-channel sea surface temperature (MCSST). Radiance measurements from only cloud-free areas are processed by NOAA into MCSSTs. Very conservative cloud tests, which involve various combinations of the visible and infrared AVHRR/2 data, detect clouds so that cloud-free MCSSTs are computed (McClain et al., 1985); on a typical day, less than 2% of the maximum possible number of MCSSTs are retained.

The atlases contain day-time MCSST data produced operationally by NOAA's National Environmental Satellite and Data Information Service (NESDIS). The procedure is described by McClain et al. (1985). The 1.1-km AVHRR/2 observations are available only within areas containing a downlink ground station to receive high-resolution data transmission. Global AVHRR/2 measurements have an effective ground resolution of 4 km. A computer on board the NOAA spacecraft generates an average radiance for each channel from four 1.1-km elements within each nonoverlapping group of five consecutive 1.1-km measurements along a scan. The day-time MCSSTs archived on NESDIS global retrieval tapes represent the average sea surface temperatures within 8 km x 8 km areas, which would occur at 25-km intervals in a cloud-free environment. The 8-km x 8-km MCSSTs are mapped at the University of Miami's Rosenstiel School of Marine and Atmospheric Sciences (RSMAS) onto a cylindrical equi-rectangular grid of 2048 (longitude) x 1024 (latitude) space-elements (Olson et al., 1988). At the equator the dimension of each space-element is approximately 18 km x 18 km, and geographical coordinates are assigned to the center of the element. RSMAS produces MCSSTs averaged over 7 days. Four consecutive 7-day values are arithmetically averaged to form 28-day mean MCSST values. A 1024 x 512 grid was created by computing the arithmetic mean of four 18-km x 18-km MCSSTs adjacent to each other in a 2-dimensional array. The average MCSSTs of 4-element groups, which were independent of each other, represent an approximate  $1/3^\circ$  x  $1/3^\circ$  gridded MCSST data set.

The total number of  $1/3^\circ$  x  $1/3^\circ$  monthly-averaged MCSST values was smallest during June, July, and August, which coincided with intense cloud cover over huge oceanic areas of the middle latitudes of the southern hemisphere, and was highest during December, January, and February (Figure 3A). The range between maxima and minima was more than 25% of the annual mean.

The RSMAS MCSST data set contains the number of 8 km x 8 km values averaged to yield the 2048 x 1024 grid. The total number of 8 km x 8 km values

per month (Figure 3B) was low throughout most of 1987 and 1988 compared to that during 1989.

The coefficients used in the NOAA MCSST algorithm change only as the operational satellite is replaced and on rare occasions when the continuous validation procedure indicates a need for a change. NOAA continuously monitors the performance of the MCSST data product with satellite-tracked drifting buoy sea surface temperature measurements, which are recorded within 25 km and 4 h of the location of the MCSST. During 1987 - 1989, the MCSST was  $0.04^{\circ}\text{C}$  less than the in situ data and the rms difference was  $0.7^{\circ}\text{C}$  for an average of 388 matchups per month throughout the global ocean (Table 2).

#### **2.4 ARGOS Buoy Drift**

Since the late 1970s free-drifting buoys have been tracked throughout the world ocean by ARGOS, which is the French navigation system on NOAA polar orbiting satellites. ARGOS buoy drift data were not included in the atlases for 1987 and 1988 because the number of drifting buoys was considered insufficient for a global perspective. Canada's Marine Environmental Data Service (MEDS), which is a Responsible National Oceanographic Data Center (RNODC) for Drifting Buoy Data, continuously acquires ARGOS-tracked drifting-buoy positions transmitted in real time via the Global Telecommunications System (GTS).

ARGOS positions are determined with an accuracy of about 0.5 km. Approximately 5 ARGOS positions of drifting buoys were determined during a transmission day in 1989. ARGOS transmission days were not continuous. In the tropical Pacific Ocean a transmission day usually occurred at 3-day intervals and in the Southern Ocean the transmission was approximately daily.

A quality-control procedure was developed. The average monthly number of drifting buoys in the usable data set was 119. For each buoy in the usable data set, the monthly mean displacement vector was computed from the first and last recorded positions. Accordingly, the monthly mean buoy drift vector was equal to the displacement vector divided by the time interval between the first and last positions. Monthly mean east-west (positive eastward) and north-south (positive northward) components of buoy drift are displayed. A line of arbitrary thickness, which is color coded to represent the speed of the buoy drift, is drawn between the first and last positions of the month.

Large uncertainties are associated with interpretation of successive positions of a freely drifting buoy as a current vector at a specified depth. A variety of drifting buoys existed in the ocean during 1989 and there are fundamental differences between the behavior of each buoy in similar environmental conditions. The configuration of a drifter system greatly influences its drift (Niiler et al., 1987; Geyer, 1989; Brüggge and Dengg, 1991). The depth of the drogue, which is typically less than 25 m and as deep as 120 m (Thomson et al., 1990), influences the buoy drift (Bitterman and Hansen, 1989). The MEDS drifting buoy data set for 1989

indicated no drogues were attached to any buoys. However, some buoys, particularly in the tropical Pacific Ocean, contained a drogue at 15-m depth but information about the drogue depth was not transmitted on the GTS (D. Hansen, personal communication, 1992). Many drift buoys in the Southern Ocean had no drogue or contained a 100-m nylon line. Caution must be exercised in the interpretation of the 1989 buoy drift as near-surface current because of the unknown status and quality of the buoy and drogue.

## 2.5 Data Presentation

All data are presented in the annual atlases in the form of color-coded maps. To ease interpretation of features among different parameters, a common color code is used: blues represent low values, reds are high values, yellow and green are in the middle range, white means no data, and black represents land. Data are linearly scaled for color and an incremental color scale represents a contour interval. A single geographical scale is used for all maps. The land mask is the same throughout this report.

The color maps were generated on a Sun<sup>TM</sup>-4 computer using IDL<sup>®</sup>, which prepared the PostScript<sup>®</sup> files, and printed on a Tektronix<sup>TM</sup> Phaser CP Color Printer. All data values are retained in the PostScript<sup>®</sup> image files. The SSM/I images contain 1080 x 540 pixels (picture elements) and the AVHRR images contain 1024 x 512 pixels. All images are plotted on a 5.75-in. x 2.875-in. map. The PostScript<sup>®</sup> interpreter linearly transforms the size of each pixel within the user image file into a source-image coordinate system, which is compatible with the 300 dot-per-in. resolution of the Tektronix<sup>TM</sup>, to achieve the maximum rendition of the image.

## 3 Summary

Prediction of the intensity and timing of enhanced greenhouse warming caused by humankind's introduction of radiatively active gases into the atmosphere is heavily weighted with uncertainty. Improvement in prediction of the annual cycle and interannual variations of global variables is necessary to increase reliability of predictions of global warming. An impediment to global coupled ocean-atmosphere models is absence of global oceanographic data sets. The ability to make good use of satellite data is an important consideration.

The need for simultaneous global oceanographic observations has been often stated; perhaps Rennell, in 1822, made the earliest recorded statement (Pollard and Griffiths, 1991), which was followed by Maury (1885). The need for concurrent oceanographic observations remains as significant today as a century ago. Many studies of climate variations require knowledge of monthly mean global surface-oceanographic distributions with minimal amount of aliasing. The annual atlases displays observations from different satellites operated by different agencies. Very little averaging or interpolation of the data was made to retain the fundamental

sampling characteristics of each data set. Deficiencies of current remote sensing systems are easily seen in the atlas maps of data sampling density, which should be especially interesting to developers of new and innovative satellite-borne instrumentation.

### Acknowledgements

I am deeply indebted to Drs. Otis Brown (University of Miami), Frank Wentz (Remote Sensing Systems), and Victor Zlotnicki (JPL) for their tremendous help in creating the series of annual atlases. Dr. Paul McClain (NOAA) kindly sent me the monthly statistics of the MCSST matchups. The research described in this paper was performed by the Jet Propulsion Laboratory, California Institute of Technology, under contract with the National Aeronautics and Space Administration.

### References

- Bates, J.J. (1991) High frequency variability of SSMI- derived wind speed and moisture during an intraseasonal oscillation. *Journal of Geophysical Research*, 96, 3411- 3424.
- Bitterman, D.S., and D.V. Hansen (1989) Direct measurements of current shear in the tropical Pacific Ocean and its effect on drift buoy performance. *Journal of Atmospheric and Oceanic Technology*, 6, 274-279.
- Brügge, B., and J. Dengg (1991) Differences in drift behavior between drogued and undrogued satellite-tracked drifting buoys. *Journal of Geophysical Research*, 96, 7249-7263.
- Geyer, W.R. (1989) Field calibration of mixed-layer drifters. *Journal of Atmospheric and Oceanic Technology*, 6, 333-342.
- Goodberlet, M.A., C.T. Swift and J.C. Wilkerson (1990) Ocean surface wind speed measurements of the special sensor microwave imager (SSMI). *IEEE Transactions on Geoscience and Remote Sensing*, 28, 823-828.
- Halpern, D., V. Zlotnicki, J. Newman, O. Brown and F. Wentz (1991) An atlas of monthly mean distributions of GEOSAT sea surface height, SSMI surface wind speed, AVHRR/2 sea surface temperature, and ECMWF surface wind components during 1988. JPL Publication 91-8, Jet Propulsion Laboratory, Pasadena, 110 pp.
- Halpern, D., V. Zlotnicki, J. Newman, D. Dixon, O. Brown and F. Wentz (1992a) An atlas of monthly mean distributions of GEOSAT sea surface height, SSMI surface wind speed, AVHRR/2 sea surface temperature, and ECMWF surface



- wind components during 1987. JPL Publication 92-3, Jet Propulsion Laboratory, Pasadena, 111 pp.
- Halpern, D., W. Knauss, O. Brown and F. Wentz (1992b) An atlas of monthly mean distributions of GEOSAT sea surface height, SSMI surface wind speed, AVHRR/2 sea surface temperature, and ECMWF surface wind components during 1987. JPL Publication 92-3, Jet Propulsion Laboratory, Pasadena, 112 pp.
- Maury, M.F. (1885) *The Physical Geography of the Sea*. Harper and Brothers, 274 pp. McClain, E.P., W.G. Pichel and C.C. Walton (1985) Comparative performance of AVHRR-based multichannel sea surface temperatures. *Journal of Geophysical Research*, 90, 11587-11601.
- Niiler, P.P., R.E. Davis and H.J. White (1987) Water-following characteristics of a mixed layer drifter. *Deep-Sea Research*, 34, 1867-1881.
- Olson, D.B., G.P. Podesta, R.H. Evans and O.B. Brown (1988) Temporal variations in the separation of Brazil and Malvinas Currents. *Deep-Sea Research*, 35, 1971-1990.
- Paduan, J.D., and P.P. Niiler (1991) The WOCE/TOGA surface velocity program. ARGOS Newsletter, No. 42, 1-5. (Available from Service ARGOS Inc., Landover, MD 20785)
- Pollard, R. and G. Griffiths (1991) James Rennell: The father of oceanography. *Ocean Challenge*, 2 (2), 19- 21.
- Stommel, H., and M. Fieux (1978) *Oceanographic Atlases*. Woods Hole Press, Woods Hole, Massachusetts, 6 pp + 97 charts.
- Thomson, R.E., P.H. LeBlond, and W.J. Emery (1990) Analysis of deep-drogued satellite-tracked drifter measurements in the northeast Pacific. *Atmosphere-Ocean*, 28, 409-443.
- Wentz, F.J. (1989) User's manual: SSMI geophysical tapes. RSS Technical Report 060989, Remote Sensing Systems, Santa Rosa, California, 16 pp.
- Wentz, F. (1991) Measurement of oceanic wind vector using satellite microwave radiometers. Submitted to *Journal of Geophysical Research*.
- Wyrтки, K., P. Caldwell, K. Constantine, B.J. Kilonsky, G.T. Mitchum, B. Miyamoto, T. Murphy and S. Nakahara (1988) The Pacific island sea level network. JIMAR 88-137, University of Hawaii, Honolulu, 71 pp.
- Zlotnicki, V. (1991) Sea level differences across the Gulf Stream and Kuroshio Extension. *Journal of Physical Oceanography*, 21, 599-609.

Zlotnicki, V., A. Hayashi and L.-L. Fu (1990) The JPL- Oceans-8902 version of GEOSAT altimetry data. JPL Internal Document D-6939, Jet Propulsion Laboratory, Pasadena, 17 pp + 60 charts.

*Table 1. Duration of satellite-derived monthly mean measurements contained in annual atlases. Surface wind speed = S; sea surface height variation = SSH; sea surface temperature = SST; satellite-tracked drifting buoy = BUOY DRIFT. Detailed descriptions of the methodologies used to compute the satellite-derived measurements are given in the references.*

Data-Year	S	SSH	SST	Buoy Drift	Reference
1987	Jul-Nov	Jan-Dec	Jan-Dec		Halpern et al.
(1992a)	1988	Jan-Dec	Jan-Dec	Jan-Dec	Halpern et al.
(1991)	1989	Jan-Dec	Jan-Dec	Jan-Dec	Halpern et al.
(1992b)	1990	Jan-Dec	Jan-Dec	Jan-Dec	Halpern et al. (in preparation)
1991	Jan-Dec		Jan-Dec	Jan-Dec	Halpern et al. (in preparation)

*Table 2. Annual statistics of the global monthly mean bias and root-mean-square (RMS) difference between daytime MCSST and drifting-buoy SST (DRIBU SST) matchups. A matchup occurs when the MCSST was measured within 4 h and 25 km of a drifting-buoy SST. Bias = DRIBU SST - MCSST. (Monthly data courtesy of Dr. E. P. McClain, NOAA NESDIS)*

Year	Monthly Average Number of Matchups	Bias °C	RMS Difference °C
1987	234	-0.03	0.7
1988	245	-0.06	0.7
1989	384	-0.02	0.7

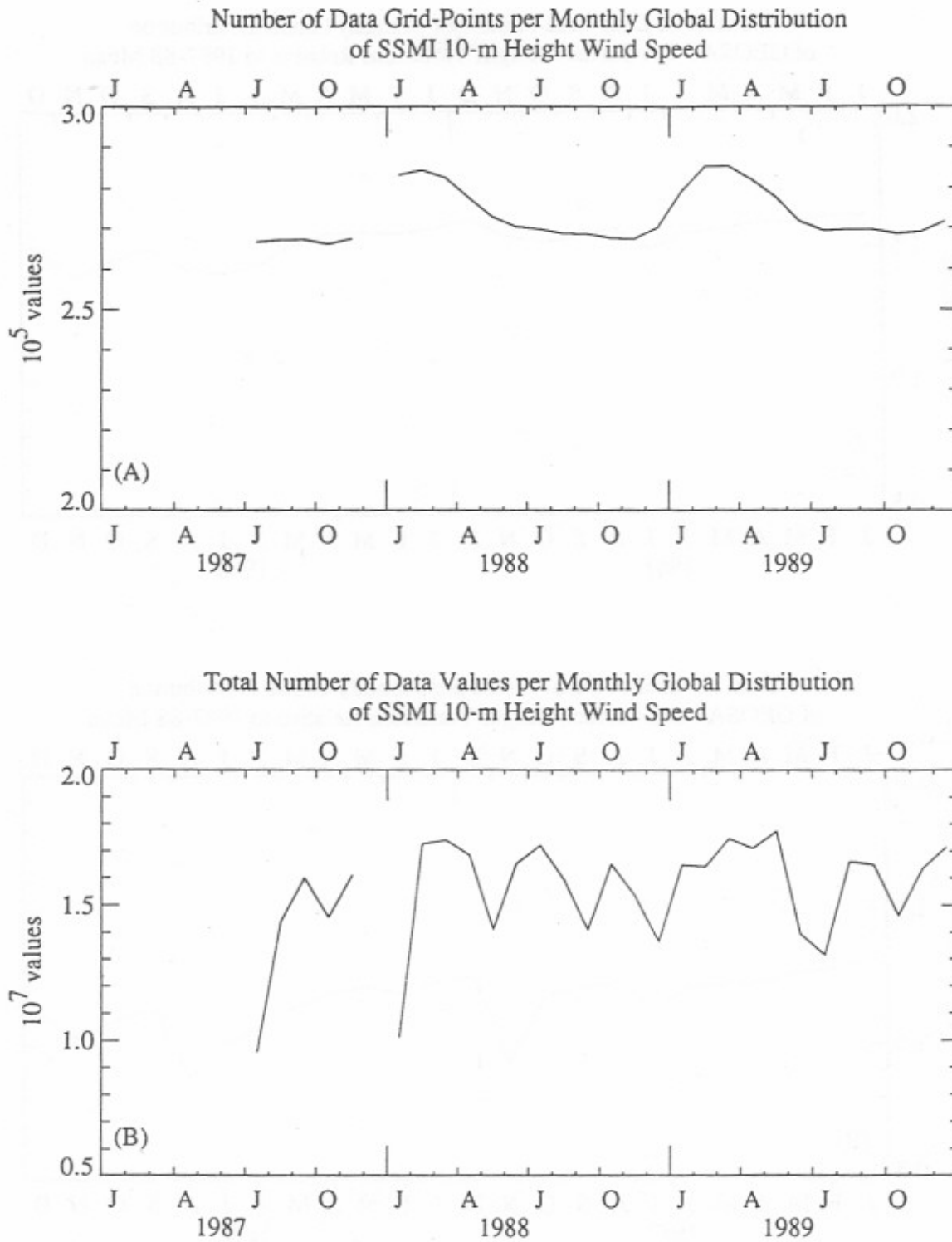

Figure 1. Time series of monthly totals of (A) number of  $1/3^\circ \times 1/3^\circ$  pixels or picture elements and (B) number of SSMI 10-m height wind speeds.

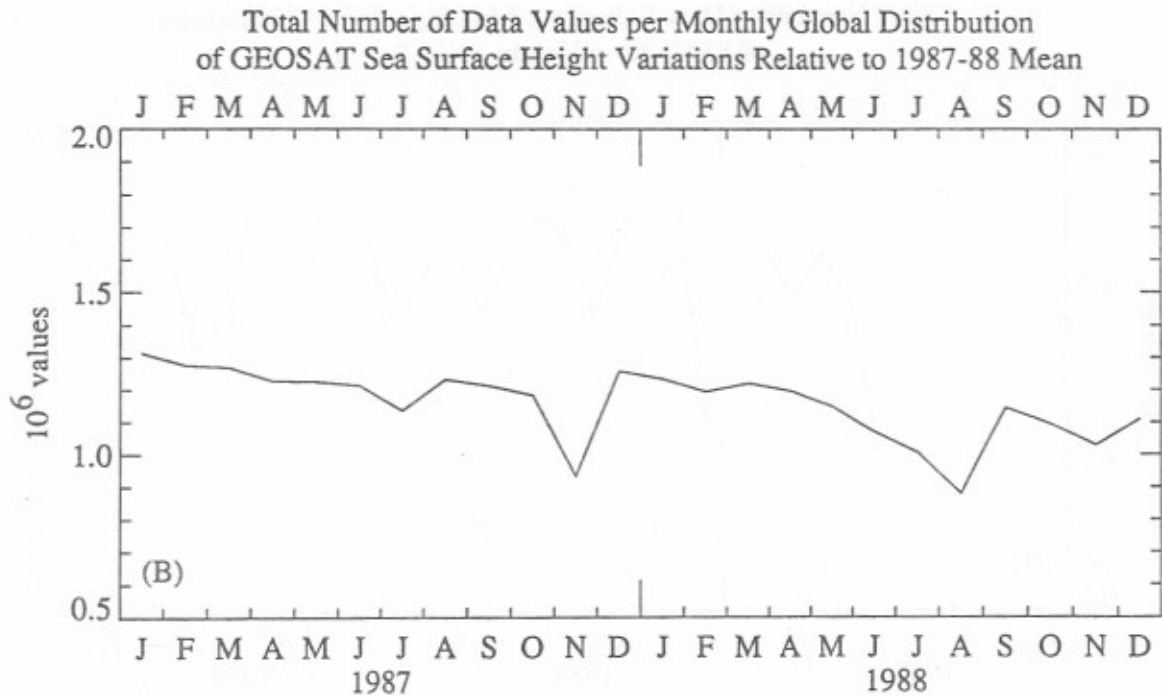
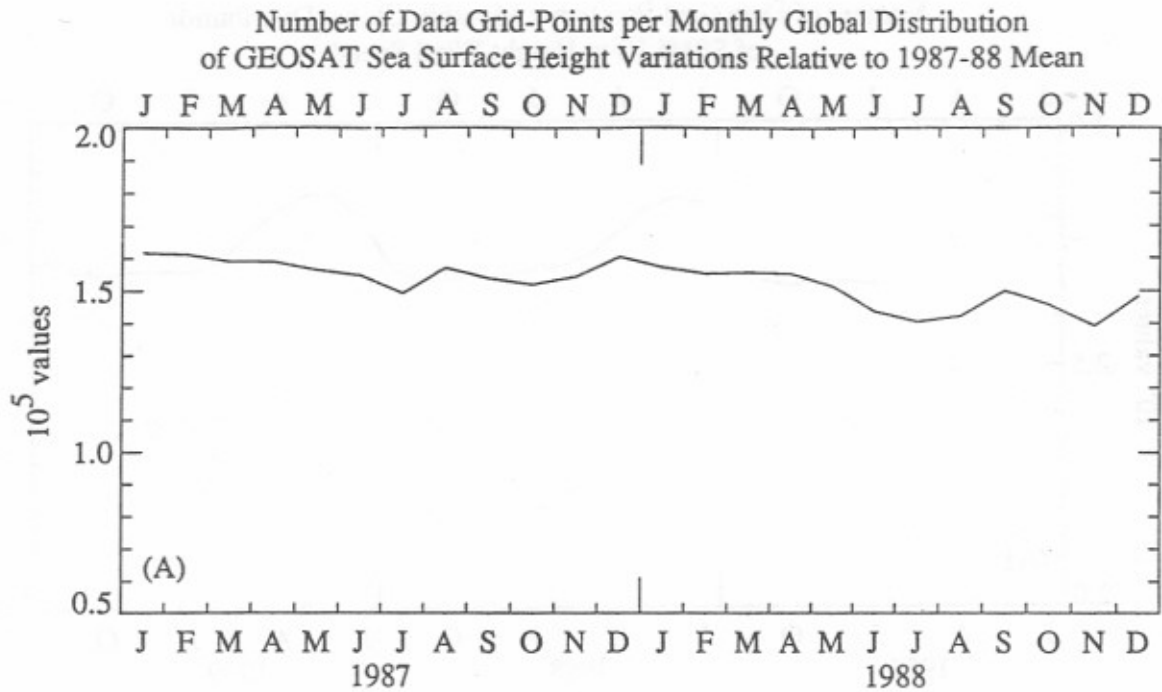

Figure 2. Time series of monthly totals of (A) number of  $1/3^\circ \times 1/3^\circ$  pixels or picture elements and (B) number of sea surface height variations relative to a 2-year mean.

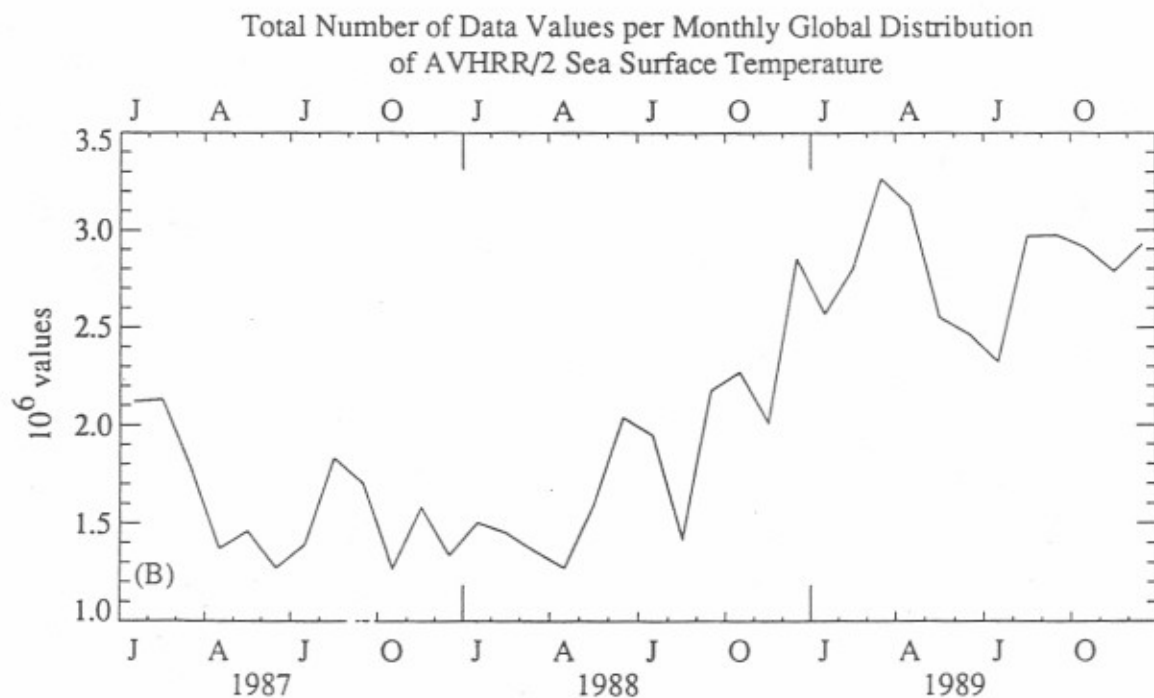
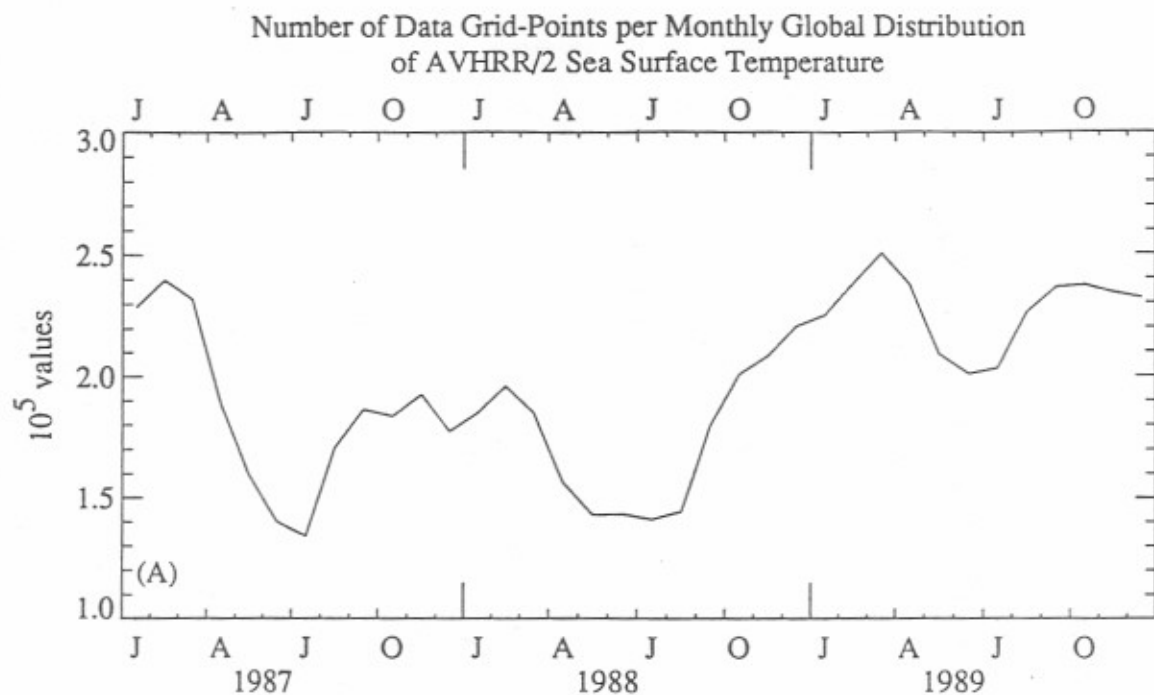

Figure 3. Time series of monthly totals of (A) number of  $1/3^\circ \times 1/3^\circ$  pixels or picture elements and (B) number of AVHRR/2 sea surface temperatures.

# The Use of Remotely Sensed Data for Operational Fisheries Oceanography

---

*Armando F.G. Fiúza*

## **Abstract**

Satellite remote sensing data are used under two contexts in fisheries: as a tool for fisheries research and as a means to provide operational support to fishing activities. Fishing operations need synoptic data provided timely; fisheries research needs that type of data and, also, good short-term climatologies.

A description is given of several experiences conducted around the world which have employed or are using satellite data for operational fisheries problems. An overview is included of the Portuguese program for fisheries support using remotely sensed data provided by satellites and in situ observations conducted by fishermen.

Environmental products useful for fisheries necessarily combine satellite and in situ data. The role of fishermen as a source of good, near- real-time in situ environmental data is stressed; so far, this role seems to have been largely overlooked.

## **1 Introduction**

Satellite observations of the sea, with their synopticity, repeatability, adequate resolution, and increasing availability, are particularly suitable for supporting fisheries. Satellite data are used in fisheries under two different but strongly interconnected contexts: as a tool for fisheries research, and as a means for providing operational support to fishing activities. Fisheries research aims at understanding the response of fish and marine mammals to their environment, at ensuring the maintenance of sustainable fish (and marine mammal) stocks while obtaining yields as high as possible, and at avoiding that harmful pollutants reach man through the marine food chain. On the other hand, the operational support to fishing activities aims at providing timely information to minimize search time and to direct fishing vessels to areas of optimal availability of desired species, based on knowledge of the marine environment and of fish behavior under different environmental conditions.

It seems that progress towards the quantitative understanding of the roles of biotic and abiotic factors and of their relative importance in fisheries oceanography has been slow. This is mainly due to a lack of multidisciplinary in the field. According to Leggett (1989), more specific reasons are: (i) the failure to integrate

basic knowledge of life history of target species with analyses of potential biotic and abiotic factors; (ii) the failure to fully integrate studies of physical and biological factors and their interactions; (iii) the failure to recognize the importance of temporal and spatial scales on the design of experiments and field surveys; (iv) the limitations imposed by sampling and analytical techniques available. The development of the use of satellite remote sensing of the ocean will surely contribute to overcome some of these problems.

Fiúza (1990) has recently reviewed the oceanographic, meteorological, chemical and biological parameters of interest for fisheries research and fishing operations, as well as the pertinent capabilities of satellite remote sensors, so these will not be repeated here. Amongst the advantages of satellite remote sensing over in situ methods are their large areal coverage, synopticity, long-term monitoring capability, lack of interference with the ocean processes under observation, and speed of availability, although the latter is unfortunately not always true. Satellite data also have some limitations, like being frequently limited to surface phenomena, their spatial and temporal resolution being somewhat limited and lacking flexibility, and their accuracy being often less than that attainable with in situ data.

Obviously, there is no antagonism between satellite and in situ data. As scientists and users become progressively more aware of the capabilities of satellite remote sensing, they increasingly take both methodologies as mutually complementary. This is true both in oceanography and fisheries and also in the context of the Earth climate system.

## 2 Scales

Satellite remote sensing provides space-time sampling rates adequate for many fisheries applications.

Typical time and horizontal length scales associated with phytoplankton are in the range 1 day-1 week and 1-10 km and, apart from solar radiation diel and seasonal cycles, relate with convergence-divergence mechanisms, stratification and turbulence ("frontal scales"). Zooplankton variability scales lie in the ranges weeks-months and 10-100 km, which are apparently related with mesoscale dynamical phenomena like semi-permanent fronts and long-lived eddies. The scales associated with fish aggregation (and marine mammals) are generally larger, ranging from months to years and from tens to thousands of km, and seem to be determined by large fronts, eddies and ocean current systems, as well as by their feeding habits.

The existing sensors of oceanographic interest onboard research or operational polar orbiters cover typically space-time scales from half-a-day or few days to years, and from 1 km or a few tens of km to several thousand km. The geostationary satellites have a coarser spatial resolution but sample enormous

regions in the tropics and subtropics every half-an-hour. These sampling characteristics of the satellites make them exceptional tools for measuring ocean parameters at scales compatible with those of fish, of zooplankton and even, to some extent, of phytoplankton.

In what concerns longer time scales of relevance for fisheries, like those related with interannual variability or short-term climate fluctuations (decadal time scales), it should be remarked that operational space platforms like the NOAA-X spacecraft and the geostationary meteorological satellites have already provided time series of consistent data (i.e., measurements with similar sensors) exceeding 10 years. These "historical" worldwide data sets deserve at least as much attention and analysis as the existing multi-year series of in situ observations at several points on the Earth's surface.

### **3 Examples of the use of satellite data in operational fisheries**

#### **3.1 Sea Surface Temperature, Ocean Color and Tunas**

Early studies using fish catch data and contemporary in situ measurements of sea surface temperature (SST) have led to good correlations between average catches and well defined temperature ranges, particularly for several tunas (e.g. Hela and Laevastu, 1970). This result has taken to an exaggerated belief on the importance of "preferred temperatures" on the aggregation of tunas, leading to such extrapolations as, for instance, to think that, given the "appropriate" isotherm, the "corresponding" tunas would follow it like a tramway on its rails ...

Tuna, like other living beings, obviously have preferential temperature ranges, and this has been justified in physiological grounds. However, those temperature ranges surely cannot determine by themselves the concentrations of tunas as they cover huge areas of the ocean at any given time and strong fish aggregations are commonly found outside those ranges. Studies where individual tunas were tracked acoustically for a few days have shown that they made frequent vertical excursions through strong vertical temperature gradients and spent most of the time in waters within or below the thermocline where temperatures were considerably below those believed to be within their "preferred" range (Laurs et al., 1984). Indeed, it appears that there is not such a thing as an "average" fish following a "mean" isotherm.

More recently, satellite-based studies on the tunas of the North Pacific, mainly concerning the albacore and the skipjack, have demonstrated that they concentrate near color (phytoplankton) fronts and that this aggregation is determined by the availability of food. This is revealed by the highest catches being near high phytoplankton values (derived from CZCS data), but not necessarily along thermal fronts, when these are not associated with color transitions (Laurs et al., 1984; Fiedler and Bernard, 1987). It thus appears that the combined use of satellite-



derived SST and color information, together with oceanographic and biological knowledge, should provide a good basis for an operational system for supporting tuna fisheries. This is exactly what was attempted during the existence of the CZCS, under the "NASA/JPL Satellite Data Distribution System and Demonstration Program to the US West Coast Fisheries". Under this program, satellite thermal (AVHRR) and color (CZCS) data were used in conjunction with more traditional marine and weather forecasts (mixed-layer depths, sea state conditions, wind speed and direction) for preparing near-real time support products for the albacore fishery, based on the scientific knowledge of the aggregation and feeding behavior of that tuna (Montgomery et al., 1986).

### **3.2 Ocean Color and the Menhaden Fishery**

Data from the Multi-Spectral Scanner (MSS) on the LANDSAT-1 (originally called ERTS-1) satellite were used 20 years ago by Kemmerer et al. (1974) in an experiment concerning the menhaden fishery off the Mississippi coast, in the Gulf of Mexico. This study was later extended to other areas of the Gulf of Mexico by Brucks et al. (1977).

Many in situ measurements were conducted under these investigations in connection with this pelagic fishery: ocean color (Forel), surface chlorophyll, water turbidity (Secchi disk), sea surface temperature and salinity. Menhaden concentrations correlated significantly with 0.6-0.7 m MSS channels radiances and with in situ observations of ocean color, chlorophyll content and turbidity; no correlation was found with sea surface temperature and salinity. These results were used to provide tactical support to that menhaden fishery based on LANDSAT/MSS data.

### **3.3 Fronts and the Butterfish Fishery**

Satellite-derived thermal (AVHRR) and color (CZCS) data were employed in combination with fish catch information and with in situ temperature profiles (XBT) in an investigation on the butterfish fishery in the northeastern Gulf of Mexico (Herron et al., 1989). The butterfish is a small demersal which is abundant in that region. Significant correlations were found between butterfish aggregation and SST distributions and SST gradients (in this case, with an exponential regression), color, turbidity, bottom topography, and the time evolution of oceanographic fronts. More specifically, large schools of butterfish were found to concentrate at or near fronts between warm, low-chlorophyll offshore waters and cooler, high-chlorophyll shelf and slope waters, mainly when these fronts were fully developed; when the fronts receded offshore and disappeared, the fish schools dispersed. Herron et al. (1989) indicate three mechanisms for the aggregation of butterfish near fronts: thermo-regulation, increased availability of food, and spawning selectivity.

This study on the butterfish fishery led to a satellite data-based (AVHRR) experiment designed to predict favorable fishing areas (Leming, 1990). Under this

experiment, an "expert system" installed on a personal computer (PC) used bottom depth, moon phase and satellite-derived SST gradients, SST, and location of eddies and fronts (relative to local bathymetric features), to derive the best areas for butterfly aggregation. The processed satellite imagery and fish location charts were then digitally transferred to PCs onboard fishing vessels at sea via the cellular telephone system that covers a large region of the northeastern Gulf of Mexico. The provision of digital data in near-real time to a computer freely operated by the fishing master gives him considerable flexibility and constitutes one of the ways ahead in the use of satellite-derived tools for supporting fishing operations.

### **3.4 The Japanese Fisheries Forecasting System (JFIC)**

JFIC constitutes, by far, the better organized and more comprehensive operational support system for fisheries. Some of its activities have recently been summarized by Yamanaka et al. (1988). Data collected from satellites (basically thermal data), fishing vessels, merchant and research ships, aircraft, and drifting or moored buoys, are gathered, processed and analyzed in near-real time by oceanographers and fishery scientists, who prepare and distribute marine environmental analysis and forecasts tailored for the needs of each fishery. These activities use extensively the existing (and continuously updated) knowledge on the structure and evolution of oceanographic features, particularly of fronts and eddies, as defined by their thermal signature on the surface of the ocean, and of their relationships with the aggregation of different species of fishes of commercial interest.

### **3.5 The Satellite-Based System for Supporting the Portuguese Fisheries**

Under the NATO-sponsored SATOCEAN Project, the University of Lisbon Group of Oceanography is conducting a research and applications program for supporting the fisheries in the Portuguese Exclusive Economic Zone, which includes large areas in the northeast Atlantic around the Azores and Madeira archipels and off Continental Portugal. These activities have recently been described by Santos and Fiúza (1992).

NOAA/HRPT data directly received, processed and archived at the SATOCEAN Space Oceanography Facility at the University of Lisbon constitute the backbone of the Project. This, apart from the activities for supporting fisheries, also includes investigations on the fine temperature structure of the upper ocean, on algorithms for the retrieval of SST from satellite infrared measurements, and on the spatial structure and time variability of SST in the northeast Atlantic.

The University of Lisbon is supporting operationally the Portuguese tuna and swordfish fisheries by providing them with near-real time products based on satellite measurements of sea surface temperature and on scientific knowledge of the oceanography of the NE Atlantic. These products include charts with the distribution of isotherms and with the location of thermal fronts and comments on

their evolution. Besides these operational activities, three research programmes are being carried out to investigate the relations between tuna, swordfish and sardine aggregations and simultaneous distributions of oceanographic parameters as derived from in-situ observations conducted by the fishermen and from satellite data. A preliminary finding of this research was that sardines concentrate in moderately cool, relatively "old" upwelling waters, on the inner shelf off western Continental Portugal. Another finding was that swordfish and tunas are preferentially found seaward of the semi-permanent thermal front separating coastal waters from the warmer open ocean off Continental Portugal. These activities will soon be considerably improved with the installation of computerized XBT systems with GPS positioning systems on board several sardine and swordfish fishing vessels and with the dissemination of WOCE-TOGA satellite-tracked drifting buoys with SST measuring capability in the NE-Atlantic.

#### **4 Conclusion**

Satellite data are of paramount importance for the operational support to fishing activities and to fisheries research. However, these data are still considerably under-used apparently because their importance is not yet widely understood. Also, the enormous potential of the fishing fleets as originators of good quality, intensive and systematic data from the sea has not been generally realized.

Another problem is that, in recent years, mainly since the demise of the CZCS, the only useful satellite-borne sensors for supporting fisheries whose data are adequately available have been basically the infra-red sensors on the NOAA-N and on the geostationary meteorological satellites, like METEOSAT and GOES. However, this situation will change considerably with the access to color data from the SeaWiFS, to be launched on the SeaStar in August 1993, with the increasing availability of passive microwave data mainly from the SSM/I sensors on the DSMP satellites, and with the radiometers and radars (scatterometer, SAR and altimeters) on the new generation of environmental satellites like the already flying ERS-1 and the soon to be launched TOPEX-Poseidon

The synergistic use of the data provided by these different but simultaneously observing systems, together with in situ observations made from automated platforms, merchant and fishing vessels, will allow the preparation of homogeneous data sets of relevant parameters like surface winds, ocean waves, ocean color, surface temperatures, currents, fronts and eddies. The combination of these observed fields with the fast increasing modelling capability of ocean processes, including physical-biological interactions, and their mutual integration with scientific understanding, will certainly lead to considerably increased meteorological/oceanographic/fishery analyses and forecasts which will provide better safety for operations at sea and improved support for fishing activities.

## Acknowledgements

This work was prepared under the SATOCEAN Project, which is sponsored by the NATO Science for Stability Programme. The presence of the author at the "Ocean Climate Data Workshop" was possible due to the financial support from the Commission of the European Communities (DG XII); this support is gratefully acknowledged.

## References

- Fiedler, P.C. and H.J. Bernard, 1987: "Tuna Aggregation and Feeding Near Fronts Observed in Satellite Imagery", *Continental Shelf Research*, 7(8): 871-881.
- Fiúza, A.F.G., 1990: "Application of Satellite Remote Sensing to Fisheries", p. 257-279 in "Operations Research and Management in Fishing", A. Guimarães Rodrigues (editor), Kluwer Academic Publishers.
- Hela, I. and T. Laevastu, 1970: "Fisheries Oceanography", Fishing News (Books) Ltd., London, 238 pp.
- Herron, R.C., T.D. Leming and J. Li, 1989: "Satellite-Detected Fronts and Butterfish Aggregation in the Northeastern Gulf of Mexico", *Continental Shelf Research*, 9(6): 569-588.
- Kemmerer, A.J., J.A. Benigno, G.B. Reese and F.C. Minkler, 1974: "Summary of Selected Early Results from the ERTS-1 Menhaden Experiment", *Fishery Bulletin*, 72(2): 375-389.
- Laur, R.M., P.C. Fiedler and D.R. Montgomery, 1984: "Albacore Tuna Catch Distributions Relative to Environmental Features Observed from Satellites", *Deep-Sea Research*, 31(9): 1085-1099.
- Leggett, W.C., 1989: "Toward a Scientific Basis for Fisheries Oceanographic Services", Abstract of a presentation to the "International Symposium on Operational Fisheries Oceanography (23-27 October, 1989, Newfoundland, Canada)".
- Leming, T.D., 1990: "Satellite Imagery Analysis/PC Data Link for Directed Butterfish Fishing, Final Report - Phase I", prepared for the Mississippi Department of Economic Development Contract no. 89-009-245, Southeast Fisheries Science Center, National Marine Fisheries Service, 63 pp. + Appendices.
- Montgomery, D.R., R.E. Wittenberg-Fay and R.W. Austin, 1986: "The Application of Satellite-Derived Ocean Color Products to Commercial Fishing Operations", *Marine Technological Society Journal*, 20(2): 72-86.

- Santos, A.M.P. and A.F.G. Fiúza, 1992: "Supporting the Portuguese Fisheries with Satellites", 6 pp., in "Proceedings of the European International Space Year Conference 1992 on Space in the Service of the Changing Earth (Munich, Germany, 30 March-4 April 1992)", in press.
- Yamanaka, I., S. Ito, K. Niwa, R. Tanake, Y. Yabuta and S. Chikuni, 1988: "The Fisheries Forecasting System in Japan for Coastal Pelagic Fish", FAO Fisheries Technical Paper no. 301, 72 pp.

## **OCEAN PC and a Distributed Network for Ocean Data**

---

*Douglas R. McLain*

### **Introduction**

The Intergovernmental Oceanographic Commission (IOC) wishes to develop an integrated software package for oceanographic data entry and access in developing countries. The software, called "OCEAN-PC", would run on low cost PC microcomputers and would encourage and standardize: 1) entry of local ocean observations, 2) quality control of the local data, 3) merging local data with historical data, 4) improved display and analysis of the merged data, and 5) international data exchange. OCEAN-PC will link existing MS-DOS oceanographic programs and data sets with table-driven format conversions. Since many ocean data sets are now being distributed on optical discs (Compact Discs - Read Only Memory, CD-ROM, Mass et al. 1987), OCEAN-PC will emphasize access to CD-ROMs.

OCEAN-PC would be modelled after WMO's successful Climate Computer (CLICOM) which has been installed in over one hundred locations to form an internationally distributed system for entry, display and exchange of meteorological data. OCEAN-PC would be installed in many locations globally to form a similar distributed system for oceanographic data.

An eventual goal of OCEAN-PC is to link with an electronic network of workstations and database management systems which is now being developed. This system is based on the Naval Environmental Operational Nowcasting System (NEONS) which is a fast, flexible data base management system designed for maximal use of computer and data exchange standards. NEONS database systems have been installed at several Navy and NOAA facilities and in Canada and Australia. The systems form a distributed network so that users can browse files on a local database or on a remote system over INTERNET to download data of interest. The network thus allows transparent, timely exchange of environmental data: each site does its own thing with its data and shares it in at high speed with others.

### **Development of OCEAN-PC**

IOC has proposed two avenues for the development of OCEAN-PC: 1) assemble and distribute a "shoebox" of floppy discs of available oceanographic programs and CD-ROMs of historical ocean data files, and 2) develop a plan to link the programs to form an integrated package entry, quality control, archive and display

of oceanographic data. The shoebox of programs will be available soon and this paper describes the present plan to integrate the programs. Shoebox programs include the ATLAST program for vertical oceanographic sections (Rhines 1991) and a program for satellite image analysis (Robinson et al. 1991).

Many problems exist that must be faced in linking available oceanographic programs and data sets. A major one is that we oceanographers use a multitude of data formats. Format conversions are often required to move data between programs. Each format conversion causes delays, possible data errors and losses, and software maintenance costs. Due to complexity of format conversions, international data exchange is inhibited as is merging of local data sets to form global data sets. Also because of the multitude of ocean data formats, available oceanographic programs are hard-coded to only a few specific formats and thus lack flexibility. Although a program may read and write data in several formats, once the program is compiled and distributed, it is limited to these formats.

An example is the GulfPlot program which is being developed by the Minerals Management Service in New Orleans and which is an initial component of OCEAN-PC (Brown 1992). GulfPlot was originally developed for mapping ocean data on a PC and exchange of data on electronic mail bulletin boards. GulfPlot is widely used in the Gulf of Mexico region with a many types of ocean data, including locations of ocean fronts and boundaries, tracks of drifting buoys, locations of oil spills, and strandings of marine mammals. Many of these data files are routinely posted on the OMNET GULF.MEX bulletin board. GulfPlot can now accept data from other sources, including the ATLAST program for vertical contour sections and ice edge data on the OMNET SEA.ICE bulletin board. Interfaces to other data sets, including ROSCOP data files and research ship tracks are being developed. The program can operate in any area globally and output data to commercial software (WordPerfect and SURFER).

Similarly, there is no standard format for CD-ROM data sets. An example of this is the CD-ROM of TOGA data for 1985-86 developed by the Jet Propulsion Laboratory (Halpern et al. 1990). This CD-ROM contains eleven different data sets and eleven different data extract programs. While there are ocean temperature and salinity profile data on the TOGA CD-ROM, the TOGA extract software can not read the two new CD-ROMs issued by NODC of several million profiles globally (NODC 1991). In general, it is not possible to read all CD-ROMs with a single set of software and thus users who wish to use data from several CD-ROMs are faced with an array of noncompatible programs.

Besides the data format problem, a second problem in designing OCEAN-PC is that of data sequence. For fast access to data, particularly from slow CD-ROM readers, all data required for a particular application must be available at the same time; PCs are too small for sorting large data files. For making: 1) contour oceanographic sections, the data should be sorted by ship and then time, 2) synoptic maps, the data should be sorted by time and the latitude or longitude, and 3) time series, the data should be sorted by area and then time. An example of

the importance of this is the difficulty of making oceanographic sections with ATLAST from data on the NODC CD-ROMs. The NODC CDs are sorted by Marsden Square and instrument type and thus much time is required to extract an oceanographic cruise.

### **Present Status of OCEAN-PC**

In summer 1992 under IOC funding, an initial version of OCEAN-PC will be developed by linking several programs and data sources: 1) The MMS GulfPlot mapping program, 2) A series of data entry, quality control and inventory programs developed by the International Council for Exploration of the Sea, and 3) The two NODC CD-ROMs of global temperature and salinity profiles.

The resulting program will be a minimal system to satisfy IOC's requirements. The program will be global in coverage and incorporate CD-ROM data files but will have only limited file maintenance facilities and be unable to handle additional data formats without additional hard-coded format conversions.

### **Future Expansions of OCEAN-PC**

If funding is available, OCEAN-PC will be expanded to avoid the problems associated with hard-coded software and to add flexibility. The development will be in three phases:

PC1: Use NGDC FREEFORM table-driven format conversion software for ASCII conversions and compact binary data storage,

PC2: Extend format converter software to read and write WMO BUFR and GRIB to store large oceanographic data sets on CD-ROMs and for international data exchange, and

PC3: Incorporate NEONS Database Management System.

#### **PC1: Table-Driven Conversions**

The National Geophysical Data Center (NGDC) has recognized the importance of the format problem for exchange and archive of geophysical data. To attack the problem, NGDC has developed a table-driven program, FREEFORM, to read and write data in fixed ASCII and binary (to the byte level) formats (Habermann and Mock 1991). Use of FREEFORM in OCEAN-PC will allow great flexibility in reading data sets and output to display programs. NGDC has already adapted FREEFORM to read the NODC CD-ROMs and is adapting it to read the ASCII data sets on the TOGA CD-ROM. OCEAN-PC will use FREEFORM to store data in binary for compact data storage and fast access.



NGDC designed FREEFORM to read CD-ROMs and other media for input to an advanced mapping program, GEO-VU, for global visualization of geophysical data. GEO-VU is an expansion of NGDC's very successful "Geophysics of North America" CD-ROM and software (NGDC 1989). GEO-VU is primarily for raster data but also can display point, line and gridded data sets. In OCEAN-PC, GEO-VU would replace GULFPLOT for greatly expanded mapping and display abilities and interface to many additional data sets, including geology, seismology, and global climate data. Also GEO-VU is programmed in C language with the "XVT" toolkit to allow operation on three graphics systems: Windows 3.0 on PCs, Apple Macintosh computers, and X-Windows on UNIX computers.

In OCEAN-PC FREEFORM will also be linked to a program being developed by Fleet Numerical Oceanography Center (FNOC) for downloading, contouring and display of weather and ocean gridded fields (Thormeyer et al. 1990). This program, NODDS PC, was developed as part of the Navy/NOAA Oceanographic Data Distribution System (NODDS) and is used in over 300 military locations for real-time access to FNOC analyses and forecasts. NODDS PC contours gridded fields, supports simple displays of satellite images, and plotting of weather and ocean observations. Users can overlay observations on fields and satellite images, grids on images, etc. The NODDS PC program will be supported for civilian users by the Ocean Applications Branch (OAB) of the National Ocean Service. In addition to real-time data and FNOC analyses and forecasts, OAB's system will store data for at least 30 days so that users can reconstruct marine events that led up to a particular event.

In support of OCEAN-PC, NOS/OAB will expand NODDS PC to use FREEFORM to access non real-time data sets on floppy discs or CD-ROMs. This will allow users to overlay real-time weather data from NODDS PC on historical data read with FREEFORM from CD-ROMs and other sources. In parallel with GEO-VU, OAB is supporting conversion of NODDS PC from MicroSoft QuickBASIC to C with the XVT windowing toolkit. NODDS PC and GEO-VU will thus become two display options in OCEAN-PC; NODDS PC for gridded meteorological and oceanographic fields and GEO-VU for raster and other geophysical data sets.

In cooperation with the NOS Ocean Observations Division, OAB will provide the NODDS PC software to merchant and other vessels to operate with OOD's SEAS (Shipboard Environmental data Acquisition System). NODDS PC and SEAS will use INMARSAT Standard C for two-way communications with fishing and other vessels: the vessels making subsurface XBT or mini-CTD profile casts and real-time SEAS reports and in return, receiving NODDS PC weather and ocean forecasts and analyses. Such a cooperative, two-way communications program will support the Global Ocean Observing System (GOOS) and help reduce the cost of XBT probes on merchant vessels for monitoring upper ocean thermal conditions.

### **PC2: Extend FREEFORM to BUFR and GRIB**

FREEFORM will be expanded to read and write data in the two binary formats being developed by WMO for improved real-time global exchange of weather and ocean observations on the Global Telecommunications System (GTS). These are the Binary Universal Format for data Representation (BUFR) for observations and GRidded Binary for gridded fields (Stackpole 1990). BUFR is a table-driven format and is sufficiently flexible for use with many types of environmental observations. Use of BUFR and GRIB in OCEAN-PC will allow: 1) compatibility with the GTS and 2) compactness for efficient storage and fast retrieval on relatively slow CD-ROM readers. While BUFR has not been widely used in oceanography (only in the IGOSS/IODE GTSP program), GRIB is commonly used in meteorology and for some CD-ROM data (e.g. ECMWF weather fields on the TOGA CD-ROM).

To handle BUFR and GRIB, the FREEFORM software will be extended to read and write data down to the bit level. Also, the format descriptor tables in FREEFORM will be linked to WMO's data descriptor tables for BUFR and GRIB which will require standardization of names and units of environmental variables. Many oceanographic variables have already been defined by the IODE General Format 3.

Incorporation of BUFR and GRIB formats in OCEAN-PC will allow compatibility with an evolving internationally distributed network of database management systems as described later. Experiments will be made to store large data sets in BUFR and GRIB on CD-ROMs. This work would be in close cooperation with NODC who can prepare and publish CD-ROMs. For fast access to data from relatively slow CD-ROM readers, experiments will be made to determine optimum sort sequences for specific applications.

### **PC3: Incorporate NEONS Database Management System**

The file structure of the OCEAN-PC must be designed for flexible, fast extracts and retrievals. Initial versions of OCEAN-PC will use BASIC random access files and binary files generated by FREEFORM. Later versions of OCEAN-PC will test data storage in BUFR and GRIB formats. These file structures are simple and convenient but lack the flexibility of a database management system. A modern database system is the NEONS database management system which has been installed on a desktop UNIX microcomputer. Incorporation of NEONS in an advanced version of OCEAN-PC would allow linkage with an evolving international network of database systems for fast, timely international data exchange.

### **Distributed Network of Database Systems**

The Naval Environmental Operational Nowcasting System (NEONS, Shaw et al. 1990, Jurkevics et al. 1990) was developed by the Naval Research Laboratory (NRL) in Monterey, CA. NEONS is based on the commercial database management system and was designed for maximal use of standards, including UNIX, X-

Windows, INTERNET communications, and the WMO BUFR and GRIB data formats. NEONS was designed to take advantage of fast new RISC processors and is compute bound whereas many other database systems are input/output bound.

NEON systems are installed at several Navy sites and also in Canada and Australia. The Navy offered the NEONS software to NOAA at no cost and NOS/OAB has supported its use within NOAA. To date NEON systems have been installed at NOS/OAB, the National Climate Data Center (NCDC) in Asheville, NC, and the Climate Monitoring and Diagnostics Laboratory (CMDL) in Boulder, CO. Several additional NOAA installations are proposed. The NEONS at NOS/OAB serves as a file server for distributing FNOC weather and ocean data to users with NODDS PC software.

NRL is developing browse software which will be the user's window into the NEONS network. Using this software, the user graphically specifies for what area of the world and what time period he desires data and then the software queries the database (either locally or remotely over INTERNET) so he can progressively refine his request to data types and data sets of interest. The browse software will use FREEFORM to format the downloaded data as specified by the user and in the future, display the QC characteristics of the downloaded data.

The several NEON systems form the basis for an internationally distributed network of database management systems where each system can browse files on other systems and download data sets of interest. For example in the Global Climate Perspectives System, NCDC in Asheville is loading global temperature and precipitation and other data into their NEONS. The Climate Analysis Center in Washington DC has accessed NCDC's database over INTERNET, browsed files and downloaded data. Meanwhile CMDL in Boulder is loading surface marine weather data (COADS) and other data into their NEONS for local and remote access.

NEONS incorporates software to convert data to UNIDATA's NetCDF format for use by display and analysis programs and for international exchange. Software to also convert data to NASA's Common Data Format (CDF) and to the University of Illinois Supercomputing Center's Hierarchical Data Format (HDF) will be developed.

## References

- Brown, M.L. 1992. GULPLOT: Oceanographic Charting Software for the World's Seas, Version 4.0. U.S. Department of the Interior, Minerals Management Service, Gulf of Mexico Regional Office, New Orleans, LA.
- Habermann, R.E. and D. R. Mock. 1991. Common Data Formats: Common Data Problems? Eighth International Conference on Interactive Information and Processing Systems for Meteorology, Oceanography, and Hydrology. American Meteorological Society, 79-81.

- Halpern, D., Ashby, H., Finch, C., Smith, E. and Robles, J. 1990. TOGA CD-ROM Description. NASA Jet Propulsion Laboratory. Pasadena, CA. JPL Publication 90-43, 43 pp.
- Jurkevics, A., R. Titus, and J. Clark. 1990. Environmental Database for the Naval Environmental Operational Nowcasting System. Sixth International Conference on Interactive Information and Processing Systems for Meteorology, Oceanography, and Hydrology. American Meteorological Society. Anaheim, CA. February 5-9, 1990, 80-83.
- Mass, C.F., H.J. Edmon, H.J. Friedman, N.R. Cheney, and E.E. Recker. 1987. The Use of Compact Discs for the Storage of Large Meteorological and Oceanographic Data Sets. *Bull. Amer. Meteor. Soc.* 68:12, 1556-1558.
- National Geophysical Data Center. 1989. Geophysics of North America CD-ROM. Boulder, CO.
- NODC, 1991. CD-ROMs NODC-02 and NODC-03: Global Ocean Temperature and Salinity Profiles. National Oceanographic Data Center, Washington, DC. July 1991, 14 pp.
- Rhines, P.B. 1991. ATLAST, A World-Ocean Atlas of Hydrography, Nutrients and Chemical Tracers. University of Washington, School of Oceanography. Technical Report 91-1. Release 3.0 vi 91. 37 pp. (Report and floppy disc available from Ms. Ruby Lassanyi, Jet Propulsion Laboratory, User Support Office, MS 300-320, 4800 Oak Grove Drive, Pasadena, CA.)
- Robinson, I., R. Callison, D. Blackburn, S. Boxall, C. Garcia, J. Monaghan, R. Nunes Vax, S. Sathyendranath, and D. Troost. 1991. Applications of Marine Image Data. Marine Sciences Training and Education Programme, MARINF/81. UNESCO. Paris, France, 85 pp.
- Shaw, C., E. Schwartz, and T. Tsui. 1990. Design of the Naval Environmental Operational Nowcasting System. Sixth International Conference on Interactive Information and Processing Systems for Meteorology, Oceanography, and Hydrology. American Meteorological Society. Anaheim, CA. February 5-9, 1990, 233-236.
- Stackpole, J.D. 1990. GRIB and BUFR: The Only Codes You Will Ever Need. Sixth International Conference on Interactive Information and Processing Systems for Meteorology, Oceanography, and Hydrology. American Meteorological Society. Anaheim, CA. February 5-9, 1990, 23-30.
- Thormeyer, C.D., J.P.A. Putzig, J.P. Garthner, and A.J. Klapp. 1990. The Navy Oceanographic Data Distribution System (NODDS) - An Upgrade. Sixth International Conference on Interactive Information and Processing Systems for

**Meteorology, Oceanography, and Hydrology. American Meteorological Society. Anaheim, CA. February 5-9, 1990, 129-132.**

## Sea Level Variation

---

*Bruce C. Douglas*

### Summary

Published values for the long-term, global mean sea level rise determined from tide gauge records range from about one to three mm per year. The scatter of the estimates appears to arise largely from the use of data from gauges located at convergent tectonic plate boundaries where changes of land elevation give fictitious sea level trends, and the effects of large interdecadal and longer sea level variations on short (<50+ years) or gappy records. In addition, virtually all gauges undergo subsidence or uplift due to isostatic rebound from the last deglaciation at a rate comparable to or greater than the secular rise of sea level. Modeling rebound by the ICE-3G model of Tushingham and Peltier (1990) and avoiding tide gauge records in areas of converging tectonic plates produces a highly consistent set of long sea level records. A global set of 21 such stations in nine oceanic regions with an average record length of 76 years during the period 1880-1980 yields the global sea level rise value 1.8 mm/year  $\pm$  0.1.

Greenhouse warming scenarios commonly forecast an additional acceleration of global sea level in the next 5 or 6+ decades in the range 0.1-0.2 mm/yr<sup>2</sup>. Because of the large power at low frequencies in the sea level spectrum, very long tide gauge records (75 years minimum) have been examined for past apparent sea level acceleration. For the 80-year period 1905-1985, 23 essentially complete tide gauge records in 10 geographic groups are available for analysis. These yielded the apparent global acceleration -0.011 ( $\pm$  0.012) mm/yr<sup>2</sup>. A larger, less uniform set of 37 records in the same 10 groups with 92 years average length covering the 141 years from 1850-1991 gave 0.001 ( $\pm$  0.008) mm/yr<sup>2</sup>. Thus there is no evidence for an apparent acceleration in the past 100+ years that is significant either statistically, or in comparison to values associated with global warming. Unfortunately, the large interdecadal fluctuations of sea level severely affect estimates of global sea level acceleration for time spans of less than about 50 years. This means that tide gauges alone cannot serve as a reliable leading indicator of climate change in less than many decades. This time required can be significantly reduced if the interdecadal fluctuations of sea level can be understood in terms of their forcing mechanisms, and then removed from the tide gauge records.

# **Data Archaeology**

---

*Convener - Sydney Levitus*

## Data Archaeology

---

Speakers throughout the entire Workshop stressed the importance of historical data in understanding the oceans effect on climate changes and climate change effects on the ocean. This session concentrated on the availability of historical data, the need for additional data, the manipulation of these data into reliable coherent values suitable for modeling and product development, and the problems associated with the collection and dissemination of these data to users.

Unfortunately, some of the papers presented in oral form are not available for these proceedings. An abstract provided by the speaker is given here when available. Otherwise, a summary has been prepared and most speakers have reviewed these statements.

In addition to the speakers listed in the program, Dr. Bruce Douglas (currently Director of the U.S. NODC) delivered a paper on historical sea level data. His talk along with the paper on satellite altimetry added the importance of sea level to our understanding of climate change to others who spoke of physical and chemical properties of sea water. Again, the uses of these data for modeling was presented. Papers by Sychev and Dooley, as well as remarks by Levitus led to interesting discussions on the quantity (and quality) of data stored in laboratories and research facilities. There was some speculation that the national and world oceanographic data centers may have less than 50% of the physical/chemical data that has been collected. Finally, Professor Ojo presented the view of the user in developing countries emphasizing the difficulties in obtaining access to data and to having the technological tools ( and training) to properly utilize these data.

Issues and recommendations brought out in these papers and in subsequent discussions are reflected in the "Wrap-up" session of these Proceedings. These discussions emphasized the need for an international data archeology project.



## Ocean Climate Diagnostic Studies

---

*Sydney Levitus*

### Notes

The following notes were provided by Dr. Levitus:

- A. Why do scientists need digital access to a complete set of historical oceanographic data?
  - 1. To determine the role of the ocean as part of the earth's climate system.
    - a. To be able to perform pure diagnostic studies of the ocean climate system.
    - b. To provide modelers with initial conditions, boundary conditions and validation data sets.
    - c. To provide sea-truth data for satellite algorithms and studies.
    - d. To plan a monitoring network for the Global Ocean Observing System decadal and annual variability will be needed.
- B. Substantial amounts of data are known to exist in a number of countries.
  - 1. A number of examples were given including MBT data in both the U.S. and the former Soviet Union.
  - 2. In order to avoid duplication of effort an international Data Archeology Project is strongly recommended.
- C. We need to minimize the number of different formats used by scientists to submit oceanographic data?
- D. How can we assist Lesser Developed Countries?
  - 1. Provision of PC's as well as CD-ROM readers and data sets was suggested.

## Satellite Altimetry

---

*Robert Cheney*

### Summary

Since altimetry data are not really old enough to use the term data archaeology, Mr. Cheney referred to the stewardship of these data. He noted that it is very important to document the basis for an altimetry data set as the algorithms and corrections used to arrive at the Geophysical Data Record (GDR) have been improving and are continuing to improve the precision of sea level data derived from altimetry.

He noted that the GEOSAT Exact Repeat Mission (ERM) data set has recently been reprocessed by his organization in the National Ocean Service of NOAA and made available to the scientific community on CD-ROM disks by the National Oceanographic Data Center of the U.S. (NODC). The new data set contains a satellite orbit more precise by an order of magnitude together with an improved water vapor correction. A new, comprehensive GDR Handbook has also been prepared.

Cross over differences have been used on the classified portion of GEOSAT in lieu of the actual orbits. These data are being used to analyze sea level differences. The cross over data are also available from NODC on CD-ROM disks. The original data for GEOSAT are stored on about 5,000 low density tapes. Since these tapes will eventually deteriorate, there is a question of whether these data should be preserved, perhaps on optical disks. Precision of the GDRs has been improved, but there may be additional factors discovered as new altimetry missions are launched.

Mr. Cheney then proceeded to show examples of how the data are processed and interpreted. He showed examples of time series analyses in the Atlantic in which he and Bruce Douglas looked at sea level variability in 2° by 1° cells. The analyses and reanalyses used to derive the best precision were described. The use of historical tide gauge records to improve the GDR were shown. This again raises the question of preservation of original records so that better quality output can be derived upon reanalysis. What has been learned from this work may be applied to TOPEX/Poseidon which will test whether further improvements can be achieved.

Finally, Mr. Cheney illustrated the potential of altimetric data to measure changes in global sea level. Although a longer time series will be needed techniques developed using GEOSAT data have already revealed possible errors in the ionospheric correction so that they are now investigating improvements that can

be made in the ionospheric model. Since TOPEX will measure the ionosphere this should not be a problem for data from that mission. Other possible improvements to the data were discussed. Raw ERS 1 altimetry are now being received and GDRs are processed by NOAA. Cross over differences from these data are being used to map sea level data in the same reference plane as the GEOSAT data, so that the time series can be extended in a way that is scientifically valid.

## High Resolution Modeling of the Global Thermohaline Circulation

---

*Albert Semtner*

### **Abstract**

Historical data have a variety of uses in ocean modeling. Surface data often help take the place of poorly known surface fluxes. Subsurface data are used to constrain models in a variety of ways, usually classified as diagnostic, robust-diagnostic, and free-thermocline. We designate a new method of forcing only the upper water column in water-mass production regions as 'convective forcing'. To the extent that data are not used in forcing or constraining a model, they may play a vital role in the initialization and/or validation of that model.

The judicious use of data in our high-resolution global ocean model enables the determination of the thermohaline circulation to an accuracy that would presently be impossible with a purely prognostic integration. A global 'conveyor-belt' circulation emerges that consists of relatively high-speed western boundary undercurrents, portions of the Antarctic Circumpolar Current, and equatorial deep jets in the Pacific. These are connected by returning near-surface flow through Indonesia and intermediate flow through the Drake Passage. Recent integrations in both the free-thermocline and the convective-forcing modes indicate that the deep circulations inferred by the two methods are nearly identical, giving added confidence in the overall results.

There are continuing needs for high-quality historical data. Specific needs are for high-resolution local datasets in model verification, high-quality datasets for convective forcing, and large-scale density fields for initialization of poorly sampled southern ocean regions.

## **Data Archaeology at ICES**

---

*H.D. Dooley*

### **Introduction**

This paper provides a brief overview of the function of the International Council for the Exploration of the Sea (ICES), both past and present, in particular in the context of its interest in compiling oceanographic data sets. Details are provided of the procedures it adopted to ensure adequate internationally collaborative marine investigations during the first part of the century, such as how it provided a forum for action by its member states, how it coordinated and published the results of scientific programmes, and how it provided a foundation, through scientists employed in the ICES Office, for the establishment of the original oceanographic marine databases and associated products, and the scientific interpretation of the results. The growth and expansion of this area of ICES activity is then traced, taking into account the changing conditions for oceanographic data management resulting from the establishment of the National Data Centres, as well as the World Data Centres for Oceanography, which were created to meet the needs of the International Geophysical Year (IGY). Finally, there is a discussion of the way in which the very existence of ICES has proved to be a valuable source of old data, some of which have not yet been digitized, but which can be readily retrieved because they have been very carefully documented throughout the years. Lessons from this activity are noted, and suggestions made on how the past experiences of ICES can be utilized to ensure the availability of marine data to present and future generations of scientists.

### **The International Council for the Exploration of the Sea**

ICES was formed in 1902 with a primary remit to provide scientific advice on the state of fish stocks in the Northeast Atlantic, in particular the fish stocks of the North Sea and the Baltic. It was recognized that the accuracy of this advice depended very much on a detailed knowledge of the state of the marine ecosystem. Hence the initial ICES activities leaned heavily towards the establishment of an international data set of physical, chemical, and biological oceanographic parameters which would form the basis of products to be made available for the use of fishery biologists.

The basic structure of ICES was then as it is today, that is, it had a number of committees which covered most marine disciplines (but not marine geology), whose members were chosen experts in relevant fields. There were eight Member Countries in 1902, which have now grown to 17, all coastal states of the North

Atlantic, the North Sea, and the Baltic. At the time of its formation, an Office to coordinate these activities was set up in Copenhagen, which was manned by scientific staff who provided services to the ICES community, not least of which was the provision of internationally consistent data sets. Hydrography (i.e., physical and chemical oceanography) was a very important component of the early ICES, with one of the two senior staff being a physical oceanographer (Martin Knudsen), who was in charge of the "Service Hydrographique" for more than 40 years.

The present-day ICES is basically similar to the one that was created in 1902. It still has an office in Copenhagen, now called the ICES Secretariat which has a staff of 25 professional and secretarial staff. The number of ICES Committees has expanded to cover most areas of relevance to marine living resources. In addition to these "science" committees, ICES has in recent decades created two advisory committees, one concerned with the management of fish stocks, the other concerned with the management of the marine environment, which was created as a result of the increasing threat posed by man's activities. Although science-based discussion and research remain a vital part of ICES, mainly via its other committees these two committees now form the basis and incentive for most of ICES' applied activities. Below these committees are the working and study groups which at present number about 100. These groups provide the expert analysis and opinion on which ICES advice and initiatives are based. They make use of various databases that are maintained at ICES, including those on fishery biology, fishery statistics, marine contamination, and oceanography. Every effort is made, as before, to ensure the consistency of the international data in these databases by intensive quality assurance of the data, backed up by the rigorous application of standards and frequent intercalibration exercises.

### **Early Coordination of Oceanographic Programmes**

Following the approval of a programme for the hydrographic and biological work in the northern parts of the Atlantic Ocean, the North Sea, and the Baltic Sea in 1901, an International Council and an International Laboratory to provide Standard Seawater were established. The main function of this Council was to sustain international collaboration in marine research, and to steer and publish the work. The nature of this research underwent continuous scrutiny, and there is no doubt that the data now available to the marine community were determined by the recommendations made by ICES. The progress in understanding and the evolution of scientific programmes were carefully documented in ICES reports (specifically the ICES "Publications de Circomstance"), which summarize on a grand scale the management of what can be seen as a 50-year-long oceanographic project.

A typical example of the direction which ICES provided can be found in the 1924 annual report of the Council, which stated:

The programme outlined in 1922 is recommended for continuation with certain changes to be introduced as a result of the progress of research: for instance the collection of water samples on the English light vessels to be carried out every fourth day instead of daily, and the saving attained to be allotted to the institution of a new Atlantic Route.

ICES was also attentive to the need for new techniques for measuring the ocean, and many new programmes had their infancy in ICES resolutions. For example, also in 1922, ICES was to recommend

Experiments to be carried out by England with drift indicating instruments, which provided the foundation of many years of research on the water circulation of the North Atlantic.

### **Publication of Oceanographic Data**

In 1902 ICES, in accordance with the recommendations of the International Conference that led to its formation, commenced publication of the *Bulletin Hydrographique*, a responsibility delegated to the Hydrographic Department of the ICES Bureau, which was to become known as the ICES "Service Hydrographique" in 1926. This publication, which appeared annually until 1956 — data were published retrospectively for the war years — lists data from hydrographic stations in the North Sea, Baltic Sea, and the Northeast Atlantic, including waters around Greenland. In addition to the profile data, many hundreds of thousands of entries on ship track temperature and salinity were also listed. These data include the so-called "Route" data, a series of ship routes across which observations were regularly taken. In many cases ICES received the original thermograph charts from these cruises, from which the data were listed and published along with the actual charts. ICES placed much emphasis on the need to "rescue" and publish data in order to make them available as soon as possible, a policy which it pursued with considerable energy and single-mindedness, as depicted in the following extract from the report of the 1935 meeting of the ICES Hydrographical Committee:

The "Dana" was commissioned from June 6th to 22nd on which date she was rammed by a German trawler and foundered near the Dogger Bank. Most of the hydrographical data were saved and will appear in the *Bulletin Hydrographique*

Figure 1 shows the extent to which the "route" and light vessel data have been digitized, based on the data sets available at NODC and ICES. Clearly there are serious shortfalls that must be rectified as soon as possible.

From the beginning, these data lists were accompanied by details of methods and analysis, as well as track charts and distribution maps. In addition the staff of the Service Hydrographique, under the leadership of Professor Martin Knudsen,

would utilize and interpret these data in a way that could be of use to fishery scientists in particular. Atlases were prepared and products relating to time series of anomalies of temperature and salinity were regularly produced, as well as accounts of the scientific analysis of the data.

Although the primary data concerned temperature and salinity, the *Bulletin Hydrographique* also contained listings of chemical and biological (plankton) data, as well as descriptive details of the method of collection, for example. In the beginning all these data were listed by country and date, but from 1936 on the data were geographically sorted by date of measurement following the introduction of the Card Index (see below).

Although most of the hydrographic data collected in the ICES area up to 1956 were published in the *Bulletin Hydrographique*, this was not always the case. The alternative location for publication was always noted by ICES in its annual reports, thus simplifying the task of ensuring that these data have remained available to the scientific community. For example, in its 1924 report, ICES noted:

*A Bulletin Hydrographique* containing the material for 1924 will be published on the same lines as the preceding four years, and to contain also the English Channel surface observations of temperature and salinities, if these observations are not published in the report of the Committee of the Atlantic Slope.

Indeed, the reports of the Atlantic Slope Committee, which were produced during the 1920s and 1930s, contain a wealth of hydrographic data for this period for the continental shelf and deep water areas to the south and west of the UK, Ireland, France, Spain, and Portugal. Although the interests of the Atlantic Slope Committee were primarily related to fisheries (in particular mackerel) questions, this series of reports provides additional detailed scientific interpretation of the hydrographic data published therein.

In the mid-1930s ICES agreed to an initiative of its then Administrative Secretary, Cdr Nellemose, to "automate" its hydrographic and biological data, by creating a Central Card Index of all surface and profile hydrographic data that had been published in its *Bulletin Hydrographique* and other ICES publications such as the Atlantic Slope Committee reports and also of data published at the National level. The hydrographic element of this index is still preserved in the ICES archives, with each card carefully cross-referenced to its source. In 1956, when this activity was stopped along with the cessation of the publication of the *Bulletin Hydrographique* because there was now too much material being produced each year for the Service Hydrographique to handle, there were almost 200,000 cards which were arranged by position, year, and month. Until this date the Card Index had served as an aid to the arranging of the entries in *Bulletin Hydrographique*, but more importantly it provided a "database" which was to form the basis of a large number of scientific publications and products describing oceanographic conditions in the ICES area.



From 1957 on, hydrographic data sets submitted to ICES were prepared on punch cards, using the ICES punch card (hydro-chemistry) format which was designed to be similar to the NODC format with whom regular exchange of data was anticipated. Both of these formats are still in use today. For a while the punch card data were published in a new series called the ICES Oceanographic Data Lists (IODL), but this publication survived only six years because of the diminishing interest of the scientific community in using printed data lists. The demise of the IODL was also partly due to the establishment of the World Data Centres, which were originally created to receive data collected during the International Geophysical Year (IGY) in 1958. The establishment of the WDCs implied that all future data would be made available to the scientific community via National Data Centres, which would perform quality control and reformatting of the data. ICES had, however, a continuing need for data in order to meet its commitments with regard to products, and still relied on its Member Countries to supply data, presumably through their National Data Centres. In practice, however, since product preparation also required quality control of data from a perspective not available at the National Centres, e.g., comparisons of multi-national data sets, and because only a very small number of Data Centres equipped to handle oceanographic station data actually came into being in the ICES area, existing arrangements have to a large extent remained in force. Unfortunately, the loss of a commitment to submit data to ICES by institutes in Member Countries has resulted in only a very small percentage of data collected in recent decades being put into the public domain.

This abandonment of data lists in the early 1960s meant that there was now a clear gap in information about who was collecting research cruise data, and where. This situation was remedied in 1967 by the Intergovernmental Oceanographic Commission (IOC) which introduced the first edition of a cruise inventory called "Report on Scientific Cruises and Oceanographic Programmes (ROSCOP) which has subsequently passed through to revisions and is now called the Cruise Summary report (ROSCOP III). In order to identify the data required by ICES scientists, and for the preparation of products, ICES immediately took on the task of coordinating the return of completed forms from its member countries, and published edited versions of them in the successor to the IODL series, ICES Oceanographic Data Lists and Inventories (IODLI). These were published in manuscript until 1975, but a rapid expansion in their use led to the necessity of publishing them in microfiche form until 1983. The handling of these forms was further streamlined in 1984 by their digitization. Now portable computer software is available to allow searches of these forms, which currently number in excess of 11000. This database now serves as the primary means of searching for data sets that have not been made public, and also serves as a catalogue of cruise data sets which have been submitted to ICES.

## **Completeness of Digitized Data Sets Available at ICES**

Given the combination of the thorough published documentation of the past and the relative completeness of its ROSCOP database of the past 25 years, ICES is in a pretty good position to assess what data collected over the past Century have not been released by their originators for use by the international community.

ICES itself was not involved in the huge undertaking of digitizing the data following the establishment of the NODC (Washington) in the early 1960s. Most of these data were of ICES origin, published in ICES publications, but it was only very recently that ICES was able to assess how successful the digitization of data in the early 1960s was in terms of the data it originated. Indeed, ICES had available only the temperature and salinity component of the Bulletin Hydrographique data set, since it possessed no chemical oceanography data prior to 1957. In addition it did not hold any of the data generated by its Atlantic Slope Committee in the 1920s and 1930s, which was a most worrying state of affairs. However, it is now clear that at least 80% of these data are digitized, and why these data could not be accounted for at ICES until recently cannot be readily explained.

It is apparent, thanks to the efforts of NODC, that the majority of the "old" ICES data are digitized. Inevitably errors must have crept into such a huge operation and these are coming to light during the cross-checking being undertaken by ICES at present. Most of the errors arise not from too little data, but too much, as many cruise data sets have found their way into the data set not once, or twice, but on occasion as much as three times. Most of these duplications and triplications have arisen from the incorrect assignment of ship codes, but are relatively easy to locate and therefore eliminate. Systematic cross-checking also reveals a number of omissions. For example the Danish data sets for 1924 and 1926 have been missed, and much of the data and errata published in various appendices to the Bulletin Hydrographique have been missed, for example the 132-station cruise of the Norwegian ship "Heimland" to the Denmark Straits in 1932. The precise documentation of this period means that the identification of missing data for this period is relatively straightforward, but the presence of some data at ICES which must have been received at some time from NODC, but which is no longer at NODC, is indeed puzzling.

## **Examples of Time Series Data at ICES**

In recent years ICES has been expending effort on digitizing Russian data sets collected mainly as part of Soviet section and Weather Ship programmes. These data had been delivered to the World Data Centre A (WDCA) and, in spite of their limited accuracy (salinity is accurate to about 0.05), it was felt that they would provide a valuable contribution to our understanding of time series processes in the North Atlantic. A total of about 10000 deep water stations were digitized as

part of this cooperation with WDCA. Data from Ocean Weather Ship "Charlie", which was situated about 200 miles south of Iceland in the Central North Atlantic, was believed to be a particularly valuable data set. The scale of effort was immense, with hydro-chemistry stations being worked six times daily, every day from mid-1975 to the end of February 1990. For ten years prior to 1975, this station was occupied somewhat less frequently by the USA. Thus as a time series, the data from OWS "Charlie" represent one of the most intensive that is likely to become available, and providing a unique opportunity to evaluate the time scales of variability in this part of the Atlantic. Figure 2 is presented as an example of this. It shows monthly averaged data for the period 1975-1985 at Station Charlie, and variability at various time scales is clearly apparent. It is also clear that these scales of variability would not necessarily be apparent from less intensive sampling programmes. The most dominant scale in these data is one at ten-year periodicity, which occurs in phase throughout the water column at Charlie. This scale is confirmed by the full Charlie data set from 1965 to 1989. Throughout this period, salinity and temperature were at their minimum in mid-decade, a fact which influenced the interpretation of the mechanisms giving rise to the mid-1970s low-salinity anomaly that had major implications for the ecology of the Northeast Atlantic at that time. The fact that the mid-1980s minimum in temperature and salinity at Charlie was even greater in the mid-1980s implies that factors that resulted in the mid 1970s anomaly have not yet been fully explained. Figure 3, compiled from data stored at ICES, shows the magnitude of the mid-1970s anomaly in the Faroe-Shetland Channel, and illustrates the unique nature of this event.

Data sets such as those available for OWS "Charlie" will almost certainly prove useful in determining the intensity of sampling required in order to establish without ambiguity the natural scale and range of oceanic processes. From a data centre point of view, knowledge of such ranges is important for assessing outliers in data sets. In the English Channel, for example, data being currently reported to ICES show salinity levels more than two standard deviations in excess of the values collected throughout the twentieth century. The problem is that the intensity of sampling in this area is so poor that the statistical basis for these data is unreliable. However, the data received are confirmed from two sources, one of which was also from a cruise that worked other areas where comparisons with a third ship were possible. This led to the conclusion that the salinity outliers of 1991 in the English Channel are indeed valid data, and that values of 35.55 in salinity are some 0.2 higher than observed before. The poor overall data coverage, however, leads us to draw back from the conclusion that these values are "exceptional".

In locations of suppressed high-frequency variability, relatively sparse data sets are probably sufficient for filtering out the effects of ocean change. For example, the deep water in the Skagerrak, an area in the North Sea lying between Norway, Sweden, and Denmark, is a fairly good indicator of changing conditions in the North Sea, and responds well to changing density as a result of changes in temperature and salinity, especially in winter. At this location one value a year is

probably enough to give confidence in the distributions as shown in Figure 4, which shows the annual mean values of temperature and salinity at 600 m depth in the Skagerrak. Both the temperature and salinity distributions tell a story that can be readily linked to climatic events during the century. For example, the well-documented cold winters in the northern North Sea are clear, as well as the effects of the sequence of four exceptionally warm winters that are occurring up to the present. Similarly, the salinity picture shows a gradual decline in peak salinity values since 1978. This year is an important one from the point of view of conditions in the Baltic Sea, as it was the last year in which there was a substantial inflow of "new" water to the Baltic. As a result the Baltic is gradually stagnating, with large areas of hydrogen sulphide forming, much to the detriment of the commercial fisheries in the area. The Skagerrak is the "open sea" end of the Baltic Sea, and conditions there may have a major impact on Baltic exchange processes.

### **Current Acquisition of Oceanographic Profile Data - Successes and Problems**

At the present time the ICES Oceanographic Data Centre has received and quality-controlled more than 6000 profiles of CTD and nutrient data for the year 1990 alone. More than half of these are for the North Sea. This suggests that current data exchange is in a fairly healthy state. However, there is no room for complacency as the true situation is one about which we should be extremely concerned. In particular the following should be noted:

- a) Many of the data were accrued because the submitter was obliged to contribute to specific projects for which ICES is the project data centre, viz. SKAGEX (Skagerrak Experiment), NANSEN (North Atlantic—Norwegian Sea Exchange), the NSTF (North Sea Task Force) and the IYFS (International Young Fish Survey). These data are at present available only to participants in these projects.
- b) Exclusive of these projects, cruise summary reports indicate that less than 10% of collected data have been submitted for this year.
- c) Less than 10% of the data were submitted via the approved routes of the International Ocean Data Exchange (IODE).
- d) No internationally agreed formats, apart from the ones approved by ICES, were used.
- e) But, apart from submissions from four institutes, the formats used by submitters mostly demonstrated a serious lack of understanding of how data sets should be structured. The mode of submission generally bordered on anarchy in spite of the detailed specifications given to participants. Many of these data sets had to be submitted more than once because of ambiguous structures. A total of 34 different formats (structures) were used to submit data, the majority on DOS diskettes.
- f) Quality control procedures are being dominated by the need to check the conversion from the user formats. A particular problem lies in checking users'

undefined "missing data" fields, which have been defined in as many as five different ways within a data set.

Thus, although relatively large amounts of station data profile data have been made available to ICES in a timely way, the acquisition of these data sets is fraught with problems, which implies that the present successes cannot be sustained indefinitely. Too many data sets are still missing, a situation that has been common throughout the last two decades.

Efforts must be made to wrest these data sets from institutes, but options for doing this are limited. One option open to ICES is to withhold service from sources which are requesters but reluctant suppliers, and to exercise this authority. Other possibilities must be considered, as this one option is not sufficient to lead to the release of most of the data sets. In addition to the classical CTD/bottle station data, efforts should be made immediately to retrieve similar data from other instrument platforms, for example seasoar- and batfish-type data. It should also be recalled that the area of activity to which our predecessors in the first part of the century applied so much energy, was the acquisition of surface temperature and salinity data obtained whilst ships were on passage. We should learn from this example, and attempt to acquire the huge volumes of data collected by thermo-salinographs which are routinely obtained and calibrated on most research-vessel cruises. This instrument has been used routinely for almost 20 years, yet not one data point has been acquired by data centres from what must be several million miles of data.

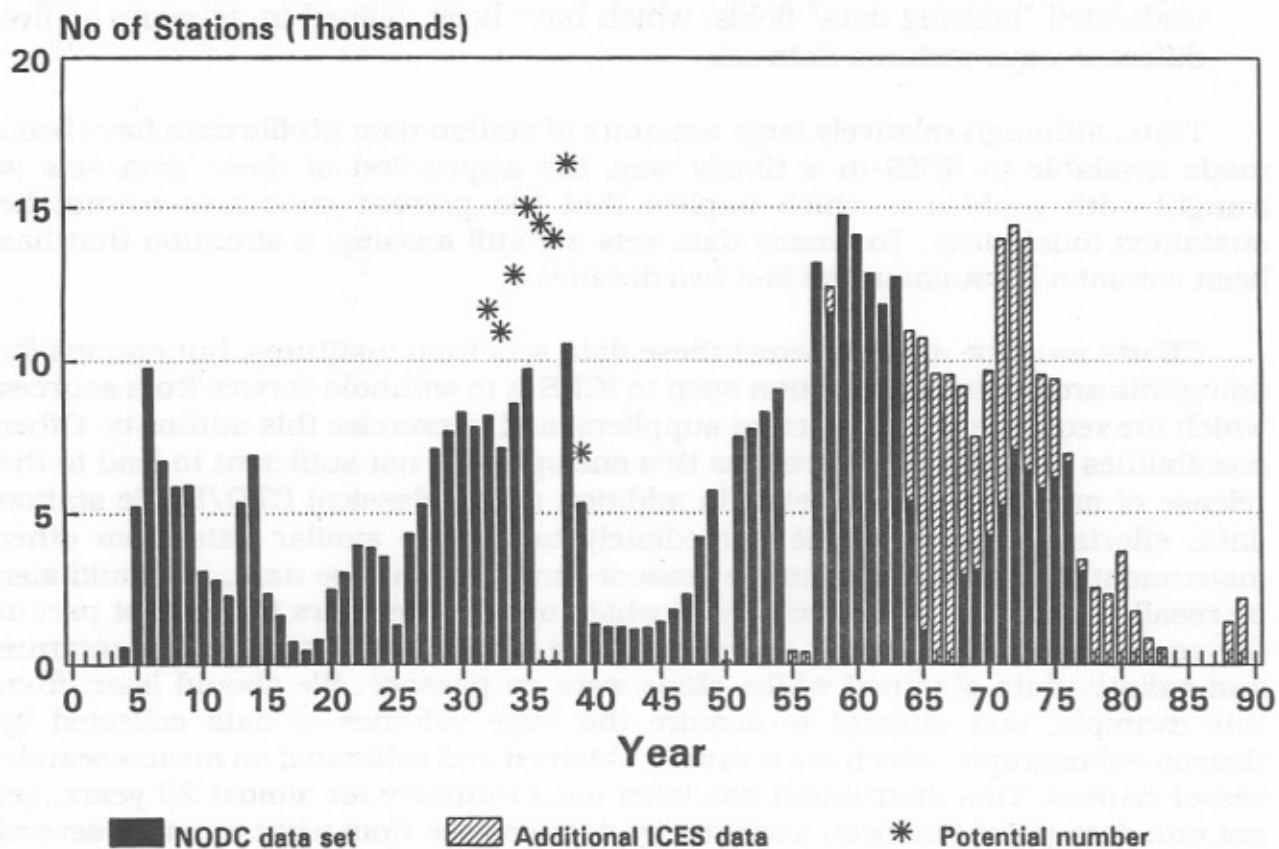
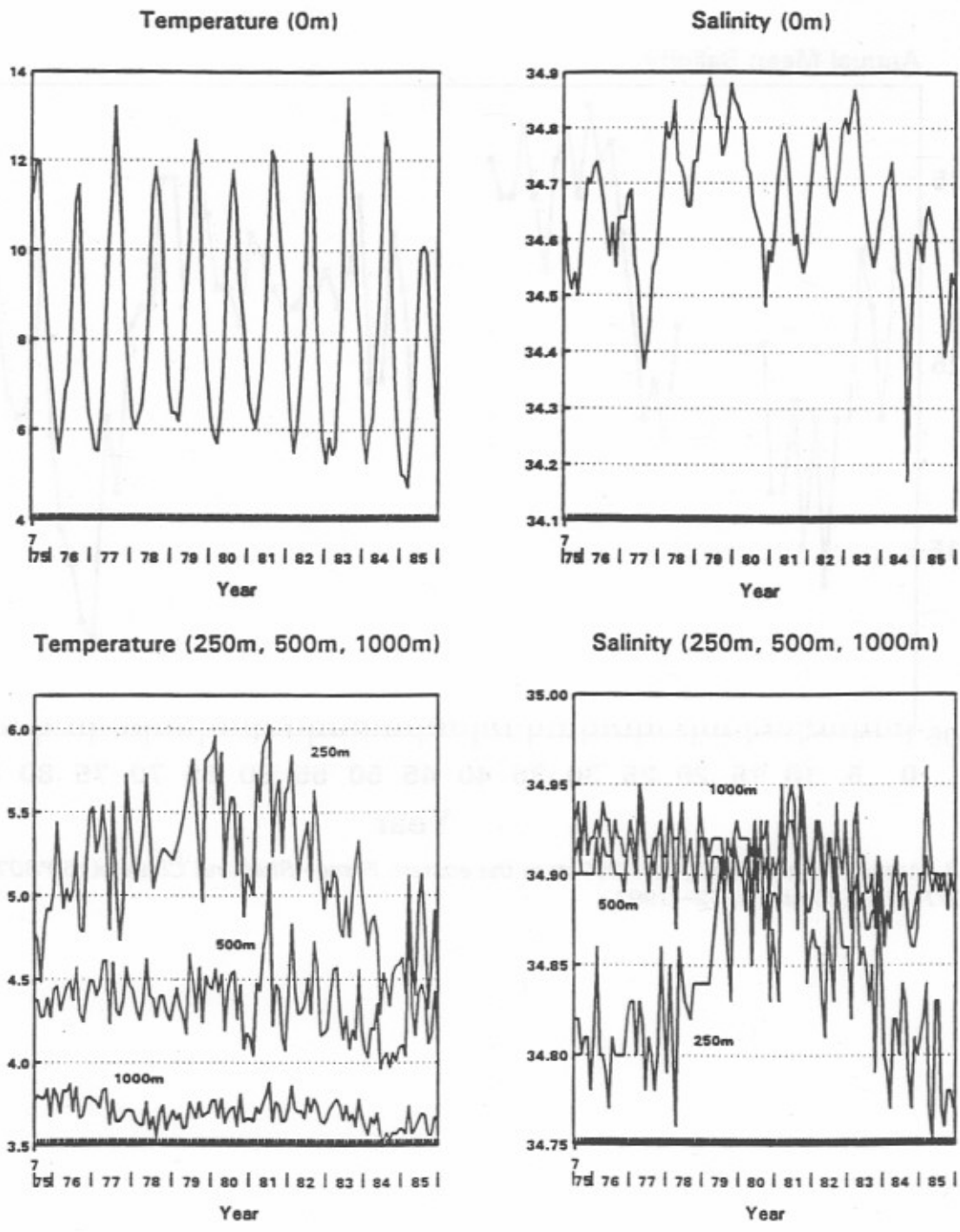
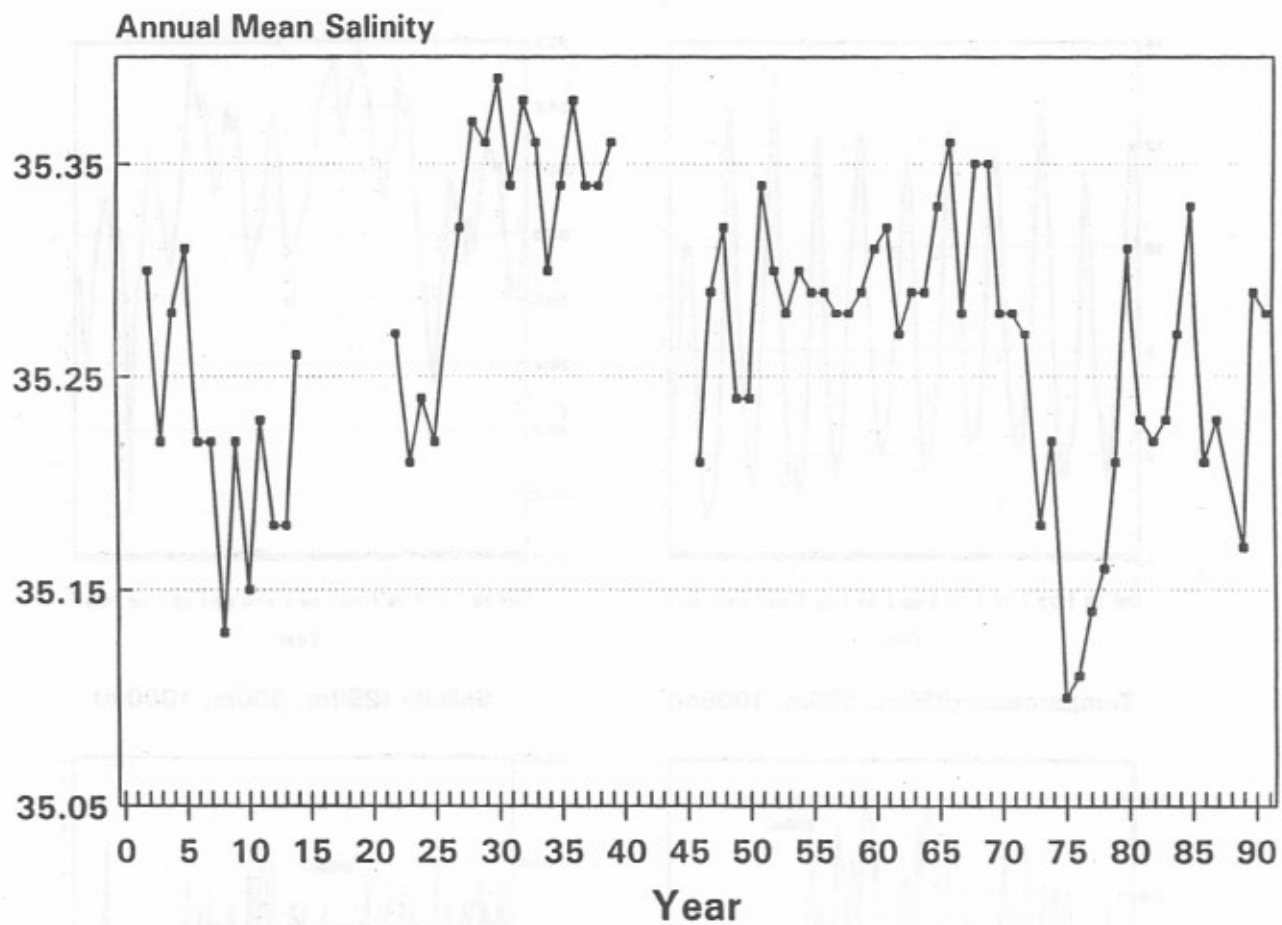

Fig. 1. Number of surface temperature and salinity observations in the NODC and ICES surface data files, 1900—1990. The potential numbers during the 1930s refer to the number of observations listed in the *Bulletin Hydrographique*. (Similar numbers not published in other decades).



(ICES Data Bank)

Fig. 2. Time series at OWS "Charlie", 1975—1985.



*Fig. 3. Annual mean salinity at 0-300 m in the eastern Faroe-Shetland Channel (59°30'N 7°W to 63°00'N 1°E, ±20 nm), 1902-1991.*



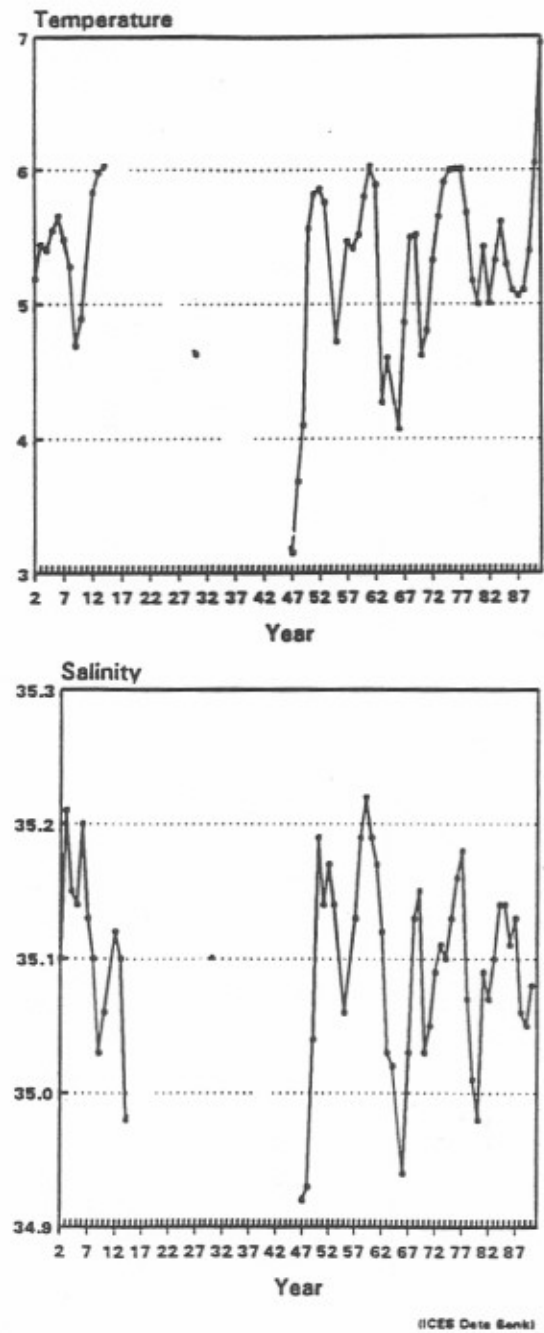

Fig. 4. Annual mean temperature and salinity at 600m in the Skagerrak, 1902—1991.

## **Data Availability and Data Archeology from the Former Soviet Union**

---

*Yuri Sychev, Nickolai Mikhailov*

### **1 Introduction**

Acquisition of data on the ocean is believed to start in 1872, when the Royal Navy ship "Challenger" performed oceanographic stations its round-world voyage (1872-1876). First oceanographic studies of the World Ocean refer to the 80s second half of the XIX century. During its round-world expedition "Vityaz" (1886-1889) headed by S.O.Markov, performed hydrological measurements in the Baltic Sea, Atlantic and Pacific Oceans. According to information available the regular expedition observations (prototype of future complex international program on the ocean research) started in the second half of 80s last century under the auspice of Kiev commission for exploration of German Seas. Systematic hydrological observations were organized by Hydrographic Department of Russia in 1876-1879 according to the program similar to the Kiev one and observations were regularly made by ships of custom service over the Russian area of the Baltic Sea.

The increasing demands in oceanographic data contributed to considerable progress in exploration of the World ocean during current century whole tendency to increase and become more significant has been observed for the last 30-40 years. Most probably various expeditions which were carried out during International Geophysical Year in different regions of the World Ocean are to be reference point in performing intensive oceanographic observations of Marine environment.

In the former USSR oceanographic observations are made by research and hydrographic vessels, commercial and fishery ships as well as and oil production platforms, coastal hydrometeorological station and other observing platforms. Oceanographic observations data, available from main sources of information on the ocean-research vessels - are also considered in the report.

According to RIHMI-WDC NODC information above 1348 national RVs have been functioning in the World Ocean in the course of all historic period, most part of which (above 950 ships) refer to RVs with small displacement having performed observations in former USSR seas: White Sea, Barents Sea, Baltic Sea, Black Sea, Caspian Sea, Sea of Japan, Sea of Okhotsk, Bering Sea and Arctic Seas. In the last decade general number of RVs carrying out expeditions research in the oceans and seas amounted to 250-300 vessels, small displacement included.

Expedition research efforts have been mainly realized under five former USSR agencies: State Committee for Hydrometeorology, Ministry of Fisheries, Academy

of Sciences, Main Department of Fleet Navigation and Oceanography and State Committee for People's Education. The averaged number of expeditions per year amounted to 600-650 with amount of information obtained about 30,0 Mbyte.

Observation data have been concentrated at agency centres of data acquisition and also have been sent via mail and telegraph channels to NODC with a view to creating the state oceanographic observations data holdings. The way of data transmission was regulated by some resolution of the former USSR Government and the ship owners were obliged to pass the materials obtained in expeditions to the National Oceanographic Data Centre, which was operating as a department of Research Institute of Hydrometeorological Information - World Data Centre (RIHMI-WDC).

Distribution of major functions on data processing and dissemination as well as data exchange problems between RIHMI-WDC NODC and the Centres have been coordinated at the level of the former USSR marine agencies. On the whole oceanographic data processing was rather study at the state level, being provided by interaction between data suppliers, Centres and RIHMI-WDC NODC for implementation of the scheme considered with respect to organization, methodology, software, technology and information aspects.

## **2 Data Collection and Accumulation**

Functioning of the multilevel system of oceanographic data processing provided for a high enough level of data collection completeness and preservation of data holdings of oceanographic observations. Oceanographic data collection in this form started in the second half of the sixties after RIHMI-WDC NODC had been established. Since 1969-1970, data for the expedition investigations, which make up not less than 85-90% for the oceans and foreign seas and about 70-80% of data for the former USSR/CIS seas, were systematically accumulated at the NODC. The major part of materials is submitted to the NODC in a standard form in line with the "Scheme of the scientific and technical report on r/v cruise" which includes the regulation for the presentation and transfer of data for the expedition investigations. In 1980-1982 a certain amount of data which are obtained from computers on board the r/v, became available at the NODC on magnetic tapes. So, the last version of the "Scheme of the scientific and technical report on r/v cruise" includes the descriptions of oceanographic data record formats.

To provide the completeness of data acquisition NODC performed early control of observation materials available from the ship-owners and centres and ones in 5-7 years checked availability of the archival historical data in RIHMI-WDC with reference to materials available with suppliers and agency data centres. Data of research cruises carried out outside the country, are submitted to RIHMI-WDC via the IOC/IODE system using WDC changed and are also resulted from operation of data acquisition centres (TROPEX, MEDALPEX) under different projects and bilateral exchange of observation data.

At the present time NODC data are collected, which were submitted by 954 Soviet and 1325 foreign ships whose general number equals to 1837.9 thousand of oceanographic stations and 395 thousand of bathythermograph soundings.

National data for oceans and foreign seas have been submitted by 6.9 thousand of RVs cruises for the period 1902-1990 and amount to about 40 % (with reference to oceanographic stations number) from the total number of data sets collected. Significant volume of oceanographic data has been collected over the former USSR sea areas. In such a case the main part of marine data has been obtained at fixed observation sites - cruise sites, stations of standard and secular sections. Participation in international cooperation on oceanographic data acquisition and processing made it possible to significantly enlarge oceanographic data holdings.

The composition of oceanographic observation types and parameters, which are included into data holding, is varied and depends on the time of observations, the vessel's equipment, the investigation program and other reasons. Before the sixties, the r/v carried out, mainly, hydrological and hydrochemical observations, bathythermagraphical observations, current observations and simultaneous meteorological observations. During the last 20 years the range of the observable parameters became substantially wider and currently it includes eleven types of observations. It is necessary to note, that hydrological and hydrochemical observations were carried out during the greater percent of cruises, collected at RIHMI-WDC NODC.

### **3 Archival Data Set Formation**

#### **3.1 Primary Data Processing and Archiving**

Archival data sets creation procedures which are realized, with software in OC EC computer and MS DOC environment provide for data assimilation, which are received from different sources and on different media (manuscripts, magnetic types, diskettes), and for the preparation of a series of typical archival data sets on magnetic types which are oriented on long data storage.

Data quality control is the most laborious elements of this procedures. Data QC which are used to prepare archival data sets of the deep-sea hydrological and hydrochemical observations, are similar to QC GTSP procedures, which are the following:

- Impossible time
- impossible coordinates
- Land - sea
- Impossible depth
- Impossible instrument code
- Impossible parameter values
- Profile 10° square profile envelope( for the Atlantic and Pacific ocean to the

- equator)
- Regional profile envelope (for seas of the former USSR)
- Increasing depth
- Constant profile
- Spike (top, within the profile, bottom)
- Kink
- Density Inversion

Archival data set creation provided the basis for the technical availability of accumulated historical observations data. In 1983-1985 the time lag from data production to their inclusion into archival data sets amounted to 1.0-1.5 years. During the last years the time lag increased to 2.0-2.5 years due to the functioning difficulties of oceanographic data collection and processing system. The final production of the scheme block 2 is the archival sets on magnetic tape and documentation with the archive description, which includes information about magnetic tape content, quality procedures, data record structure and other characteristics of archival set.

#### **4 Integrated Data Set Creation**

Typical archival sets are oriented on the long data storage and, thus, are characterized by a certain redundancy of record formats and by some inconvenience in their practical use. To increase data technical availability NODC carries out the project on the creation of the Integrated Global data set of the deep-sea observations set GLOBAL, which fulfills the current requirements for data availability and data handling convenience. The GLOBAL data set has the next composition:

- bathymetric data ( Nansen bottle or similar instruments)
- temperature, salinity, PH, O<sub>2</sub>, alkalinity, nitrites, nitrates and other hydrochemical characteristics;
- bathythermograph data (MBT,XBT)
- temperature;
- sounding sets (of CTD and STD type)
- temperature and salinity.

There are four main levels in the GLOBAL data set:

- level I/basic level (hydrological and hydrochemical data arranged by Marsden squares);
- level II (data interpolated for the standard depths);
- level III (climatic characteristics in Marsden squares);
- level IV (climatic characteristics in regular grid-point form).

At present the preparation of GLOBAL level I data is being finalized. I,III,IV level sets for the sea water temperature and salinity have been prepared for individual regions.

The current version of the GLOBAL set of the basic level includes the observation data, registered in the archival sets as of January, 1, 1991 (data from the beginning of observations to 1988 or to 1990 for individual regions). To obtain the characteristics of the presence and time-space distribution of oceanographic observation data, available at RIHMI-WDC NODC, metadata from the GLOBAL set of the basic level were processed for the Soviet cruise data and the USA. Time diagram (Fig. ) show data distribution over years of observations for the Atlantic Pacific and Indian Ocean, individually and together. It is seen from the diagram, that the main part of data falls at the last 30 years. In this case, the largest number of observations for this period was carried out for the Atlantic Ocean.

## 5 Data Archaeology

Retrieval of archival data available in manuscripts and not entered on technical media (data archaeology) is one of the main ways of increasing historical data quantity. Since entering of observational data on technical media is a rather time and money consuming work, it is no wonder that in some cases large quantities of these data can be found. In 1991 the NODC of RIHMI-WDC made great efforts to search and catalog these data. There are two main data sources: WDC archives with a large amount of information being held as hard copies and archives of national marine institutions not received by RIHMI-WDC for various reasons.

### 5.1 WDC-B Data

At present the WDC-B holds data from almost 3,000 cruises of 54 foreign countries containing about 192,000 hydrological stations. General distribution of the number of cruises for decades is shown in Fig. \_\_. It shows that half of the data obtained is referred to the last two decades. When moving from the current time to the beginning of the century the data amount decreases but remains significant since these historical data are of great importance. 74 cruises are referred to the first half of the century and 9 ones to the first two decades. Only 13 countries have shares exceeding 1% of the whole data amount. Their total share is about 85%, more than 60% being obtained from 4 countries: Japan - 27%, USA - 17.5%, Canada - 9.3%, Germany - 8%.

As it was expected the observations were mostly made in the North Atlantic (30%) and the North Pacific (39.6%). The South Atlantic and South Pacific account for 5.1% and 7.3% respectively, the Indian Ocean - about 4% and the Arctic Ocean and adjacent seas - about 2.5% of the observations made. Peculiarities of the time-space distribution of the WDC data not recorded on technical media are shown on the Fig. \_\_.

### 5.2 National Data

Six month retrieval made it possible for the NODC to obtain and catalog the data held in manuscripts from nearly 1,000 cruises (about 56,000 hydrological

stations) of Soviet research vessels. Over 60% of data were obtained from cruises of the 1985-1990 period which reveals a complicated final stage of the Soviet state started in 1985. The remaining 30% are time distributed in a natural fashion (Fig.\_\_). 35.5% of cruises available as archaeological data before 1985 apply to the seas adjacent to the CIS (Commonwealth of Independent States). Cruises in foreign seas and oceans display stronger attraction to the Northern Hemisphere than average one for the WDC data and that is quite natural (Fig.\_\_). As expert estimates show the further retrieval of national data similar to the one made will make it possible to use widely the data from some 500 - 800 cruises performed by marine institutions of the former USSR.

The large amount of the data held in manuscripts - about 56,000 national and 192,000 foreign hydrological stations - will require great efforts for their recording. It will take approximately 2,000-2,500 man\*month with a total cost of about 2.5 million roubles in late 1991 prices.

### **5.3 Data Availability Policy**

The current status of the former USSR states give rise to difficulties in the information exchange, oceanographic one in particular. At present the process of establishing of state structures and signing of vital interstate agreements is going on. Until the process is over it is too early to speak of the mutual commitments of the CIS members in the field of the World Ocean research and therefore in the field of data exchange and collection. Nevertheless Russia is ready to meet all the commitments of the former USSR in the World Ocean research. The appearance of the official documents confirming this readiness is a matter of time. Thus, observational data being a national archive as of December 1991 are considered as a national Russian archive. The policy of openness implemented in the recent time made it possible to involve some of the classified data in the international exchange. This applies to the data of the Navy. Now the Navy allowed the data from 350,000 MBT soundings for international exchange. Beginning at mid 1992 the Navy is going to pass 5,000 MBT data a year with a delay of a month. The possibility of making deep-sea observations unclassified is being discussed.

In the nearest future Russia is likely to reduce significantly a number of new observations for well known regions. So the retrieval of data from the observations already made, recording them on technical media and creating high quality data sets is one of the main tasks for the Russia data managers.

## **Ocean Climate Data for User Community in West and Central Africa: Needs, Opportunities and Challenges**

---

**S.O. Ojo**

### **Introduction**

The urgent need to improve data delivery systems needed by scientists studying ocean role in climate and climate characteristics has been manifested in recent years because of the unprecedented climatic events experienced in many parts of the world. Indeed, there has been a striking and growing realization by governments and the general public indicating that national economies and human welfare depend on climate and its variability. In West and Central Africa, for instance (Fig. 1) climatic events, which have resulted in floods and droughts, have caused a lot of concern to both governments and people of the region. In particular, the droughts have been so widespread that greater awareness and concern have become generated for the need to find solutions to the problems created by the consequences of the climatic events. Particularly in the southern border regions of the Sahara Desert as well as in the Sahel region, the drought episodes considerably reduced food production and led to series of socioeconomic problems, not only in the areas affected by the droughts, but also in the other parts of West Africa. The various climatic variabilities which have caused the climatic events are no doubt related to the ocean-atmosphere interactions. Unfortunately, not much has been done on the understanding of these interactions, particularly as they affect developing countries. Indeed, not much has been done to develop programmes which will reflect the general concerns and needs for researching into the ocean-atmosphere systems and their implications on man-environmental systems in many developing countries. This is for example, true of West and Central Africa, where compared with the middle latitude countries, much less is known about the characteristics of the ocean-atmosphere systems and their significance on man-environmental systems of the area.

One of the major reasons for the apparent lack of interest for researching into the ocean-atmosphere systems and their implications on man-environmental systems in many countries are concerned with the non availability of data. Thus, to enable researchers to develop greater interests, there is urgent need to improve the data delivery systems needed by scientists studying the ocean's role in climate and climate change; and their implications on man-environmental systems. In the present paper, the need for, the opportunities available, and the challenges for the future of ocean climate data with particular reference to West and Central Africa, are discussed. The paper in particular reviews and critically examined the status of the available data, for example, the length of the data series, the quality and their accessibility to researchers in the region. Other issues discussed include the network and spatial/temporal coverage of the data, the storage and protection of



the data, monitoring and archival and the data management and the user services. The paper also discusses the urgent need to improve ocean climate data management in support of ocean climate research and emphasizes the need for improved local technology, transfer of technology, adaptation of technology transferred, education and training, provision of adequate funding and mobilizing sufficient resources to improve data and cooperation and coordination of efforts at national, regional and international levels.

### **Data Needs**

In general, ocean climate data and information are required for research, application and impact studies. In particular, they are required for describing, understanding and predicting the behaviour and other aspects of ocean-climate systems including man's impacts on climate and the relationship of climate to various aspects of the environmental systems. For example, ocean climate data and information are significant for planning a variety of operational activities, especially the very sensitive ones including those dealing with food production, water resources, energy and human settlements and health. Socioeconomic activities in these sectors have no doubt evolved over a long period of time, and have reflected adaptation to the regional and local climates. Whereas in many developed countries, a reasonably adequate data storage and archival of ocean climate data are characteristic, in West and Central Africa in particular, and may developing countries in general, data storage and archiving are yet to be established.

Different types of ocean-climate data and data bases are required to fulfill the objectives of data monitoring and data collection. In particular, global, regional, national and local data bases are required for application of climate data and information in human activities as well as for the study of the impacts of climatic variability and changes on human activities. Global and regional data are also needed for assessment of global and regional climate conditions, and for scientific research on climate change, climate variability and climate change prediction. The representativeness and the resolution of data are also determined by the natural variability of the parameters being observed and by procedures for averaging the data, which should no doubt meet the requirements for the development and testing of models for ocean-climate services, and needs for various applications.

Among the ocean-climate data needed to respond to the demands of the user community, increase their awareness for the uses of ocean-climate data and information, and improve their capability to employ this information are surface data from synoptic climatological and specialized stations such as radiation station, upper air data and oceanographic data including sea surface temperatures, sub-surface temperatures and sea surface/subsurface salinity. Unfortunately, West and Central Africa has a lot of problems associated with data acquisition and availability, data archiving and the management of data. Thus, the region is faced with the problems of providing adequate services for the user community and assisting the community in using the services. In the following section, some of these problems are discussed.

## Problems of Data

Among the basic problems facing data delivery systems in West and Central Africa are those related to the network and coverage of the data. In all the West and Central Africa countries located along the coast, the length of the data series, the quality of the data, the storage, accessibility and protection of the data are significant problems. For example, until very recently, oceanographic data observations were very irregularly made mainly along the coast between southern Mauritania, across the Gulf of Guinea to northern Angola, and westward to approximately 20°W. Similarly, network stations over the coastal land surface are very inadequate and the coverage of available data cannot meet the target densities set out by WMO for meaningful research, climate application and impact programmes. Also significant is the fact that data in many stations are collected to meet specific research requirements or projects. Data series vary in length of coverage with individual stations in the region. It is in very few stations that data are available for more than fifty years, while in most of the coverage, data are available for less than twenty years. Moreover, most of the data cover only rainfall and sometimes temperature in many locations. Where data have been available for more than twenty years, there have been possibly changes in the station locations and changes in the instruments and exposure, thus creating the problem of comparative analysis of data between the different time periods. Significant problems are also related to data quality, sometimes because of mechanical and human problems. For example, there have been stories of meteorological assistants who merely crook figures in their offices or rooms without actually going into the field to read from the instruments.

Another major problem is concerned with data archiving. In this regards, coordination and collaboration in the different countries or institutions connected with ocean-atmosphere study programmes cannot be overemphasized. Unfortunately, in West and Central Africa, data collection and archiving are not necessarily based on scientific goals and very little research is carried out on ocean climate data. This considerably limits the availability of such data to the user community. Other significant problems which concern data acquisition, archiving and availability are related to the fact that currently most of the available data are found in a variety of sources not always known to the user community. Part of the data are, for example, scattered in libraries, record offices and other places and in most cases, they are usually incomplete, hopelessly inaccurate and of no use for any meaningful research, application or impact studies. Moreover, there is always the possibility of administrative bureaucracy which has for long been recognized, but for which no solution has been found. In many places, quite a significant amount of data is still in raw form, even though these data could be applied to several problems, if they were available in usable format.

Equally important is the fact that most of the available data are located outside West and Central Africa, in countries where a lot of activities related to ocean-atmosphere interface of West and Central Africa are carried out. Examples of these countries are France, Germany and the U.S.A. In France, for instance,

such activities are carried out under the auspices of scientific institutions such as CNRS, CNEXO, and ORSTOM. Unfortunately, none of these institutions which are engaged in promoting research interest in ocean-atmosphere systems in West and Central Africa are strongly based in the region. This makes it difficult to have the research results to become available to scientists and other members of the user community in West and Central Africa, interested in utilizing the results for studies on ocean-atmosphere systems.

### **Data Management and the User Community Services**

A main purpose of the World Climate Data and Monitoring Programme (WCDMP) is to ensure the availability of data which are accessible, exchangeable and acceptable in usable form and time. But, as already emphasized above, most of the data available in West and Central Africa are far from satisfying the qualities of accessibility, exchangeability and acceptability in form and time. Thus, data and information are not readily available to the user community who could need the data for most effective research, application and impact studies and for example, operations and activities related to or influenced by ocean-atmosphere processes. Even if the basic data are conveniently available, they still need to be transformed into derived products specialized to the needs of the users, as is being done in most advanced countries. Thus, unfortunately, the users' needs are far from being met in West and Central Africa.

A lot of these problems are related to data management which are far from ideal and far from meeting the needs of the user community. Data management strategies or techniques are no doubt significant for improved data delivery systems that are needed by scientists studying the ocean role in climate change. Apart from the fact that most available data are found in sources other than meteorological and oceanographic institutions, there is a lack of coordinated efforts for improved data availability, data management and access to data. Indeed, there are a lot of jurisdictional problems which are associated with the collection and synthesizing of the data in order to have them readily available to meet the needs and demands of the user community. It is no doubt urgently necessary to improve data management in the region and organize a timely and direct flow of data and information for easy accessibility. With better management, it would be easier to pinpoint where there are data gaps and augment the data systems. It would also be easier to achieve the much needed expansion of networks, improvement in data collection, data quality control, processing and storage, if necessary, with international assistance and support from developed countries.

### **Other Problems**

Three other categories of problems may be noted. First, there are problems related to technology and technology transfer. Secondly, there are problems

related to education and training, and, thirdly, there are problems related to funding programmes related to data acquisition, archiving and analysis to make them readily available to the user community. No doubt, it seems a fairly evident proposition that the solution of most data problems depend to a large extent on the application of science and technology. In this regards, a lot of cooperation is needed to ensure the transfer of the correct and adequate technology and, where necessary, modifications to these technologies are made within the context of traditional technologies. Over the past few decades, there have been considerable advances in science and technology, and in techniques using satellite data and computer sciences, and a number of ocean-atmospheric modelling techniques have been developed using these technologies. Unfortunately, these advances, which facilitate the provision of ocean climate data and information, and make the application and impact methodologies faster and easier have not been widely applied in West and Central Africa. To scientists from developed countries these technologies are easy and relatively cheap to own. But, to users from the developing countries in general, and West and Central Africa in particular, they are very expensive and are completely not affordable, except through assistance and financial support. There are, no doubt, considerable problems getting the hardware and software to the right place, and for improved data delivery systems, there is need for improved dialogue between developing and developed countries. There is also need for support from developed countries in order to meet the users' needs in the application of technology.

Education and training are also necessary for providing necessary personnel for data delivery systems. No doubt, trained and motivated people are needed to translate available compilation, consolidation and data analysis. They are also required for archiving of data, rescue operations, and for collaborating with users in applying data for solving problems and for impact studies. Special needs for trained personnel in ocean climate data can be perceived for such activities as data processing, computer techniques and onshore and offshore operations related to the users' activities. A basic problem which militates against education and training, as well as other problems relating to ocean climate data, is concerned with mobilizing sufficient resources to meet the financial investment needed to solve the problems. Currently, inadequate funding is characteristic of research activities in West and Central Africa. Of course, it is true that the economies of many of the countries in the region are poor. However, the situation is worsened by the fact that most national governments place very little priorities on programmes of research which would not yield immediate economic and commercial benefits. The situation is so bad that in the universities and some of the research institutions, there are usually no funds available for research of typing or duplicating research papers. In many of the countries, the social status of education and research has been relegated to the background and has become one of the least reckoned with.

Education also involves promotion of awareness of the user community, as regards the availability of the data needed. It also involved interacting with them on the need to make use of the available data in the research activities. It is also

necessary to educate the public on the need to improve data delivery systems, and for the user community to participate in addressing ocean climate issues and develop appropriate responses using the available data required particular in areas which require the provision of courses and skills in the short and medium term, while in the long term international assistance and support should aim at building education and training institutions located in these countries.

## **Conclusions**

The growing recognition of the important role played by ocean climate data in planning national socioeconomic development in West and Central Africa calls for effective action in facing the challenges and opportunities connected with the users' needs for, and services related to ocean climate data. Such data are, no doubt, needed for research into understanding the behaviour of the ocean-atmosphere system and for understanding the processes which determine the climate and climatic variations in the region. In particular, such data are needed for understanding the characteristics of the ocean and the atmosphere as a time dependent system and the extent to which the system is predictable on varying time scales for the purpose of understanding the mechanisms and the processes underlying their predictability.

No doubt, the situation in West and Central Africa illustrate the general problems faced by developing countries in data availability, storage, archiving and retrieval for the users' community. Other problems are related to transfer of technologies, adaptation of technologies transferred, development of local technologies, education and training and problems related to adequate funding. West and Central Africa, in particular, and developing countries in general, also require a lot of cooperation and support at national, regional and international levels to find solutions to these problems. For example, at the national level, the need for governments' support in funding and giving adequate support for promoting efforts at improving the status of data acquisition and availability for the user community cannot be overemphasized. It is also important that there should be collaboration between national governments and international institutions in their efforts to promote data acquisition. There may also be need for assistance in such areas as technical cooperation programmes, for example, in terms of computer and hardware and data processing technology and through the use of satellites and the provision of remotely sensed data and information that can be related to conventional historical measurements taken from the platforms of the sea or land. It may also be remarked that coordination in the establishment of both national and sub-regional ocean climate data banks will considerably enhance the success of efforts towards improvement of data delivery systems in West and Central Africa. Other areas of action include the stimulation of data utilization and promotion of awareness on the availability of data in usable formats, the improvement of data exchange to serve the various needs and the promotion of quality control of the data.

For considerations of improved data delivery systems, the developing countries are currently in a unique and different position compared with the developed countries, and the situation must be so treated, examined and discussed. The present gross inadequacy in the ocean climate data acquisition and availability, data storage and archival, and data management call for concern. Also important is the fact that the few data available are fast deteriorating and need to be rescued, for example, by using some of the available advances in technology (e.g., micro-filming). There is also the urgent need to improve and enlarge the networks of ocean climate data stations, computerize climate data management systems, upgrade the national, regional and the international data management and exchange procedures, and provide opportunities for the provision and international exchange of high quality long term data for climate related studies. It is also important that data should be made available at costs affordable to the users community in West and Central Africa in particular, and the developing countries in general.

Access to data and data products are no doubt prerequisites to improved ocean climate data delivery systems, and to achieve this, improved cooperation and collaboration between developing and developed countries is essential, particularly in the fields of technical assistance and the application of modern tools and techniques for acquiring and storing data. Such technical assistance should include education and training programmes, improved public awareness for the need to improve data delivery systems, assistance in the adaptation of technology transfer, and/or development of affordable low cost, but effective, data acquisition and management strategies which would take maximum advantage of technological advances, and enable the user community in many developing countries to improve their capabilities to use ocean climate data and obtain maximum social and economic benefits under the different environmental sustainability. Thus, with such assistance, it would be possible to obtain ocean climate data needed for the most effective operations of climate sensitive activities, reduce the vulnerability of these activities to climatic hazards and respond positively to the demands of the user community.

# **Effect of Change in the Ocean and on the Life Cycle**

---

*Convener - Hugh Ducklow*

## **Effect of Change in the Ocean and on the Life Cycle**

---

In order to have a more complete discussion of the chemical and biological data management needs in relation to the oceans and climate change this session directed its attention on the Joint Global Ocean Flux Study (JGOFS) and particularly on the 1989 North Atlantic Bloom Experiment (NABE). The talk given by Evans added a more general discussion of data management for satellite derived parameters. Similarly the paper presented by Gamble added a more general discussion on the availability and use of time series biological data. Both of the papers on data management (Flierl & Lowry) resulted in a number of questions and comments both during this session and in formulating recommendations and issues for future discussion. It was noted by many that schemes such as the JGOFS/BOFS Topical Centres in the United Kingdom (and others in WOCE & TOGA) were the best way to ensure rapid delivery and high quality data to project scientists and eventually to the World Data Center system. Although each project has its own variations, each has the characteristic of bringing scientists and data managers together as a team rather than as separate entities.

Introduction of the JGOFS program enabled the participants to focus on a truly multi-disciplinary project. Not only is the program multi-disciplinary, but most of the presentations were on what happened (or is happening) when plans are put into practice. Thus Workshop attendees were able to make recommendations that directly meet the objectives of the Workshop and may also serve as a guideline to other global change research in the future.



## The JGOFS North Atlantic Bloom Experiment An Overview

---

Hugh W. Ducklow

The North Atlantic Bloom Experiment (NABE) of JGOFS presents a unique opportunity and challenge to the data management community because of the diversity and large size of biogeochemical data sets collected (Figure 1). NABE was a pilot study for JGOFS and has also served as a pilot study within the US NODC for management and archiving of the data sets. Here I present an overview to some of the scientific results of NABE, which will be published as an Introduction to a special volume of NABE results in *Deep-Sea Research* later this year. An overview of NABE data management is given elsewhere in the present report.

This is the first collection of papers from the Joint Global Ocean Flux Study (JGOFS). Formed as an international program in 1987, JGOFS has four principal elements: modelling and data management, multidisciplinary regional process studies, a global survey of biogeochemical properties and long-term time series observatories. In 1989-90 JGOFS conducted a pilot process study of the spring phytoplankton bloom, the North Atlantic Bloom Experiment (NABE). JGOFS decided to conduct a large scale, internationally-coordinated pilot study in the North Atlantic because of its proximity to the founding nations of the project, the size and predictability of the bloom and its fundamental impact on ocean biogeochemistry (Billett et al., 1983; Watson and Whitfield, 1985; Pfannkuche, 1992). In 1989, six research vessels from Canada, Germany, The Netherlands, the United Kingdom and the USA and over 200 scientists and students from more than a dozen nations participated in NABE. Some of their initial results are reported in this volume.

The spring bloom in the North Atlantic is one of the most conspicuous seasonal events in the world ocean. Coastal Zone Color Scanner (CZCS) imagery shows that the bloom is manifested as a sudden explosion of ocean color which fills the basin north of about 40 degrees latitude in April and May each year (see cover; ESAIAS et al., 1986; US JGOFS, 1989). It must seem surprising to anyone examining these beautiful images to learn that until the early part of this century, there was scant mention of the bloom in the literature at all. As MILLS (1989, p. 121) states:

"A phenomenon as striking as the sudden appearance of phytoplankton cells during spring in temperate and high latitudes should have been noted very early, perhaps even incorporated into fishermen's folk-wisdom. Yet there is little mention of phenomena that in modern terms would be called the spring bloom in the scientific literature of the early nineteenth century...Plankton blooms, during the first decade of the twentieth

century, were reified; the concept became the expression of a new and influential approach to the biology of the seas."

Mills describes how the bloom concept was defined by the Kiel School of oceanography following Victor Hensen's pioneering Plankton Expedition of 1889 (Mills, 1989). Later the concept was formulated in quantitative terms by Riley (1942) and Sverdrup (1953), following on the initial model provided by Gran and Braarud (1935; see Platt et al., 1991 for a recent discussion). NABE was a centennial celebration of Hensen's expedition (Ducklow, 1989).

Figure 2 shows the oceanographic context of NABE. In the eastern North Atlantic, deep convection in late winter supplies the upper ocean with 2-14 [ $\mu$ ]g-atoms ([ $\mu$ ]Mol) of nitrate which supports new primary production following restratification in April-May. In the absence of removal by zooplankton, this process culminates in the accumulation of phytoplankton biomass. Seven primary locations were occupied during NABE in 1989 (Table 1). Stations at 18 and 72 North were only visited by the METEOR (FRG) during the Hensen centennial "Plankton 89 - Benthos 89" expedition. Passow and Peinert (1992) provide a brief overview of conditions at 18 North in their paper on plankton and particulate fluxes. The stations in the western Atlantic were part of the Canadian JGOFS "Western NABE." HARRISON et al. (1992) is an in-depth analysis of upper ocean processes at the 40 West stations. The stations at 47 and 59 North were studied intensively during multiple occupations by Germany, The Netherlands, UK and USA. Lochte et al. (1992) and Weeks et al. (1992) summarize multinational observations on plankton ecology, chemistry and physics at 47N and 59N, respectively.

NABE investigations took place in a region of the ocean with strong mesoscale eddy structure and horizontal advection. Pingree (1992) describes drogue studies of currents in the study region. Robinson et al. (1992) report an altimetric study which revealed the existence of three anticyclonic eddies and other complex mesoscale and submesoscale variability in the 47N study area (Figure 3). The structure of chlorophyll fields sensed by airborne LIDAR (Yoder et al., 1992; Hoge and Swift, 1992) coincided at the same spatial scales as the physical field, indicating intimate causal connections between the mesoscale circulation and biological dynamics of the bloom (Figure 4). Most of the larger scale variability in the chlorophyll field was oriented in the North-South direction, as originally hypothesized. Complex hydrographic structures in the southern part of the NABE study region were observed during the METEOR occupations at 18 North (Podewski et al., 1992).

Perhaps the most important early scientific contribution of NABE is the development and refinement of analytical techniques for CO<sub>2</sub>, and the collection of a large data set on seasonal and spatial trends in surface pCO<sub>2</sub> (Watson et al., 1991). Less than a decade ago, as JGOFS was first being discussed, Brewer (1986) asked, "What controls the variability of CO<sub>2</sub> in the surface ocean?" After NABE, there can be little argument that in temperate seas, this variability is strongly tied to the dynamics of the bloom. Chipman et al (1992; Figure 5) and Goyet and

Brewer (1992) observed that CO<sub>2</sub> was depleted in the upper 150 m at 47N by 2820 [ $\mu$ ]mol m<sup>-2</sup> during the bloom, and point to the importance of specifying small-scale variations in surface CO<sub>2</sub> which can have a large impact on our estimates of air-sea fluxes.

Phytoplankton blooms are driven by an excess of production over consumption and export, leading to accumulations of biogenic material in surface waters. Several papers in this volume report rates of primary production in excess of 80 [ $\mu$ ]mol C m<sup>-2</sup> d<sup>-1</sup> (1000 gC m<sup>-2</sup> d<sup>-1</sup> or ca 3000 [ $\mu$ ] mol m<sup>-2</sup> over 36 d; Figure 6), a figure agreeing well with the direct observations of CO<sub>2</sub> depletion reported by Goyet and Brewer. Chipman et al (1992) also show that <sup>14</sup>C estimates of primary production in bottles were consistent with direct observations of CO<sub>2</sub> depletion in the mixed layer (Figure 7). Martin et al. (1992) report on determinations of trace metal contamination in productivity bottles used by NABE investigators. Their findings, in conjunction with the comparisons just described, suggest that when performed carefully using moderate clean technique, the NABE productivity protocols yielded a high-quality data set (Figure 8). Marra and Ho present a 2-dimensional (Z-t) model which represents the triggering of the bloom following restratification at 47N. A related approach stressing the importance of diurnal heating is given in Taylor et al., (1992). Gardner et al. (1992) used a transmissometer to demonstrate both diurnal cycles and a longer term increase in small particle stocks, both of which phenomena were closely tied to bloom dynamics (Figure 9).

High rates of new production during blooms are supported by high concentrations of nitrate supplied during winter mixing. Koeve et al., (1992) observed great spatial variability in nitracline depth at 18 North, where nitrate was already depleted in the surface layer. Although models predict that under bloom conditions up to 70-80% of the total primary production may be supported by nitrate (new production; Fasham et al., 1990), NABE observations generally indicated lower f-ratios of 30-45% (40W: Harrison et al., 1992; 59N: Sambrotto et al., 1992; 47N: Martin et al., 1992). These findings suggest that processes supporting regenerated primary production such as grazing and microbial activity were already proceeding at comparatively rapid rates during the bloom. Determinations of the size distribution of primary (Jochem et al., 1992; Joint et al., 1992) and new (Sambrotto et al., 1992) production indicated that over 50 % of the production was by cells less than 5 [ $\mu$ ]m, which tend to be more closely coupled to regenerative processes than larger cells like diatoms and dinoflagellates.

Studies of heterotrophic plankton ecology and rate processes were an important feature of NABE which confirmed the hypothesis that supplies of regenerated nutrients were abundant during the bloom. As expected, mesozooplankton (largely copepods) contributed just a small portion to the plankton biomass, and grazed only a few per cent of the daily production (Figure 10; Morales et al., 1991; Dam et al., 1992; Harrison et al., 1992). Several papers estimate that the contribution of mesozooplankton fecal pellets to measured vertical export rates, ranged from ca 10-100%. Passow and Peinert (1992) found that viable diatoms made up about

30% of the vertical flux at 33N. Head and Horne (1992) speculate that in future studies, analyses of phaeophorbide pigments in sediment traps might characterize the balance between grazing and diatom autolysis as contributors to the export.

Another key finding of NABE was the unexpected importance of microbial activities during the bloom. Simple models of bloom dynamics postulate a period characterized low grazing and high exports of uningested diatom cells. In contrast, NABE investigators on both sides of the Atlantic observed rapid successions of pigments, phytoplankton (Figure 11) and microzooplankton following the onset of the bloom at tropical to subpolar latitudes (Barlow et al., 1992; Sieracki et al., 1992). Veldhuis et al., (1992) document postbloom summer phytoplankton community structure and dynamics. A large and diverse fauna consisting of nanoflagellates, ciliates and dinoflagellates (Burkill et al., 1992; Verity et al., 1992) consumed up to 100% of the daily production at 41- 47W, and 47-59N. An interesting speculation arising from NABE is that this intense activity by protozoans not only fuels primary production by ammonium and urea excretion, but also drives the vertical flux through predation by mesozooplankton (Weeks et al., 1992). Thus although mesozooplankton herbivory was insignificant, these larger animals may have exerted top-down control on the grazer assemblage and contributed to the vertical flux by repackaging smaller grazers into fecal pellets. Such a scenario may explain the high rates of mesozooplankton respiration discussed by Lenz et al., (1992). Honjo and Manganani (1992) present their observations of fluxes to the deep sea at two NABE stations.

Grazer activity may also have stimulated bacterial production. A bacterial bloom lagging the phytoplankton bloom by 10-20 days was observed at 41-47W and 47-59N (Li et al., 1992; Ducklow et al., 1992). Bacterial production averaged 20-30% of primary production it was unlikely that these levels were supported by exudation from phytoplankton. Grazer-mediated release and particle decay (cf Martin et al., 1992) are logical sources of sustenance for the bacteria. The large pool of dissolved organic carbon (DOC) may also have contributed to bacterial production. Kirchman et al., (1991) observed that bacteria utilized 25% of surface DOC ( $50 \mu\text{mol kg}^{-1}$ ) in experiments conducted at 47N. Lochte et al. (1992) suggest that bacteria using DOC at efficiencies of ca. 20-30% could explain net consumption of  $110 \text{ mMol m}^{-2} \text{ d}^{-1}$  at 47N. Based on NABE measurements of DOC stocks, Peltzer et al (1992) and Martin and Fitzwater (1992) suggest upward revisions of the size of the oceanic DOC reservoir to 1680-1800 Gt. Are bacterioplankton the filter through which DOC produced by plankton in the upper ocean passes into the ocean interior? The processes responsible for forming and cycling the oceanic DOC pool are just beginning to be addressed. NABE continued in 1990 with coordinated studies by the UK, Germany and The Netherlands. Savidge et al., (1992) described the ambitious attempts by BOFS to conduct Lagrangian observations of the bloom in the eddy field between 46 and 50 North. Lagrangian studies of the survival and evolution of microbial communities in Mediterranean outflow eddies ('Meddies') studied by the French JGOFS program are presented by Savenkoff et al., (1992). Pfannkuche (1992) presents time series

observations of the benthic response to organic matter sedimentation at 47 North between 1985-1990.

NABE, the first JGOFS process study and first large-scale multinational study of ocean biogeochemistry, has revealed that the North Atlantic phytoplankton bloom was a complex phenomenon with many unexpected features. Its most surprising attribute was intense nutrient regeneration activity supported by large stocks of microbes, and presumably, high rates of respiration. Yet over the 30-40 day observation period at 47N, CO<sub>2</sub> was depleted from the mixed layer with great efficiency, at about 75% of the rate of primary production. This apparent paradox calls into question the oft-quoted identification of CO<sub>2</sub> drawdown with new production, and requires new models of bloom dynamics for its resolution. The strong connection between the mesoscale physical and biogeochemical fields demonstrate the need for eddy-resolving coupled circulation/biogeochemical models to help understand oceanic blooms.

### Acknowledgments

This article was written in association with the co-editor of the NABE Special Volume, Roger Harris (Plymouth, UK). I am grateful to the authors of papers in that volume for use of their data and figures presented in this report.

### References

- Barlow, R.G., Gough, M.A., Mantoura, R.F.C. and Fileman, T.W. Pigment signatures of the phytoplankton composition in the North Eastern Atlantic during the 1990 spring bloom. *Deep-Sea Res.* (Special NABE Volume, in press).
- Bender, M. L., H. W. Ducklow, J. Kiddon, J. Marra, and J. H. Martin, 1992, The carbon balance during the 1989 spring bloom in the North Atlantic ocean, 47N, 20W. *Deep-Sea Res.* (in press).
- Billet, D. S. M., R. S. Lampitt, A. L. Rice, and R. F. C. Mantoura, 1983, Seasonal sedimentation of phytoplankton to the deep-sea benthos, *Nature* 302: 520-22.
- Brewer, P. G., 1986, What controls the variability of carbon dioxide in the surface ocean? A plea for complete information. In: "Dynamic Processes in the Chemistry of the upper ocean" J. D. Burton., P. G. Brewer and R. Chesselet eds. Plenum Press, pp. 215-231.
- Burkill, P.H., Edwards, E.S., John, A.W.J. and Sleigh, M.A. Microzooplankton and their herbivorous activity in the north eastern Atlantic Ocean. *Deep-Sea Res.* (Special NABE Volume, in press).

- Chipman, D. W., J. Marra and T. Takahashi, 1992. Primary production at 47N, 20W in the North Atlantic Ocean: A comparison between the <sup>14</sup>C incubation method and mixed layer carbon budget observations. *Deep-Sea Res.* (Special NABE Volume, in press).
- Colebrook, J. M., 1982, Continuous Plankton Records: Seasonal Variations In The Distribution And Abundance Of Plankton In The North Atlantic Ocean And The North Sea, *J. Plankton Res.* 4:435-462.
- Dam, H. G, C. A. Miller and S. H. Jonasdottir, 1992. The trophic role of mesozooplankton at 47N, 20W during the North Atlantic Bloom Experiment. *Deep-Sea Res.* (Special NABE Volume, in press).
- Ducklow, H. W., D.L. Kirchman, H.L. Quinby, C.A. Carlson and H.G. Dam, Bacterioplankton carbon cycling during the spring bloom in the eastern North Atlantic Ocean." *Deep-Sea Res.* (Special NABE Volume, in press).
- Ducklow, H. W. 1989, Joint Global Ocean Flux Experiment: The North Atlantic Spring Bloom Experiment, 1989, *Oceanography Magazine*, 2:4-8.
- Esaias, W. E., G. C. Feldman, C. R. McClain, and J. A. Elrod. 1986. Monthly satellite-derived phytoplankton pigment distribution for the North Atlantic Ocean basin. *EOS*, 835-837.
- Fasham, M. J. R., J. L. Sarmiento, R. D. Slater, H.W.Ducklow and R. Williams, 1992, A seasonal three-dimensional ecosystem model of nitrogen cycling in the North Atlantic euphotic zone: A comparison of the model results with observations from Bermuda Station "S" and OWS "India." *J. Geophys. Res.*, (submitted).
- Gardner, W. D., I. D. Walsh and M. J. Richardson, 1992. Biophysical forcing of particle distributions during the North Atlantic Bloom Experiment. *Deep-Sea Res.* (Special NABE Volume, in press).
- Glover, D. M. and P. G. Brewer, 1988, Estimates of wintertime mixed layer nutrient concentrations in the North Atlantic. *Deep-Sea Res.* 35:1525-1546.
- Goyet, C., and P. G. Brewer, 1992. Temporal variations of the properties of the carbonate system in the North Atlantic Ocean at 47N, 20W: The CO<sub>2</sub> flux across the air-sea interface. *Deep-Sea Res.* (Special NABE Volume, in press).
- Gran, H. H. and T. Braarud, 1935, A quantitative study of the phytoplankton in the Bay of Fundy and the Gulf of Maine including observations on the hydrography, chemistry and turbidity. *J. Biol. Bd. Canada* 1:219-467.
- Harrison, W. G., E. J. H. Head, E. P. W. Horne, B. Irwin, W. K. W. Li, A. R. Longhurst, M. Paranjape, and T. Platt, 1992. The Western North Atlantic

- Bloom Experiment. *Deep-Sea Res.* (Special NABE Volume, in press).
- Head, E. J. H. and E. P. W. Horne, 1992. Algal Pigment transformation and Vertical Flux in an area of convergence in the North Atlantic. *Deep-Sea Res.* (Special NABE Volume, in press).
- Hoge, F. E., and R. N. Swift, 1992. The influence of chlorophyll pigment upon upwelling spectral radiances from the North Atlantic Ocean: An active-passive correlation spectroscopy study. *Deep-Sea Res.* (Special NABE Volume, in press).
- Honjo, S. and S. J. Manganini, 1992. Annual biogenic particle fluxes to the interior of the North Atlantic Ocean studied at 34N 21W and 48N, 21W. *Deep-Sea Res.* (Special NABE Volume, in press).
- Jochem, F.J. and Zeitzschel, B. Productivity regime and phytoplankton size S structure in the tropical and subtropical North Atlantic in spring 1989. *Deep-Sea Res.* (Special NABE Volume, in press).
- Joint, I.R., Pomroy, A., Savidge, G. and Boyd, P. Size fractionated primary productivity in the North East Atlantic in Spring 1989. *Deep-Sea Res.* (Special NABE Volume, in press). *Deep-Sea Res.* (Special NABE Volume, in press).
- Kirchman, D. L., Y. Suzuki, C. Garside and H. W. Ducklow. 1991. High turnover rates of dissolved organic carbon during a spring phytoplankton bloom. *Nature* 352:612-614.
- Koeve, W., Eppley, R.W., Podewski, S. and Zeitzschel, B. An unexpected nitrate distribution in the tropical North Atlantic at 18N, 30W - implication for new production. *Deep-Sea Res.* (Special NABE Volume, in press).
- Lenz, J., Morales, A. and Gunkel, J. Mesozooplankton standing stock during the North Atlantic spring bloom study in 18/9/91. *Deep-Sea Res.* (Special NABE Volume, in press).
- Li, W. K. W., P.M. Dickie, W. G. Harrison and B. D. Irwin, 1992. Biomass and production of bacteria and phytoplankton during the spring bloom in the western North Atlantic Ocean. *Deep-Sea Res.* (Special NABE Volume, in press).
- Lochte, K., Ducklow, H.W., Fasham, M.J.R. and Stienen, C. Plankton succession and carbon cycling at 47N/20W during the JGOFS North Atlantic bloom experiment. *Deep-Sea Res.* (Special NABE Volume, in press).
- Marra, J. and C. Ho, 1992. Initiation of the Spring Bloom in the North Atlantic (47N/20W): A Numerical Simulation. *Deep-Sea Res.* (Special NABE Volume, in press).

- Martin, J. H., and S. E. , 1992, Dissolved organic carbon in the Atlantic, Southern and Pacific Oceans. *Nature* (submitted).
- Martin, J. H., S. E. Fitzwater, R. M. Gordon, C. N. Hunter and S. J. Tanner, 1992. Iron, primary production and flux studies during the JGOFS North Atlantic Bloom Experiment. *Deep-Sea Res.* (Special NABE Volume, in press).
- Mills, E. L. 1989, Biological Oceanography, An Early History, 1870-1960. Ithaca: 378 p.
- Morales, C. E., A. Bedo, R. P. Harris, and P. R. G. Tranter, 1991, Grazing of copepod assemblages in the north-east Atlantic : the importance of the small size fraction. *J. Plankton Res.* 13:455-472.
- Passow, U. and R. Peinert, 1992. The role of plankton in particle flux: two case studies from the North Atlantic. *Deep-Sea Res.* (Special NABE Volume, in press).
- Peltzer, E. T., P. G. Brewer, Y. Suzuki and Y. Sugimura, 1992, Measurement of dissolved organic carbon in seawater by high temperature catalytic oxidation. *J. Mar. Res.* (submitted).
- Pfannkuche, O. Benthic response to the sedimentation of particulate organic matter at the BIOTRANS station 47N/20W. *Deep-Sea Res.* (Special NABE Volume, in press).
- Pingree, R.D. Flow of surface waters to the west of the British Isles and in the Bay of Biscay. *Deep-Sea Res.* (Special NABE Volume, in press).
- Platt, T., D. F. Bird and S. Sathyendranath, 1991, Critical depth and marine primary production. *Proc. Royal Soc. London B264*:205- 217.
- Podewski, S., Saure, G., Eppley, R.W., Koeve, W., Peinert, R. and Zeitschel, B. The nose: a characteristic inversion within the salinity maximum water in the tropical North-East Atlantic. *Deep-Sea Res.* (Special NABE Volume, in press).
- Riley, G. A. 1942. The relationship of vertical turbulence and spring diatom flowerings. *J. Mar. Res.* 5:67-87.
- Robinson, A. R., D. J. McGillicuddy and 10 others, 1992. Mesoscale and upper ocean variability during the 1989 JGOFS Bloom Study. *Deep-Sea Res.* (Special NABE Volume, in press).
- Sambrotto, R. N., J. H. Martin, W. W. Broenkow, C. A. Carlson and S.E. Fitzwater, 1992. Nitrate utilization in surface waters of the Iceland Basin during Spring and Summer of 1989. *Deep-Sea Res.* (Special NABE Volume, in press).



- Savenkoff, C., Lefevre, D., Denis, M. and Lambert, C.E. How do microbial communities keep living in the Mediterranean outflow within N.E. Atlantic intermediate waters?
- Savidge, G., Turner, D.R., Burkill, P.H., Watson, A.J., Angel, M.V., Pingree, R.D., Leach, H. and Richards, K.J. The BOFS 1990 spring bloom experiment: temporal evolution and spatial variability of the hydrographic field. *Deep-Sea Res.* (Special NABE Volume, in press).
- Sieracki, M. E., P. G. Verity and D. K. Stoecker, 1992. Plankton community response to sequential silicate and nitrate depletion during the 1989 North Atlantic Spring Bloom *Deep-Sea Res.* (Special NABE Volume, in press).
- Sverdrup, H. U., 1953, On the conditions for the vernal blooming of phytoplankton, *J. Cons. Perm. Int. Explor. Mer.*, 18:287-295.
- Taylor, A.H. and Stephens, J.A. Diurnal variations of convective mixing and the spring bloom of phytoplankton. *Deep-Sea Res.* (Special NABE Volume, in press).
- U.S. Global Ocean Flux Study Office, 1989, Ocean Color From Space, A folio of Coastal Zone Color Scanner imagery. WHOI: Woods Hole, MA.
- Veldhuis, M.J.W., Kraay, G.W. and Gieskes, W.C. Growth and fluorescence characteristics of ultraplankton on a North-South transect in the eastern North Atlantic. *Deep-Sea Res.* (Special NABE Volume, in press).
- Verity, P. G., D. K. Stoecker, M. E. Sieracki, P. H. Burkill, E. S. Edwards, and C. R. Tronzo, 1992. Abundance, biomass, and distribution of heterotrophic dinoflagellates during the North Atlantic Spring Bloom. *Deep-Sea Res.* (Special NABE Volume, in press).
- Watson, A. J., C. Robinson, J. E. Robertson, P. J. LeB. Williams and M. J. R. Fasham, 1991, Spatial variability in the sink for atmospheric carbon dioxide in the North Atlantic. *Nature* 350: 50-53.
- Watson, A. J. and M. Whitfield 1985). Composition of particles in the global ocean. *Deep-Sea Res.* 32:1023-1039.
- Weeks, A., and 13 others, 1992. The physical and chemical environment and changes in community structure associated with bloom evolution: the JGOFS North Atlantic Bloom Experiment. *Deep-Sea Res.* (Special NABE Volume, in press).
- Yoder, J. A., J. Aiken, R. N. Swift, F. E. Hoge, and P.M. Stegemann, 1992. Spatial variability in near-surface chlorophyll a fluorescence measured by the air-

borne oceanographic LIDAR (AOL). *Deep-Sea Res.* (Special NABE Volume, in press).

**Table 1. JGOFS North Atlantic Bloom Experiment.  
Operations at main stations in 1989.**

Station	Dates	Nations	Deep Traps	Other
18N, 31W	23.8 - 8.4	FRG	—	drifting traps
33N, 20W	13.4 - 25.4	FRG	USA	drifting traps
	30.8 - 7.9	NL		NASA overflight
40N, 47W	27.4 - 4.5	CAN	—	drifting traps
45N, 41W	8.5 - 13.5	CAN	—	drifting traps
47N, 20W	24.4 - 9.5	USA	FRG, NL	drifting traps
	5.5 - 24.5	FRG	UK, USA	NASA overflights
	11.5 - 18.5	UK		Geosat altimetry
	18.5 - 31.5	USA		
	1.7 - 8.7	UK		
	16.7 - 26.7	UK		
	10.8 - 25.8	FRG		
	22.8 - 25.8	NL		
59N, 20W	19.4 - 20.4	USA	UK, FRG	drifting traps
	25.5 - 5.6	UK		NASA overflights
	26.5 - 10.6	FRG		ONR MLML mooring
	6.6 - 7.6	USA		
	14.6 - 21.6	UK		
	30.6 - 5.7	USA		
	19.7 - 8.8	FRG		
	3.8 - 10.8	UK		
5.8 - 17.8	NL			
72N, 8W	16.6 - 10.7	FRG	FRG	drifting traps

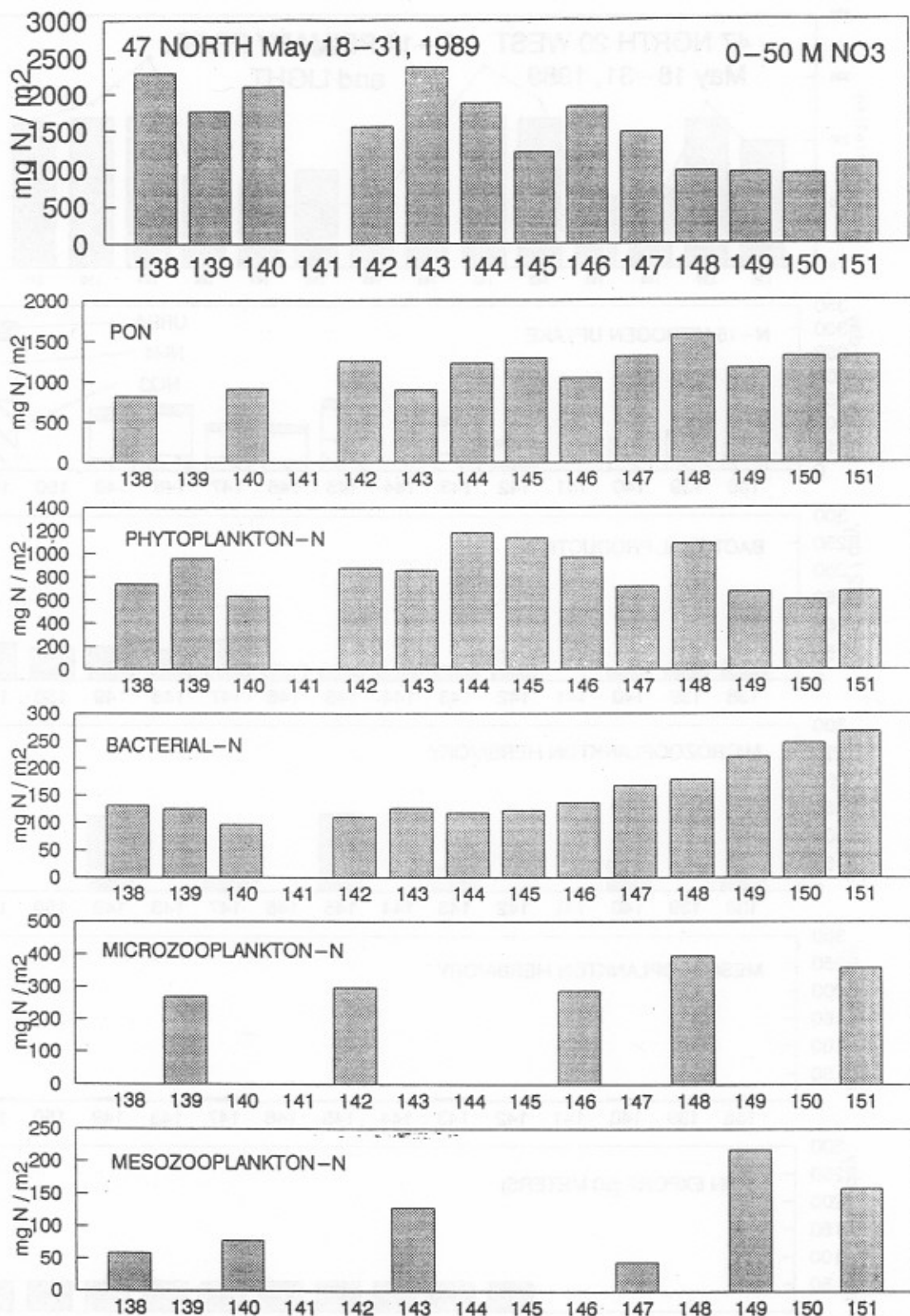
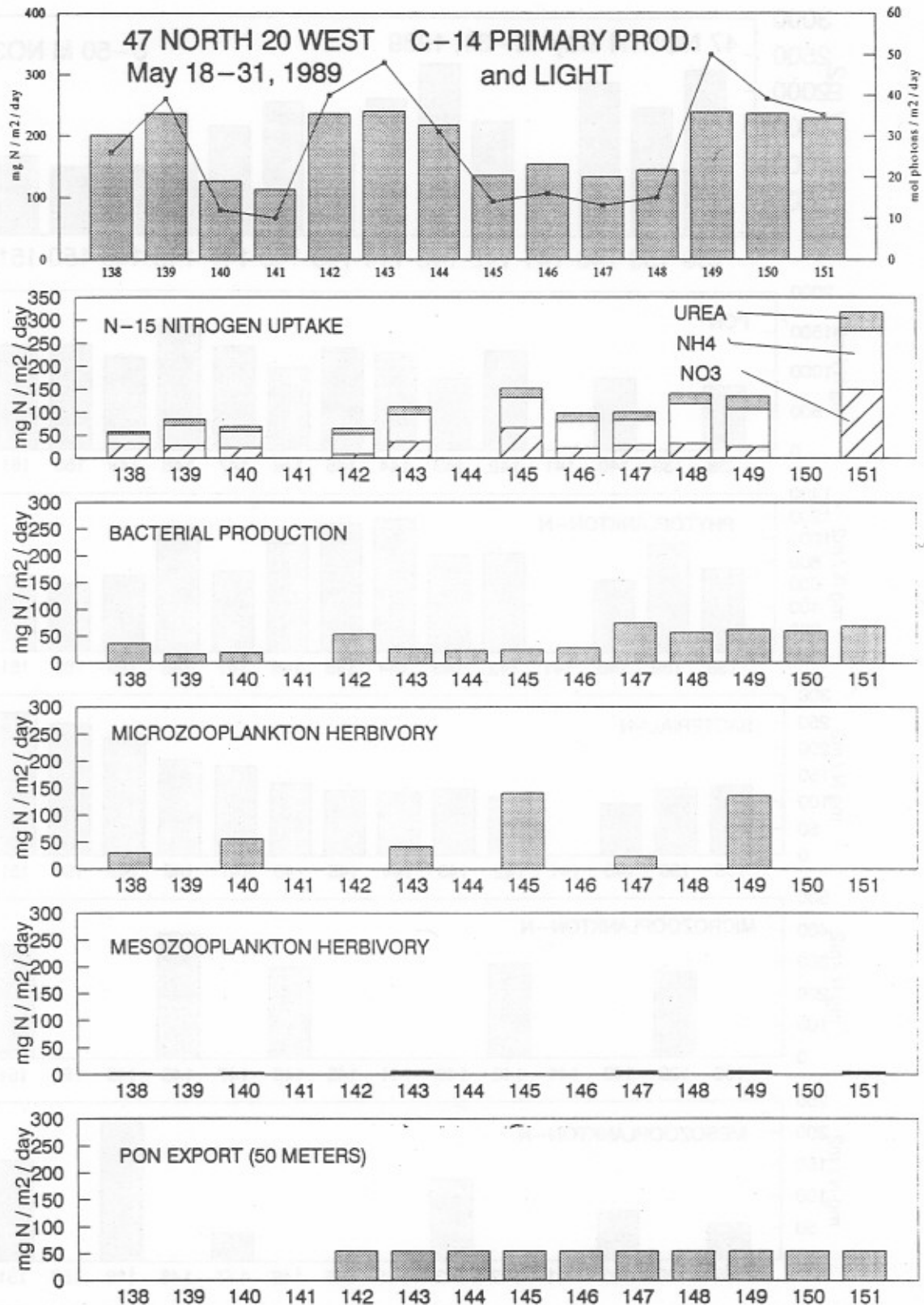

Figure 1. Data collected during the USA cruise at 47 North, May 18-31, 1989, courtesy of R. Williams, Scripps (NO<sub>3</sub>); H. Ducklow, HPEL (PON, bacteria); D. Repeta, WHOI (phytoplankton); H. Dam, HPEL (mesozooplankton); P. Verity, Skidaway (microzooplankton); J. Martin, Moss Landing (primary production and export); and J. McCarthy (N-15 uptake).



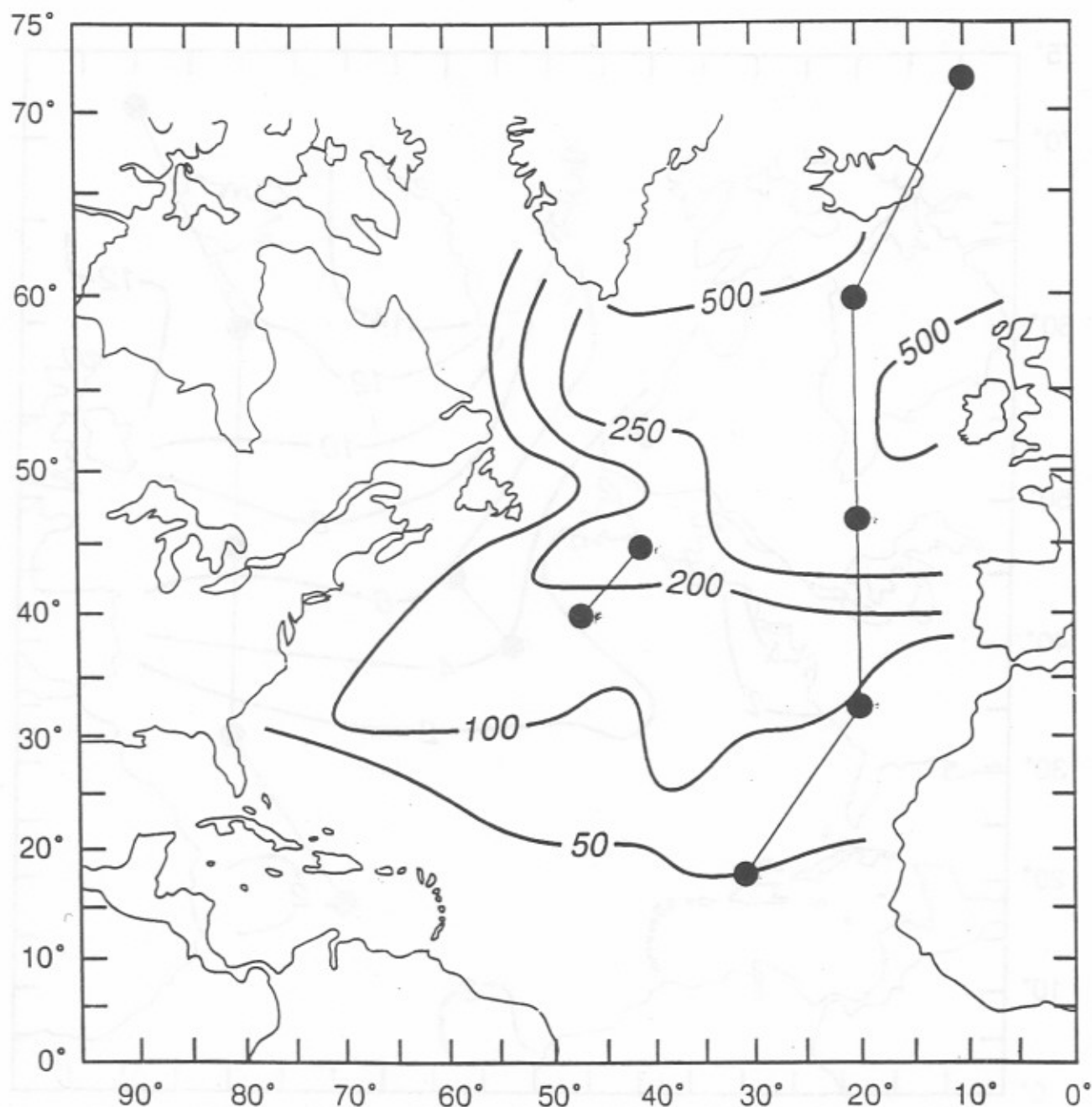
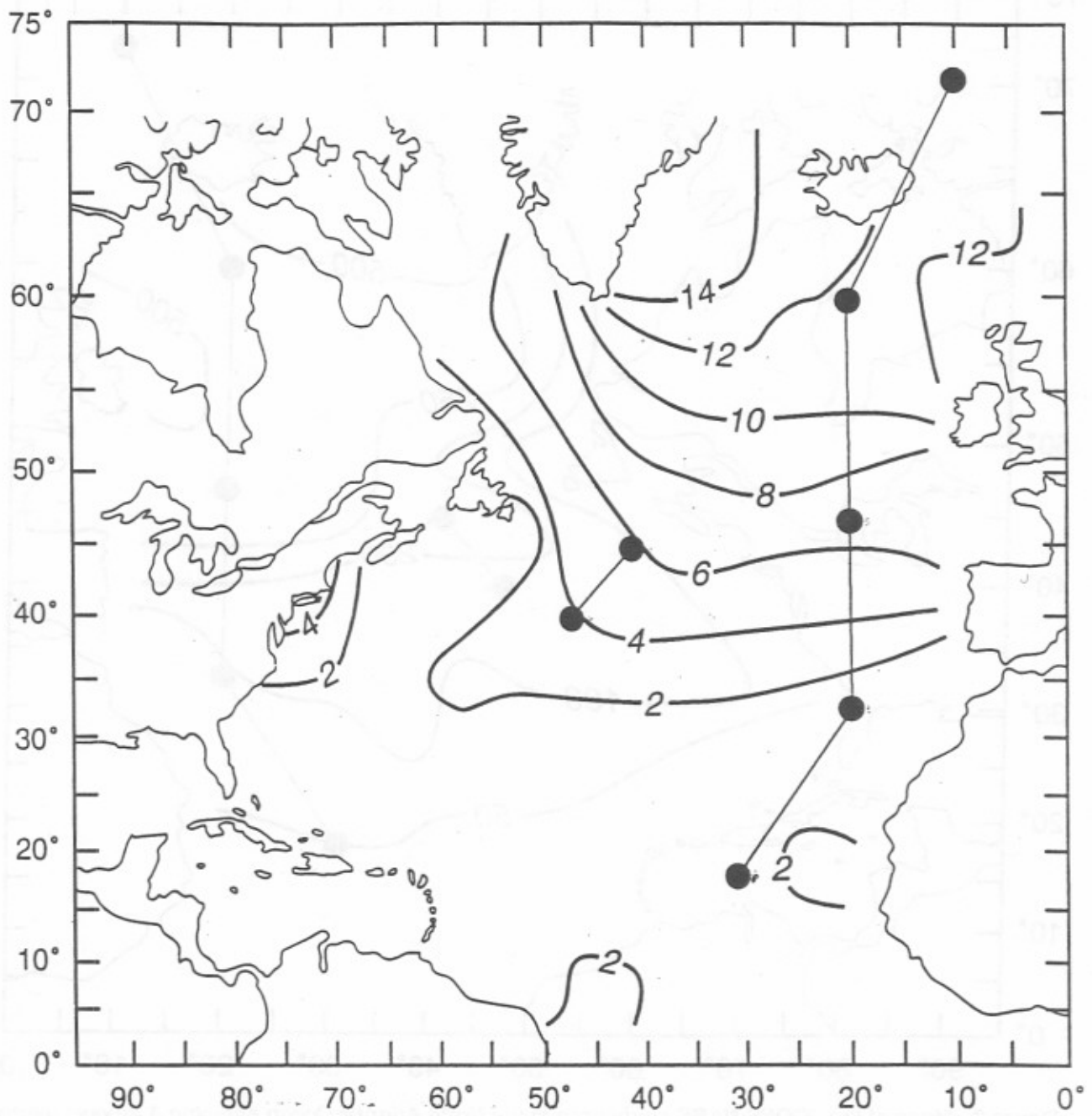

Figure 2. Maps of the JGOFS-NABE study area in the North Atlantic Ocean showing A (above: winter mixed layer depths based on the depth of a  $\sigma_t$  0.125 units greater than the surface value. B (next page: estimated winter maximum surface nitrate concentrations ( $\mu\text{mol l}^{-1}$ ). Contour lines after Glover and Brewer (1987). The principal NABE stations are also indicated.



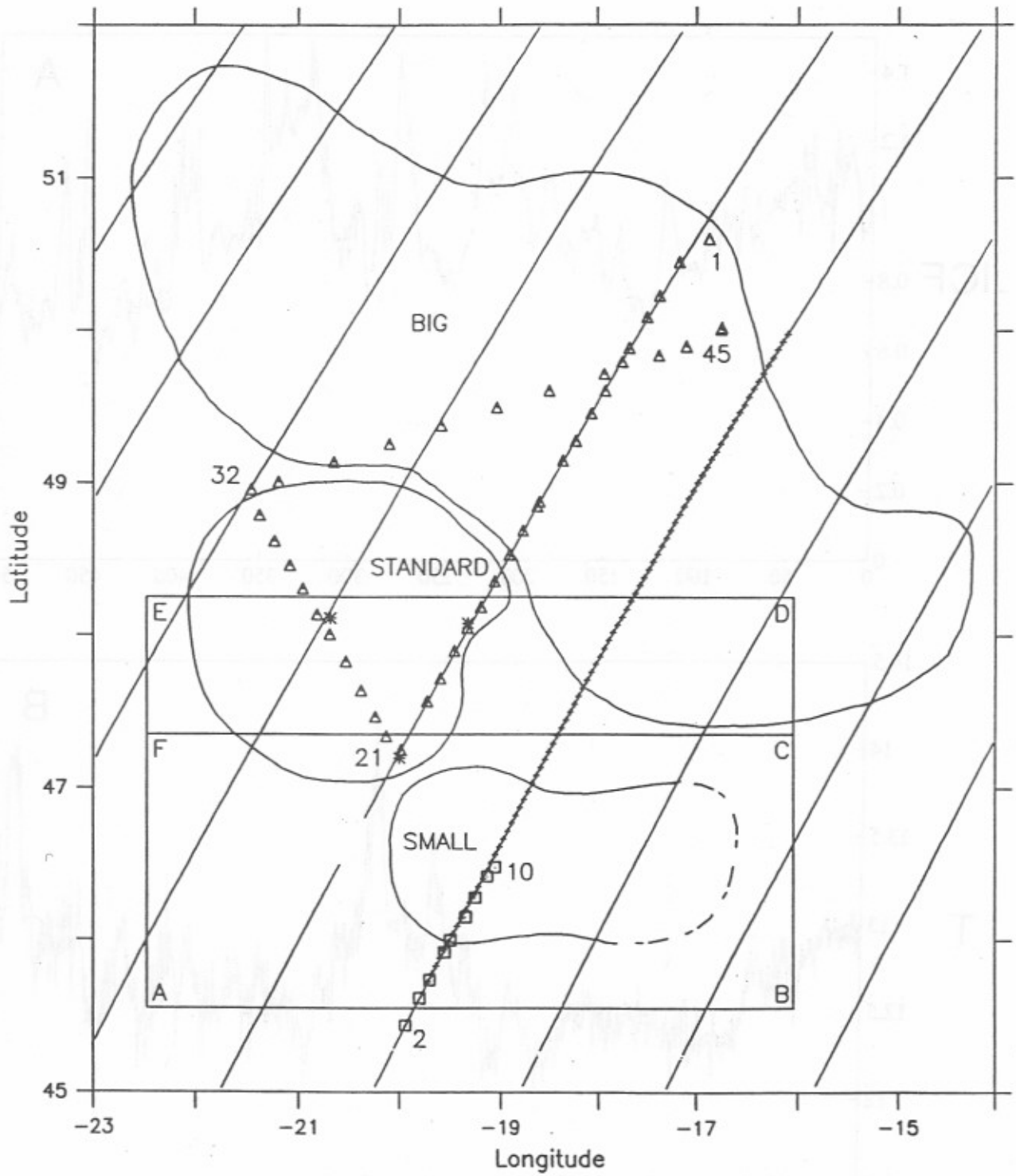

Figure 3. Map of mesoscale eddy field deduced from Geosat altimetric observations (Robinson et al., 1992).

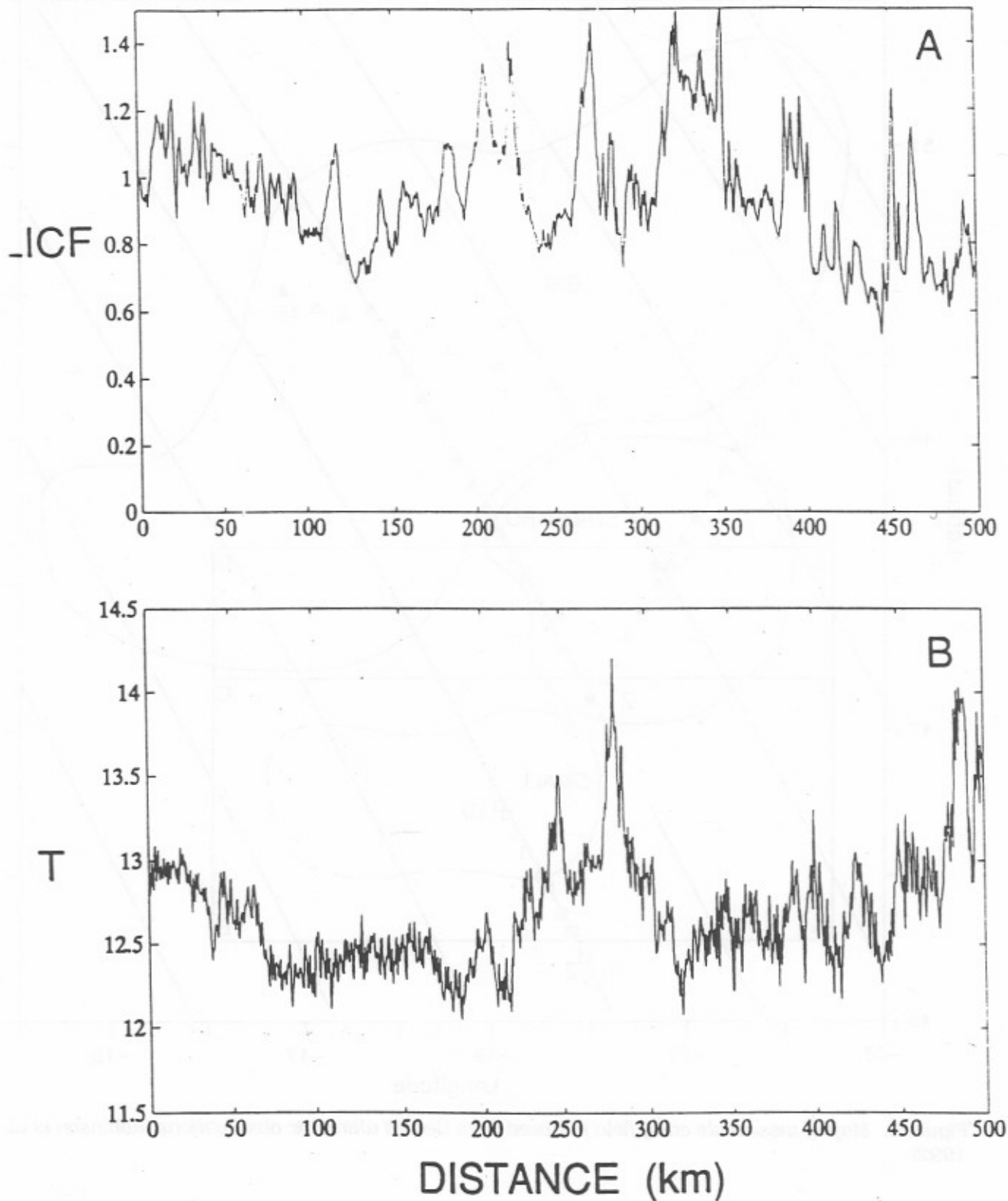

Figure 4. Alongtrack temperature and lidar-induced chlorophyll-fluorescence (LICF) in the JGOFS study area (Yoder et al., 1992).



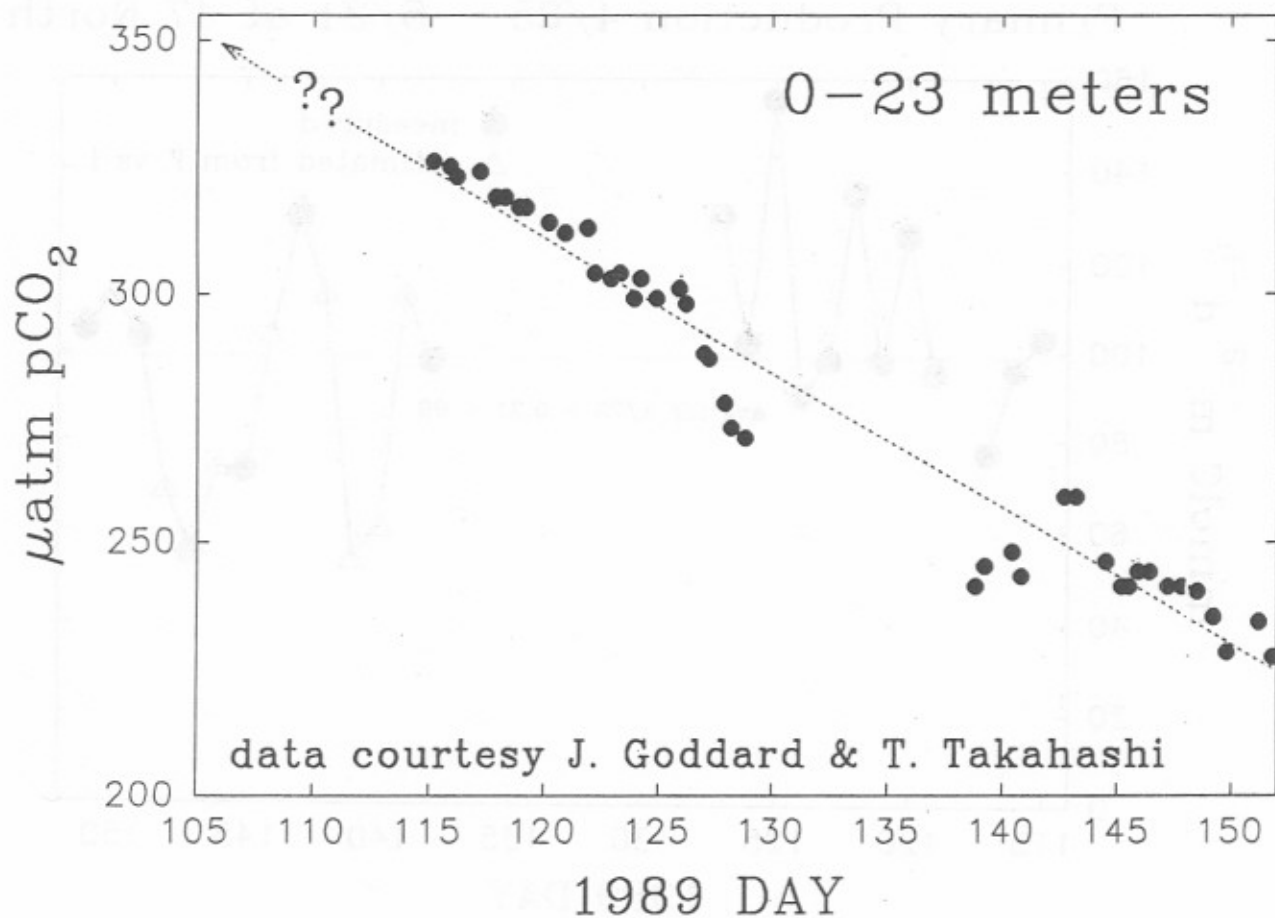

Figure 5. Drawdown of pCO<sub>2</sub> at 47 North, April 25 - May 31, 1989, drawn from data provided by T. Takahashi, J. Goddard and D. Chipman (Lamont-Doherty).

## Primary Production 4/25 - 5/31 at 47 North

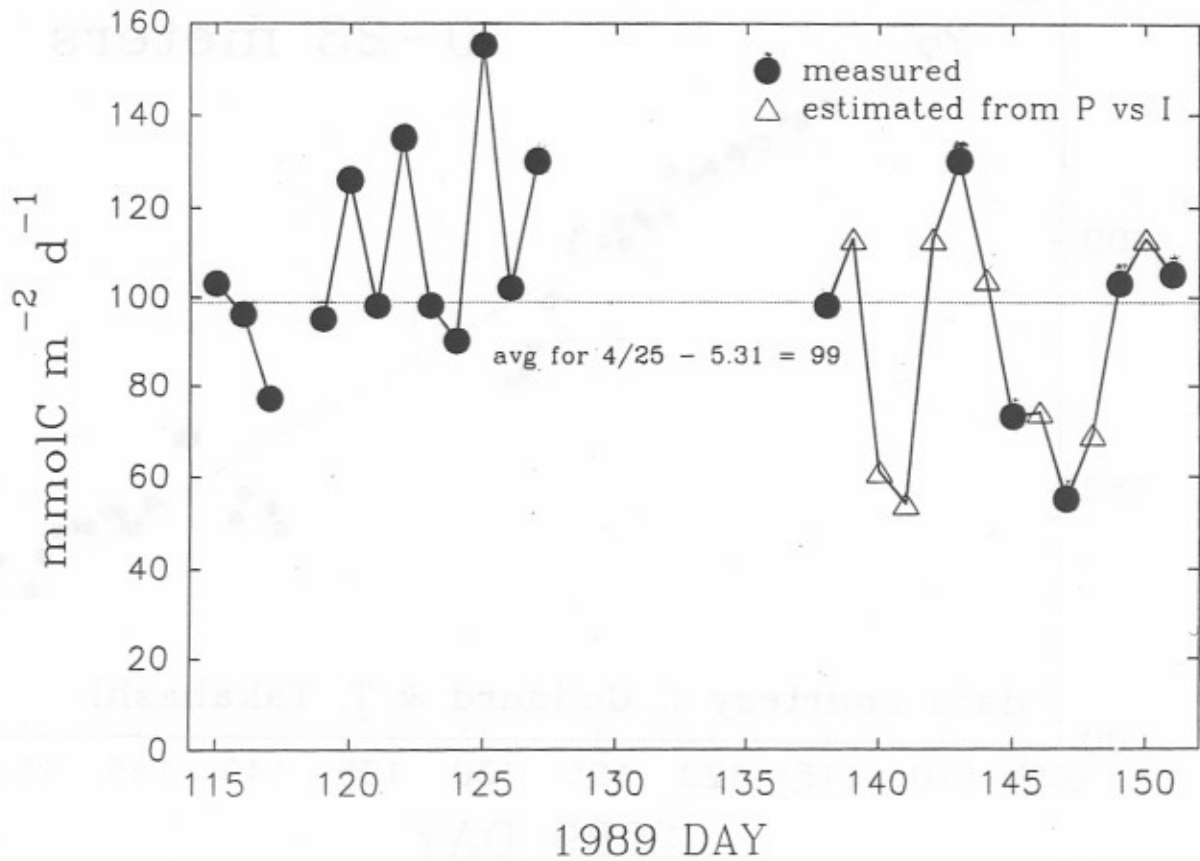

Figure 6. Primary production rates at 47 North, courtesy J. Marra (Lamont) and J. Martin (Moss Landing).

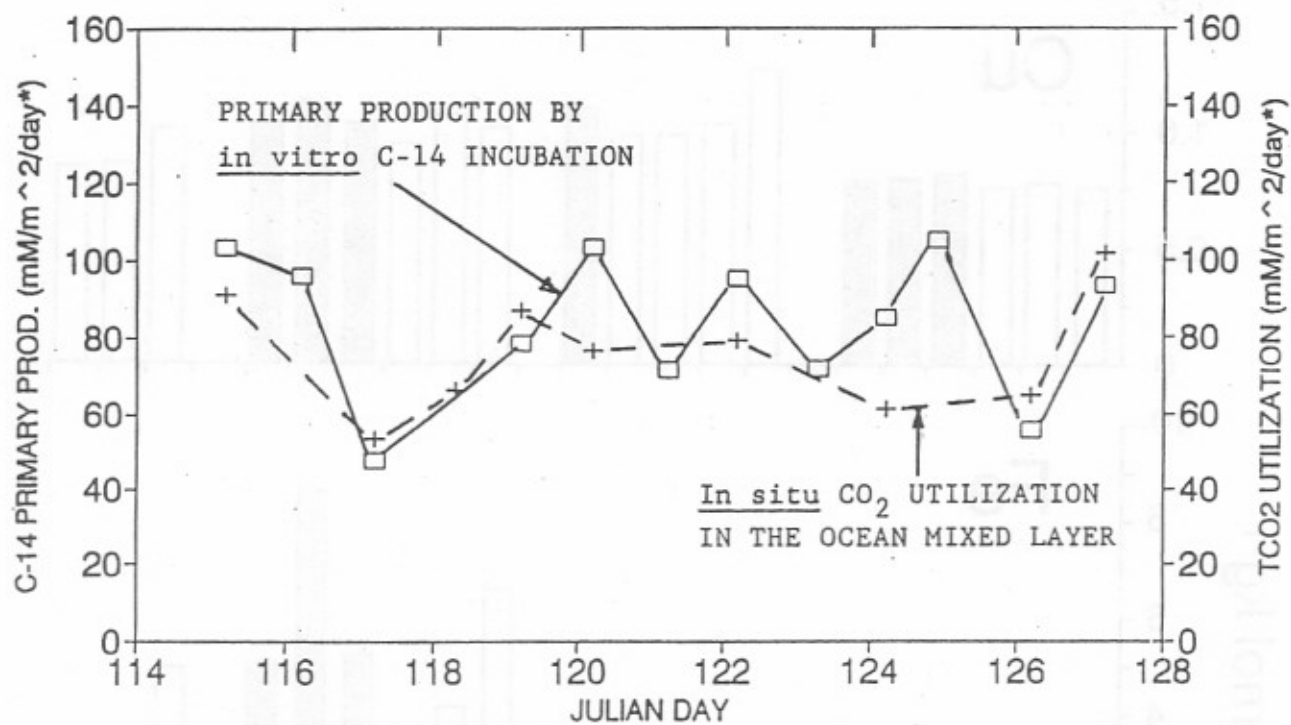

Figure 7. Comparison of primary production estimates from *in situ* C14 incubations and observed CO<sub>2</sub> drawdown in the mixed layer at 47 North, April 25 - May 8, 1989 (Chipman et al., 1992).

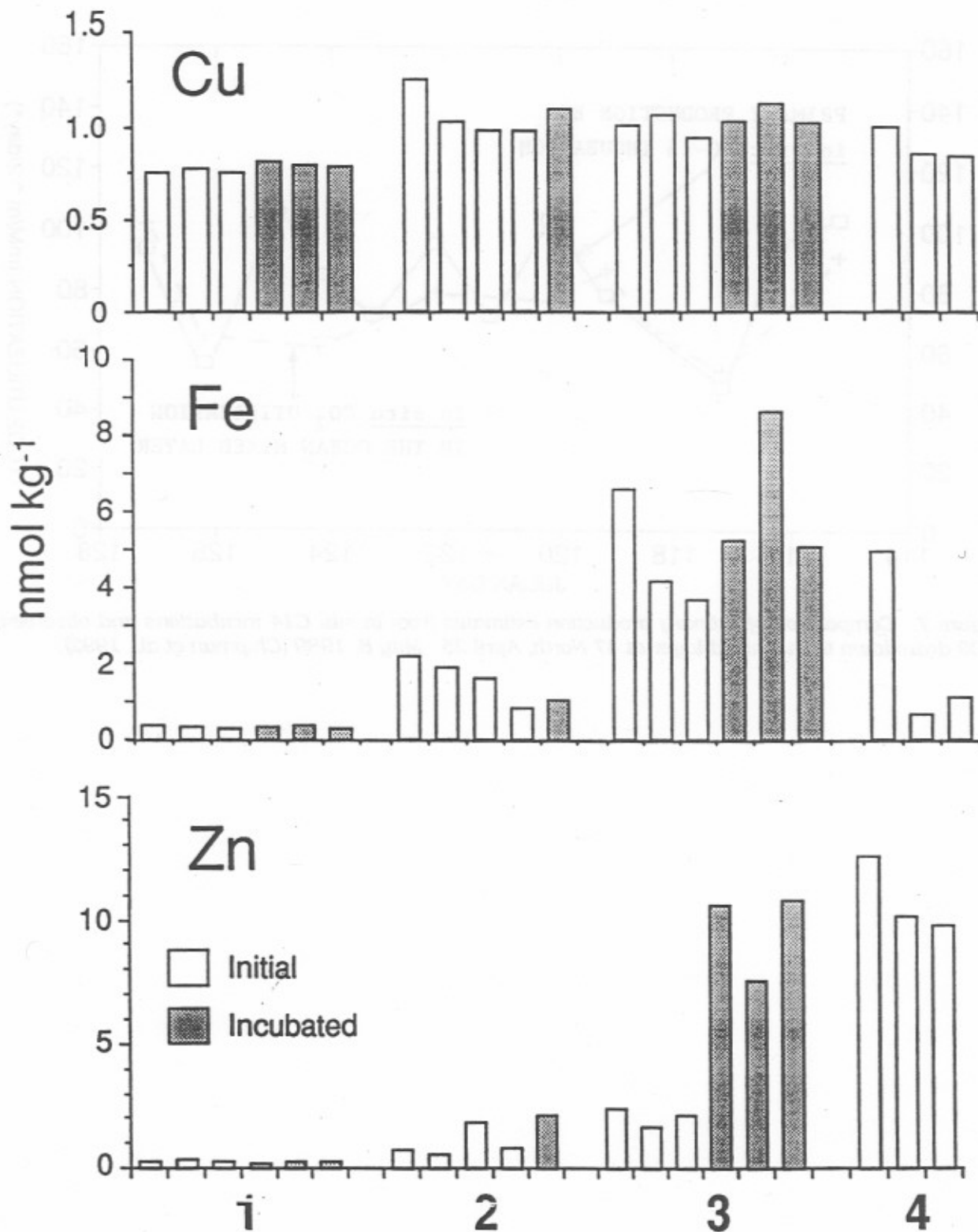

Figure 8. Concentration of trace metal contaminants in water samples (open boxes) and primary production incubations (shaded boxes) by different NABE nations (numbers) in 1989. All levels except perhaps Zn in some incubations are below toxic concentration (Martin et al., 1992).

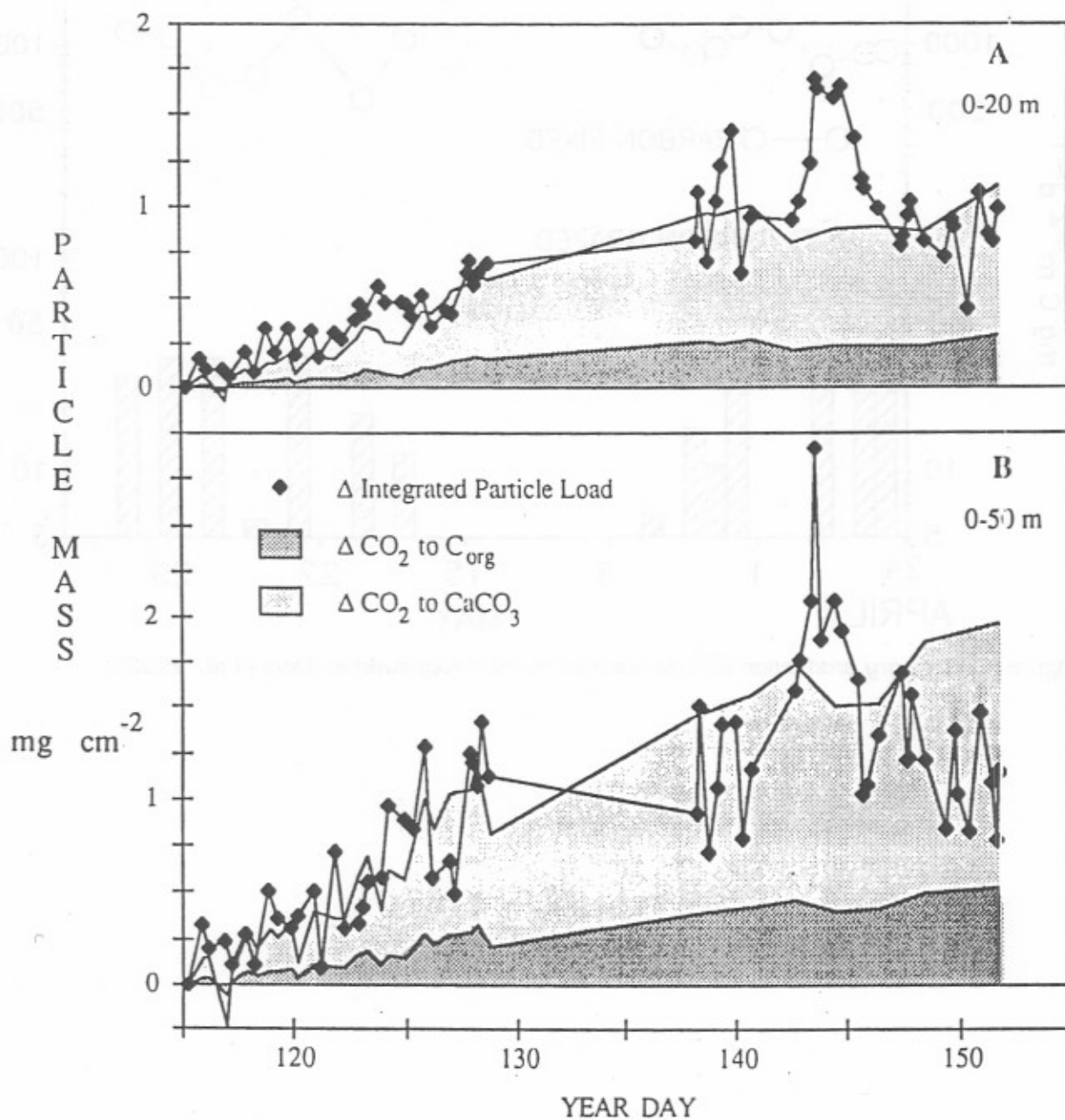

Figure 9. Comparison of changes in particle concentration from transmissometry and CO<sub>2</sub> utilization at 47 North (Gardner et al., 1992).

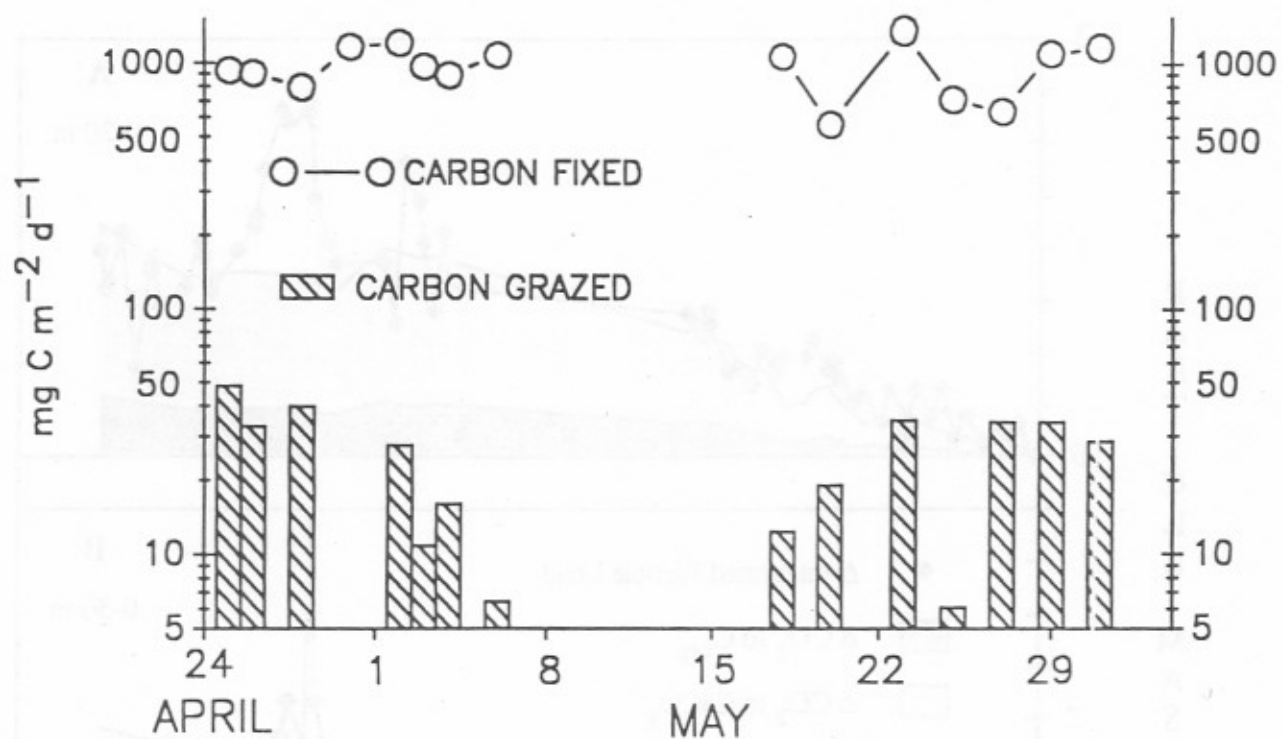

Figure 10. Primary production and its removal by mesozooplankton (Dam et al., 1992).

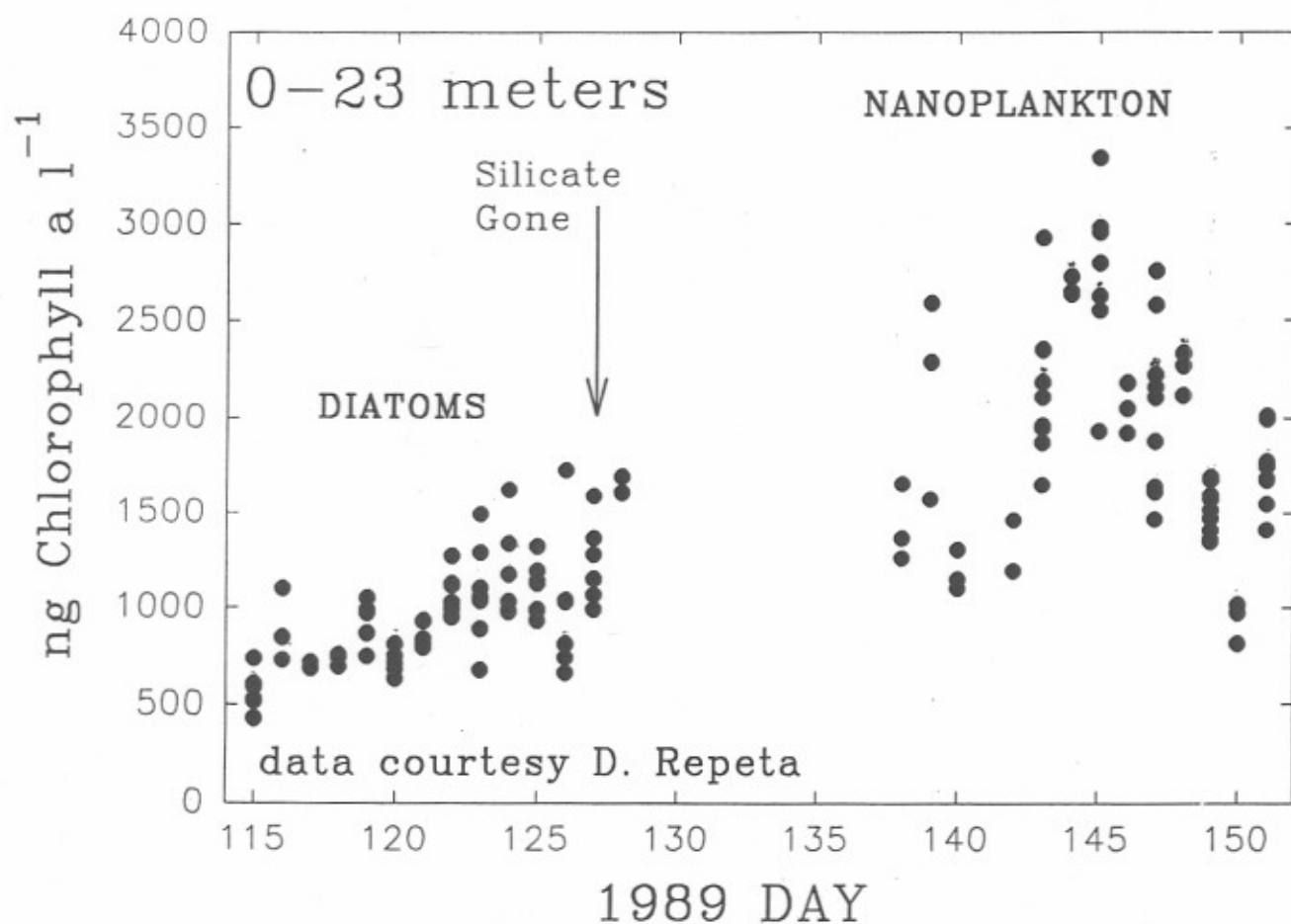

Figure 11. Succession of phytoplankton groups at 47 North. Data after D. Repeta (WHOI), following interpretation of J. Marra (Lamont) and M. Sieracki (Bigelow Lab.).

## **Data Management for JGOFS: Theory and Design**

---

***Glenn R. Flierl, James K.B. Bishop, David M. Glover,  
Satish Paranjpe***

### **Introduction**

The Joint Global Ocean Flux Study (JGOFS), currently being organized under the auspices of the Scientific Committee for Ocean Research (SCOR), is intended to be a decade long internationally coordinated program. The main goal of JGOFS is to determine and understand on a global scale the processes controlling the time-varying fluxes of carbon and associated biogenic elements in the ocean and to evaluate the related exchanges with the atmosphere, sea floor and continental boundaries." "A long-term goal of JGOFS will be to establish strategies for observing, on long time scales, changes in ocean biogeochemical cycles in relation to climate change." Participation from a large number of U.S. and foreign institutions is expected. JGOFS investigators have begun a set of time-series measurements and global surveys of a wide variety of biological, chemical and physical quantities, detailed process-oriented studies, satellite observations of ocean color and wind stress and modeling of the bio-geochemical processes. These experiments will generate data in amounts unprecedented in the biological and chemical communities; rapid and effortless exchange of these data will be important to the success of JGOFS.

Microcomputers and workstations have dramatically altered the gathering and analysis of oceanic data. While the convenience and ease of use of these machines make them ideal for an individual working on his or her data, the process of exchanging data or collecting relevant information from archived data sets is still difficult and daunting. Everyone uses different formats with different procedures for manipulating data; there is relatively little chemical and biological data available in the archives at NODC and it must be ordered in batch and arrives on a magnetic tape. We believe that this difficulty can be overcome—it should be possible for the user of a small computer connected to a network to be able to locate and work with data at NODC or indeed anywhere in a distributed data base without regards to its location or format.

Envision being able to sit at a microcomputer and ask what sets of phosphate data are available and then, based on the reply, ask for some suitable subset. The data could be imported to your local storage where it would arrive in the format you are accustomed to using for your own data or it could be used directly for creating a plot or as part of a calculation. Essentially, the JGOFS distributed data archive, as well as large amounts of historical data, would appear to be an extension of one's own data base—as readily available and as familiar in struc-



ture. The user would not need to know where the data is physically located nor how it is actually stored. We believe that the synthesis of the data from large experiments can only be accomplished when this kind of data exchange can occur (see Codd, 1990 for a discussion of the advantages and disadvantages of distributed database management).

## **Approach**

Our approach to data management has been to construct a system in which the data (ideally) is not gathered into a central archive but rather resides at the originator's site and represents the PI's current best version of the data set. The storage format is likewise the PI's choice. Others can access the data without regard to storage method or location.

We are faced with requirements to manage and integrate extremely diverse sets of data. At the same time, many of the potential JGOFS PI's do not have extensive experience with large computers and data bases. With the rapidly growing capabilities of microcomputers and greatly reduced cost of workstations, however, we expect that most data gathering and preliminary analysis will be done on such machines. Based on these considerations we have built our JGOFS data system to satisfy two primary requirements: 1) A simple, usable, and flexible data base for micros/ workstations which can be used for data management of an individual PI's data sets and those which he or she collects from other investigators and archives. 2) Straightforward (or if possible even transparent) linkage to data sets on networked (SUN, VAX ... Cray) machines. Many data base programs exist for small machines and, in and of itself, there is little value in developing another one. Rather, we have begun building an "object-oriented" (to be defined in more detail below) data base which has many unique features making it especially suitable for experiments such as JGOFS and WOCE. For the new initiatives on Global Change, data management will likewise be of fundamental importance (Natl. Acad. Sci., 1991). Systems such as ours provide the flexibility to handle such widely diverse data sets from many different sites and to integrate the information into useful form.

## **Object-Oriented Data Bases**

The basic element of the so-called "object oriented" programming languages and systems is an "object" which is a combination of data and programs capable of manipulating both the internal data and information passed from outside (Fig. 1). (We summarize the unfamiliar terms in Table 1 for reference.) The user does not deal directly with the internal information (and is therefore shielded from the complexities of its storage and format) but instead communicates with the program part of the object by passing it "messages" which cause it to calculate the appropriate response and return a message to the inquirer. Thus, the details of the manipulations are also generally hidden from the user; rather each object can receive a documented set of messages to which it responds with a documented set

of replies. We shall call the program part of the object the "method" (this terminology is a little simplified over that of object oriented languages such as SMALLTALK).

Object-oriented languages are gaining popularity because their modular structure allows building complex programs from simpler, individually tested components. Refer to Meyer (1988) and Date (1990) for discussions of this type of language. A more recent review, by Wegner (1990) describes detailed distinctions between conventional systems and those built using "object-based" or "object oriented" techniques for structuring. The inherent modularity of object-oriented programming allows for rapid testing of new ideas and easy changes, since usually only one object is involved and the other objects which have been combined to perform some operation can proceed unchanged (Waldrop, 1987).

---

### Table 1 Definitions

**object:** a combination of data and program into an entity which interfaces with user programs.

**message:** information passed between user programs and objects or between various objects.

**method:** the program part of an object. Receives messages messages the relevant data sets and returns messages with the appropriate answers.

**dictionary:** a table connecting the name of an object with the data file and the method which make up the object.

**constructed object:** an entity which appears to be an object to user programs but which actually has no data set directly associated with it; instead the method for the constructed object requests information from other methods and manipulates the data in the replies to generate the data necessary to respond to the requests from the user.

**server:** the program responsible for channeling messages to the proper methods. It will also deal with the connections to networks and talk with servers on the other machines.

**relational data base (RDB):** a data base which deals with data sets organized as tables. Relations among various data sets are based on commonality of information in one or more columns of each of the data sets. E.g., two separate tables could represent the results of different investigators' processing of data from water samples; the data sets would be inter-related using the commonality of cast and bottle numbers.

**inventory:** a listing of data in a local data set

**catalog:** information about the existence contents, and procedures for acquiring various data sets; may also contain additional information to help users judge the relevance of the data base to their particular needs.

---

While a subroutine in FORTRAN, such as a matrix inversion routine, represents a simple form of an object, the concept gains considerably in power when applied to data objects (c.f., Dittrich and Duval, 1986). By packaging data with

programs, the user need not know the detailed methods and formats of data storage and can deal with any data in the system on an equal footing. Any program which can retrieve information from one object or data type can retrieve similar information from any other data set in the system (or on the network). Plotting routines, for example, can plot data from the user's own machine or from elsewhere with equal facility. Figure 2 illustrates this point, superimposing data from Stommel's atlas (stored on a PC and from the North Atlantic Bloom experiment (on a SUN). The commands producing the plot are also shown; note the commonality between the "function" style of referencing the data objects.

The basic set of queries and answers has been carefully defined to permit transfer of hierarchically structured data of all types including character, integers and real numbers, vectors and tensors. We have studied a number of general formats for guidance on the requirements for an interchange protocol; ours corresponds to netCDF, with extensions and reorganization to better represent geophysical data. Also comments and attributes of the data (e.g. units) can be passed along with the data itself. Queries include the option of subsetting the data in various ways. Some methods can handle messages beyond the basic set. For example, the method for the CTD data in the North Atlantic Bloom archive deals with data at 2 decibar intervals but permits the user to select different increments (e.g. 100 decibar) to reduce the volume of data. Likewise it would be desirable to retrieve satellite data in discrete data form by asking for the value averaged over specified latitude and/or longitude bands. We are working on an example of such a method for numerical model output and for objective maps. Each method will be able to handle a message asking it for help on the method's capabilities. There must be an association between the name of a data object (e.g. '#bot' for the bottle data from the Bloom study), the data files (bloom/bot\*), and the proper method (bloom/jgbl) for handling messages working with the data in these files. This association is contained in a dictionary. Figure 3 shows part of the dictionary for the JGOFS North Atlantic Bloom Study. Note that there could be for example several distinct CTD-formatted data bases which would be known to the system as different objects but which share the same method. The relationship is therefore one-to-many a single method may apply to many different data sets. New data sets are added to the system in a simple way. The data must be placed on a machine which is connected to the network (this will often be the case already) and a method and dictionary entry provided. In many cases, users can choose to put their information in a form already handled by an existing method so that a new one need not be written. Thus for most data sets the data can be made available simply by providing a dictionary entry. We envision the data manager for the JGOFS program as having the responsibility for maintaining the catalog and verifying that the data is accessible. For the bloom study, we have constructed a prototype information object which can be viewed with the same software as any other object and can tell the user, for example, which data sets have total CO<sub>2</sub> measurements (Figure 4). Programs working in a 'data independent' way with the JGOFS data base will communicate with a 'server' (Fig. 5) which consults the dictionary and passes information and requests to the proper method. The server then returns the data to the program. In this sense, the server acts like an input

subroutine which the main program calls to get data from files. However, the server also acts to gather data from across the network. If desired, the server may send a message to a server on a different machine, asking for particular data objects. Subroutines which interface with the server directly have been constructed.

### **Data Base Operations:**

Up to this point, we have described essentially a 'data independent' method for exchanging data and working with a distributed data base. But data base systems also provide routines for manipulating data. For example, a relational data base which basically works with tabular data in columns with column headings, usually permits selecting by row or column and joining two tables together based on common columns (e.g. tables of data from two PI's working with water samples from the same Niskin bottles could be joined by matching the cast number/bottle number).

*(see Figures 3 and 4)*

An object oriented system permits data operations in a very simple and flexible manner: in addition to objects directly related to a set of data, the server will be able to deal with what we might call constructed objects" (Fig. 6). While these appear functionally the same to the user's programs, the data retrieved from these objects is, created "on the fly." Since each of the methods for constructed objects is an independent program, the system is indefinitely extensible. While this discussion has been phrased in terms of a relational model the individual data sets may be organized hierarchically or in some other manner. We have currently implemented the operations of selecting data by various criteria, choosing which columns to examine, mathematical operations and a join facility. In addition we have prepared examples of more specialized oceanographic operations such as dynamic height computation and mapping onto many different map projections.

We comment briefly here on the distinction between our proposed system and "data independent" formats such as the common data format CDF (Treinish and Gough, 1987), GF-3, DIF the UNIDATA program, etc. These efforts provide a flexible approach to storing all kinds of data and sets of subroutines for retrieval and, in some cases, manipulation and plotting of the data. In the case of CDF and GF-3, arbitrary data types are accommodated and the organization of the data can be specified. However these efforts are "top-down," in the sense that all data must be entered into the specified (general) format, the procedures for accessing the data are generally oriented towards large machines (e.g., FORTRAN and magnetic tape-based for GF-3), and most of the software comes down from one group. In contrast, we are adopting a "bottom-up" approach for which the goal is for each user to be able to work with data as if it were all stored in the fashion he or she prefers. There is no requirement to conform to a common standard (although if the

individual's preferences are quite different from anyone else's, it will be necessary to write a method). Given the proliferation and increasing power of microcomputers and the wide variety of systems for handling data (RS-1, STATPACK,... as well as those mentioned previously), we cannot expect a process of forcing the users into a common mode to be very successful: it will not be possible to have all the functionality desired by every user available in any single program. The approach we propose allows individuals to use freely the data storage and manipulation techniques they prefer, while still having straight-forward access to the entire JGOFS data base.

At the same time, it is important to take advantage of these other efforts, both from the point of view of the data already available therefrom and because of the expertise and experience others have had. Our low level interchange protocol is essentially a general data format, and we have designed it after careful consideration of the previous efforts in this area (though, of course, the details are largely hidden from most users by the method programs).

### Using the JGOFS System

To illustrate ways of using the system we describe two different approaches (Fig. 7): 1) For users without other data bases or those who prefer to use one of our general formats for storing their data we provide a fairly extensive set of tools for handling the data. These are the programs and constructed objects that we will use in our own work. In addition, as more scientists use the system and develop their own software, we can provide an extensive set of "groupware" so that one may be able to find a routine to execute the desired operation. The system will have much of the functionality of conventional data bases. Remotely-stored data can be either retrieved and saved on the local storage medium or may be used directly. 2) For users who are already handling data with a commercial data base system (e.g. LOTUS), the system would most likely be used with a program which talks to the server and writes results out in the form of a LOTUS data set (called "extr" in the PC version). It is then possible to retrieve remote data sets and have them arrive on the local system ready to be used directly—as far as the user is concerned the remote data sets are stored in LOTUS format. Secondly, by using a "method" for converting LOTUS data, one could take advantage of data manipulation capabilities of the data base system which may not exist in LOTUS. Essentially the program would ask the server to use a constructed object which itself requests other data from the server. This request for other data is passed along to the "method" for LOTUS data which retrieves the information from the LOTUS files. The data flows back to the constructed object which transforms it and passes it back to the main program. If the main program writes the results from an object out in LOTUS format, the desired result is obtained: a new LOTUS file has been created by operating on one or more old LOTUS files. The flow of data in this kind of operation is sketched in Fig. 7d. Note that some of the information could actually come across the network from files in completely foreign formats. Remember that the use of LOTUS in the paragraph above is only for example and is by no

means restrictive: similar capabilities can be made available to DBASE, netCDF, GF-3 etc. users.

Our data base system thus has five important features which distinguish it from conventional and available systems: 1) the ability to handle data in arbitrary formats 2) data transfer from remote, networked data sets 3) extensible—data manipulation routines or relational functions can be added at any time 4) new data can be added to the system in a simple way without a lengthy conversion 5) this system can be used either interactively or with user-written programs. We believe, based on experiences with various data sets and large oceanographic experiments, that these features are very valuable for JGOFS, WOCE, and Global Change.

## **Implementation**

### **User Programs, Methods, Constructed Objects,**

In our implementations, methods are separate processes which transfer information via interprocess communications routines. When the data object is opened, the method is started up and parameters are passed to it. The calling process then begins to receive information from the method as outlined in the "Interchange Protocol" section below. Because of the differences between a multiprocessing system such as UNIX and MS-DOS, we discuss each of these separately.

**UNIX:** In the UNIX implementation, the request to open a data object is passed via a queue to a resident server daemon. This forks a process to analyze the request, do the dictionary lookup, and begin the method. If the method program is local, it is started up and the parameters are passed to it using normal stdin/stdout pipes. The responses from the method are returned to the user program on the queue (Fig. 8). On the other hand, if the method is on a remote machine, the request is transmitted via a socket to a resident server on the remote machine, which again handles dictionary lookup, and starts up the method process. This time, however the responses from the method are passed back via the socket to the user process (Fig. 9).

**MS-DOS:** Here we have implemented a small resident set of routines which handle starting a subprocess and passing information back and forth. The user program first must release unneeded memory (this is often done as compiler options); it then handles the dictionary lookup and executes an interrupt to the server. The server executes the method process. The method generates an interrupt to the server, which then flips control back to the user program. Message passing then occurs as a sequence of such tips; the message string is pointed to by the registers at the time of the interrupt, and the server copies the string from the sender's area to the receiver's area when control is exchanged. The communications routine uses the serial port. First the user connects to the networked server

with a standard login process. The desired object is accessed with a method which talks to the serial port (e.g., v24 for 2400 baud).

### Interchange Protocol

At the core of the object oriented system is the interchange protocol. It must be sufficiently flexible to transmit data and information of many different kinds yet also simple enough that writing methods and inverse methods is not too difficult. At the same time, it place serious limits on the system if not sufficiently flexible. We have based our interchange format on netCDF, expanded to include hierarchical structure and comments. We begin our description of the basic protocol by discussing the replies which come from the method:

1. **Comments:** Plain text descriptive material which is transmitted with the data set. Here the scientist can describe details of the data acquisition, processing, and interpretation. References to relevant articles can be provided. Such information is vital for a data set which has long-term value.
2. **Variables:** The data is identified by named variables. These are grouped into different levels (e.g., cruise header, station header, station data). Within each group is a sequence of variable declarations. These consist of
  - A. **Variable name:** These must be unique within a data object. There is also a considerable advantage to using common names and units throughout a program (some of this work can be done by the method).
  - B. **Size, Dimensions:** For vector/ tensor quantities. these give the total size and the shape of the information.
  - C. **Attributes:** Here is given ancillary information on the variable. These take the form of strings attribute=value, along with a count.
3. **Data:** The data values are all transmitted as ASCII strings so that there is no intrinsic data typing. To understand the sequence of data transmission, consider a 3 level hierarchy as sketched in Figure 10. The first row of each level is transmitted; then the second and following rows at the lowest level. When data is one of the higher levels changes, then that row is sent along with the appropriate data from lower levels.
4. **End:** Signals all the data has been returned. Note that the data model employed is effectively equivalent to a relational model (augmented by comments and attributes) if one defines an operation which ungroups or flattens the data set and a grouping operator. Thus, we expect all of the operations common with relational databases can be implemented with our expanded model, although some care is required in order to automatically ungroup and regroup data.

Next consider the queries which the method may receive. When it first begins, the method receives a set of parameters—in the examples, these appear as arguments with the method or object name appearing as the function. Among these parameter strings, each method is expected to handle

1. **Projection:** Choice of which variables the method is to return.
2. **Selection:** Restrictions, based on the usual logical operations <=, >, <=, <>, >=. These selections are ANDed together.
3. **Help:** (Not implemented in prototypes.) Methods should be able to inform the

calling programs about the kinds of arguments they can handle. As described previously, methods may handle more than just these parameters; for example, the mathematical method deals with strings of the form `variable=expression`, with the variable perhaps being a new name and the expression being a standard FORTRAN style mathematical formula.

After the initial parameters are passed and checked, the method then simply receives requests for the next chunk of information and returns the next "row" of data. Or it may receive a request to terminate.

## Summary

We have constructed prototypes of the servers, methods, and constructed objects. We have much of the North Atlantic Bloom data entered into the system, along with various historical data sets and (separately) data from the SYNOP program. The process of documenting and training users will begin this year; assessment of the merits of the approach are still to come. However, we believe that, for on-going projects, on-line access to current data sets has many advantages. Likewise, the idea of building "extensible" data systems, analysis packages, and graphics packages should offer significant improvements in our abilities to share software.

## References

- Codd, E.F., (1990), *The Relational Model for Database Management*, version 2, Addison Wesley Publishing Co. Reading, MA, 538 pg. Date, C.J., (1990), *An Introduction to Database Systems*, vol. 1, Addison-Wesley Publishing Co., Reading, MA. 5th edition, 854 pp.
- Dittrich, K. and U. Daval, (ed.), (1986), *Proceedings of the 1986 International Workshop on Object-Oriented Database Systems*. IEEE Computer Society Press, Washington, D.C., 237 pp.
- Meyer, B., (1988), *Object-Oriented Software Construction*, Prentice Hall, New York, N.Y., 534 pp.
- National Academy of Sciences - National Research Council, (1991), *A U.S. Strategy for Global Change Data and Information Management*. (in prep.) Committee on Geophysical Data, Board on Earth Sciences and Resources. Natl. Acad. Press, Wash., DC, ca 33 pp.
- Treinish, L.A. and M.L. Gough, (1987), A software package for the data-independent management of multidimensional data. *Trans. Am Geophys. Union, EOS*, . 68(22): 633-635.



Waldrop, M.M., (1987), Artificial intelligence moves into the mainstream. *Science*, 237: 484-186.

Wegner, P., (1990), Concepts and Paradigms of Objected Programs. *OOPS Messenger (ACM)*, 1: 7-87.

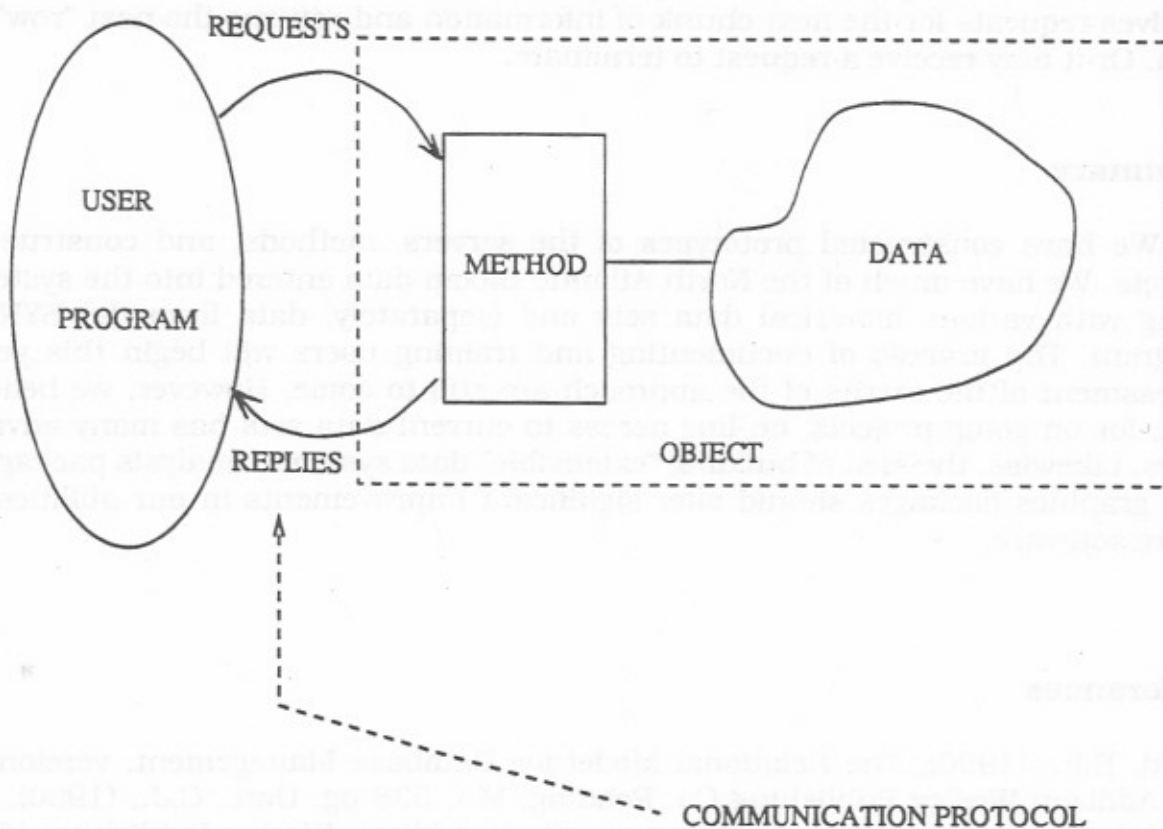

Figure 1. A data object packages together data and a program called a method. The data system accesses the information solely through requests and replies sent to the method. This communication protocol is common for all methods.

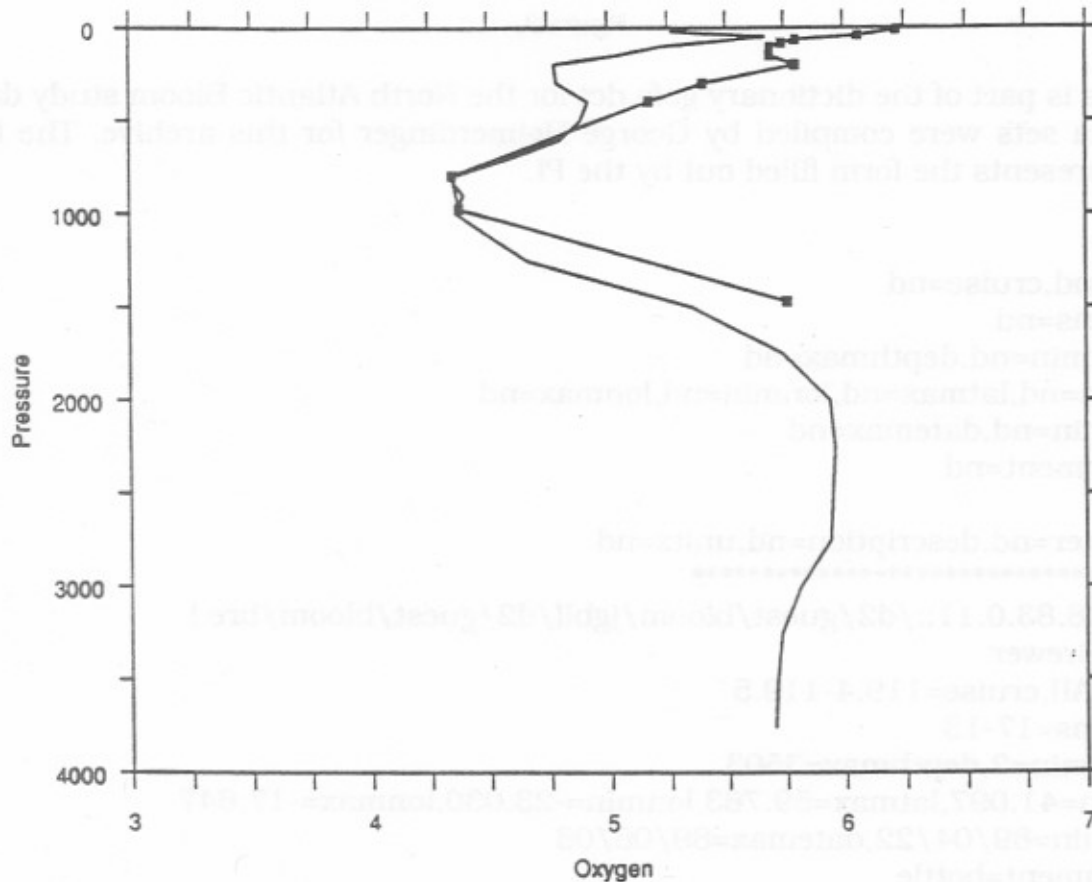

Figure 2. This figure was prepared with the following commands entered to MS-DOS (through the menu system):

```

window 3 4000 7 0
axis x .25 Oxygen 1 x
axis y 500 Pressure 1000 xxxx
plot ali (c:data Wunsch, *, station=75) o2 press
plot v24(#bot(*, station=24, cast=1) o2 press -3

```

The first line sets the data units for the lower left and upper right corners of the viewport. The next two draw the axes. The third plotted the solid line from data stored in an indexed version of the Stommel and Luyten form (one integer per variable, scaled suitably). Station 75 was at latitude 36.25 and longitude -22.77 and was taken in July 1981. The last line plotted the marked points from the North Atlantic Bloom bottle data (Williams, priv. comm.) on 5/10/89 at 41.097, -23.030. The "v24" method communicated over the serial line to the server.

Figure 3

This is part of the dictionary gofs.dct for the North Atlantic Bloom study data. The data sets were compiled by George Heimerdinger for this archive. The first part represents the form filled out by the PI.

```

&form
  pi=nd
  ship=nd,cruise=nd
  stations=nd
  depthmin=nd,depthmax=nd
  latmin=nd,latmax=nd,lonmin=nd,lonmax=nd
  datemin=nd,datemax=nd
  instrument=nd
&repeat
parameter=nd,description=nd,units=nd
*****
#tco2=18.83.0.11::/d2/guest/bloom/jgbl(/d2/guest/bloom/bre )
  pi=P.Brewer
  ship=All,cruise=119.4-119.5
  stations=17-13
  depthmin=2,depthmax=3503
  latmin=41.097,latmax=59.763,lonmin=-23.030,lonmax=-17.647
  datemin=89/04/22,datemax=89/06/06
  instrument=bottle
  parameter=press,description=nd,units=decibars
  parameter=alk,description=nd,units=uEq/kg
  parameter=tco2,description=nd,units=uMol/kg
  parameter=doc,description=nd,units=uMol/l
  parameter=doc_sd,description=nd,units=uMol/l
  *****
#poc=18.83.0.11::/d2/guest/bloom/jgbl(/d2/guest/bloom/duc)
  pi=H.Ducklow
  ship=All,cruise=119.4-119.5
  stations=15-13
  depthmin=2,depthmax=3468
  latmin=46.25,latmax=59.763,lonmin=-20.808,lonmax=-17.647
  datemin=89/04/22,datemax=89/06/06
  instrument=bottle
  parameter=press,description=nd,units=decibars
  parameter=poc,description=nd,units=uMol/l
  parameter=pon,description=nd,units=uMol/l
  parameter=thyincorp,description=nd,units=pMol/l/hr
  parameter=leuincorp,description=nd,units=pMol/l/hr
  parameter=bactabund,description=nd,units=cell/l
  *****
#bot=18.83.0.11::/d2/guest/bloom/jgbl(/d2/guest/bloom/bot)

```

```
pi=R.Williams
ship=All,cruise=119.4-119.5
stations=17-16
depthmin=0,depthmax=3503
latmin=41.097,latmax=59.763,lonmin=-23.030,lonmax=-17.647
datemin=89/04/22,datemax=89/06/06
instrument=bottle
parameter=press,description=nd,units=decibar
parameter=depth,description=nd,units=m
parameter=temp,description=nd,units=degC
parameter=theta,description=nd,units=degC
parameter=sal,description=nd,units=ppt(psu)
parameter=o2,description=nd,units=ml/l
parameter=o2sat,description=nd,units=ml/l
parameter=aou,description=nd,units=percent
parameter=no3,description=nd,units=uMol/l
parameter=no2,description=nd,units=uMol/l
parameter=po4,description=nd,units=uMol/l
parameter=sio3,description=nd,units=uMol/l
*****$*****
#ctd=18.83.0.11::/d2/guest/bloom/jgbl(/d2/guest/bloom/ctd)
pi=R.Williams
ship=All,cruise=119.4-119.5
stations=17-16
depthmin=0,depthmax=3518
latmin=41.097,latmax=59.763,lonmin=-23.030,lonmax=-17.647
datemin=89/04/22,datemax=89/06/06
instrument=ctd
parameter=temp,description=nd,units=degC
parameter=sal,description=nd,units=ppt(psu)
parameter=o2,description=nd,units=ml/l
parameter=theta,description=nd,units=degC
parameter=sigmat,description=nd,units=kg/m
.&end
#info=/d2/guest/bloom/infos(gofs.dct)
```

Figure 4

A dialog inquiring about data objects in the North Atlantic Bloom Study containing total CO<sub>2</sub> information.

```

/d2/guesttbloom> table
Input object(with projection/selection)?
#info(*,parameter=tco2)
1 object      2 objdef      3 pi          4 ship
5 cruise      6 stations    7 depthmin    8 depthmax
9 latmin      10 latmax     11 lonmin     12 lonmax
13 datemin    14 datemax    15 instrument  16 parameter
17 units
variable number or range xx,xx? (0 to finish,-1 for list)
1,3
variable number or -anse xx,xx? (0 to finish,-1 for list)
9,12
variable number or range xx,xx? (0 to finish,-1 for list)
0
Convert to real numbers? (0=no, 1=yes)
0
Stop at beginning of group? (0=no, 1=yes)
0
object objdef                pi      latmin  latmax  lonmin  lonmax
#tco2  jgbl(/d2/guest/bloom/bre) P.Breyer 41.097  59.763  -23.030 -17.647
#pco2  jgbl(/d2/guest/bloom/tak) Takahashi 41.097  59.763  -23.030 -17.647

```

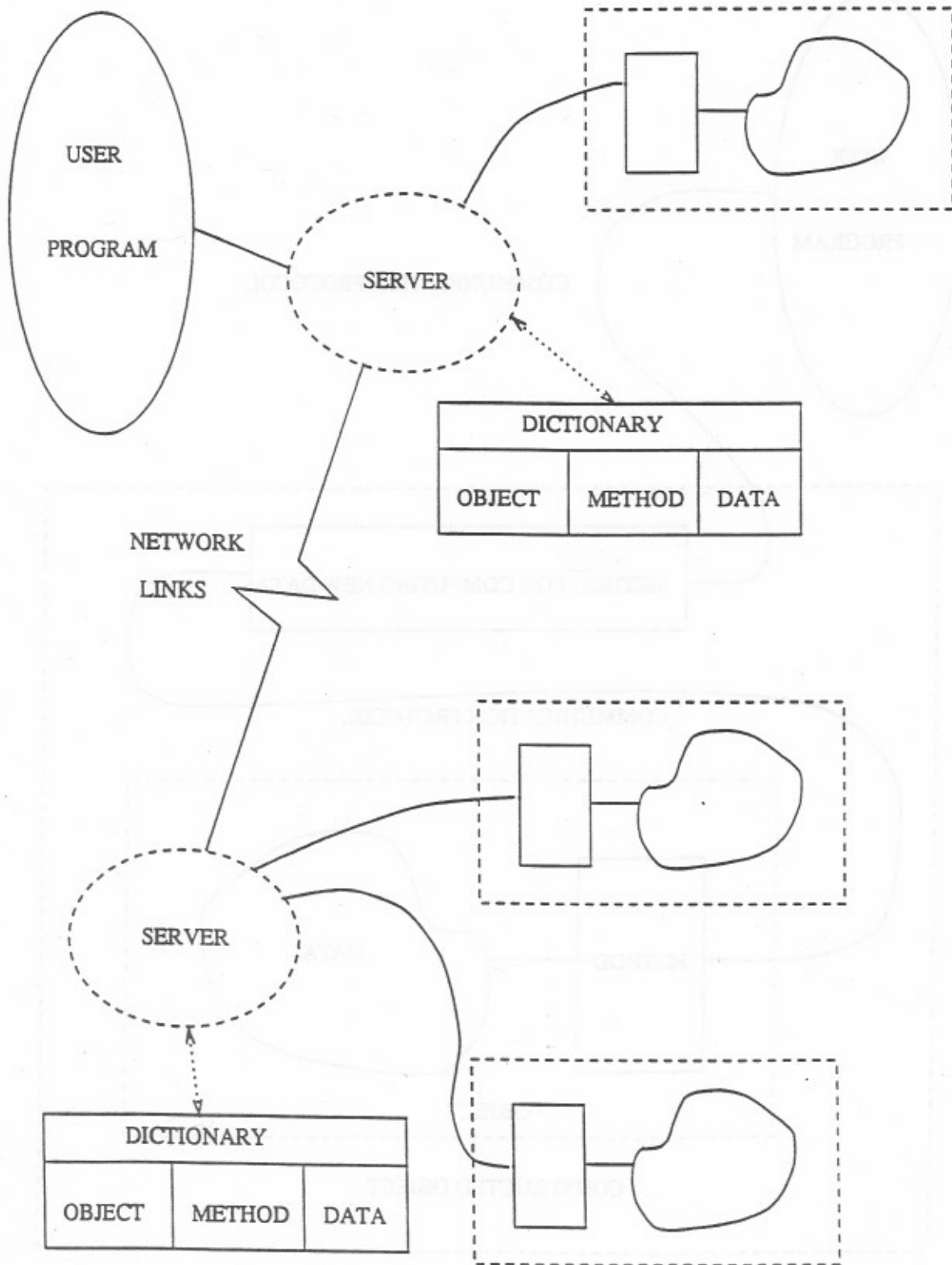

Figure 5. A server connects the user program to the proper method and data. A dictionary contains the mapping between object names, method and data. Note that one method can be used with multiple data sets. The server can talk over communications lines to servers on other machines as well.

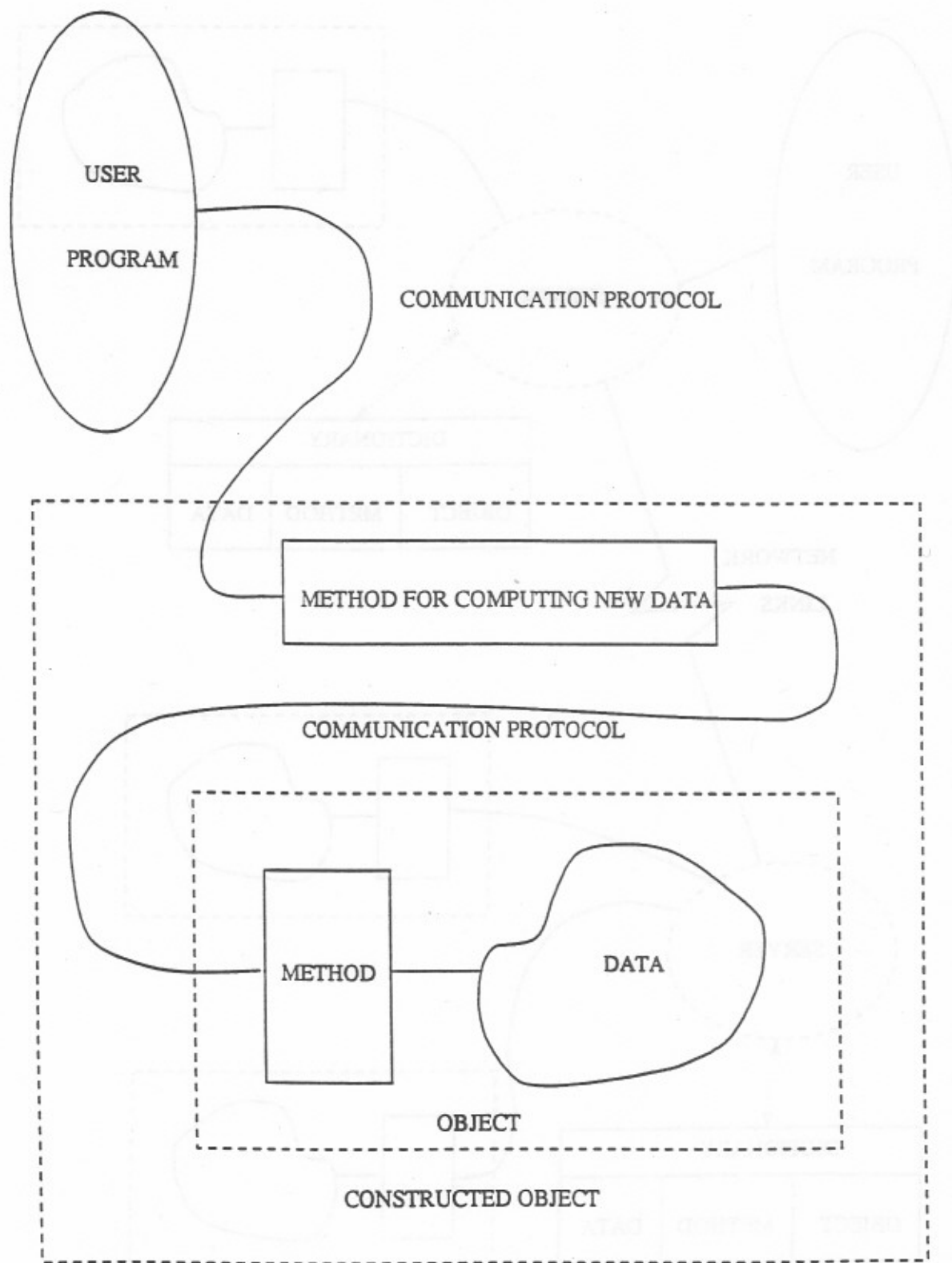

Figure 6. A constructed object consists of a method which builds a new data object from one or more data objects. Because it uses the communication protocol for both its input and output, it can be accessed by user programs just as another object, and it can work with inputs from any data objects in the system.

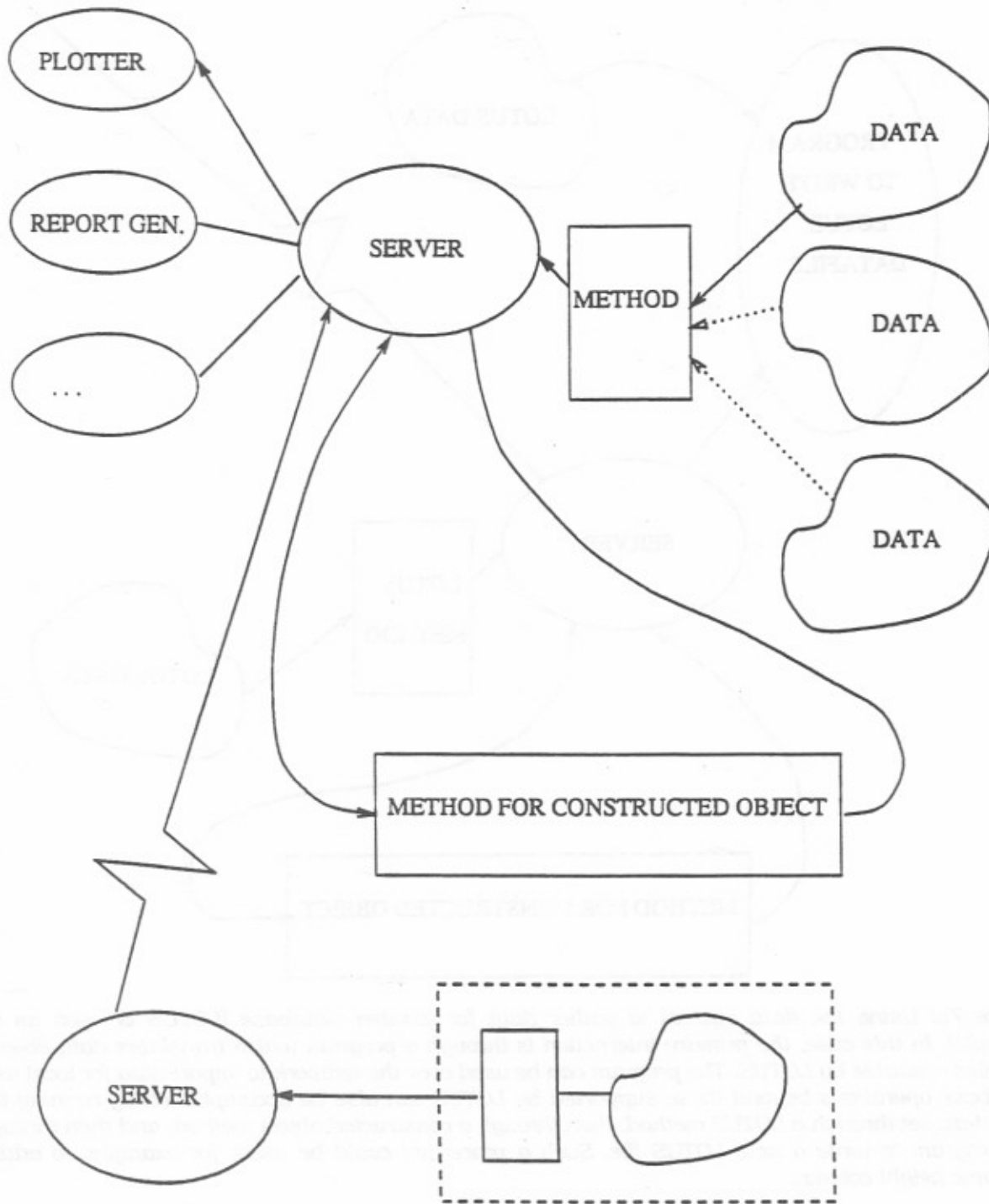

Figure 7a. Using the data system as a primary database: The upper part of the figure depicts local operations, such as reading data from various tables, merging them, and plotting the results. In this case, the user would often choose a single storage technique and use only a default method. In the middle is sketched a constructed object, used for data transformations. The lower part shows gathering related data from the network for local display.



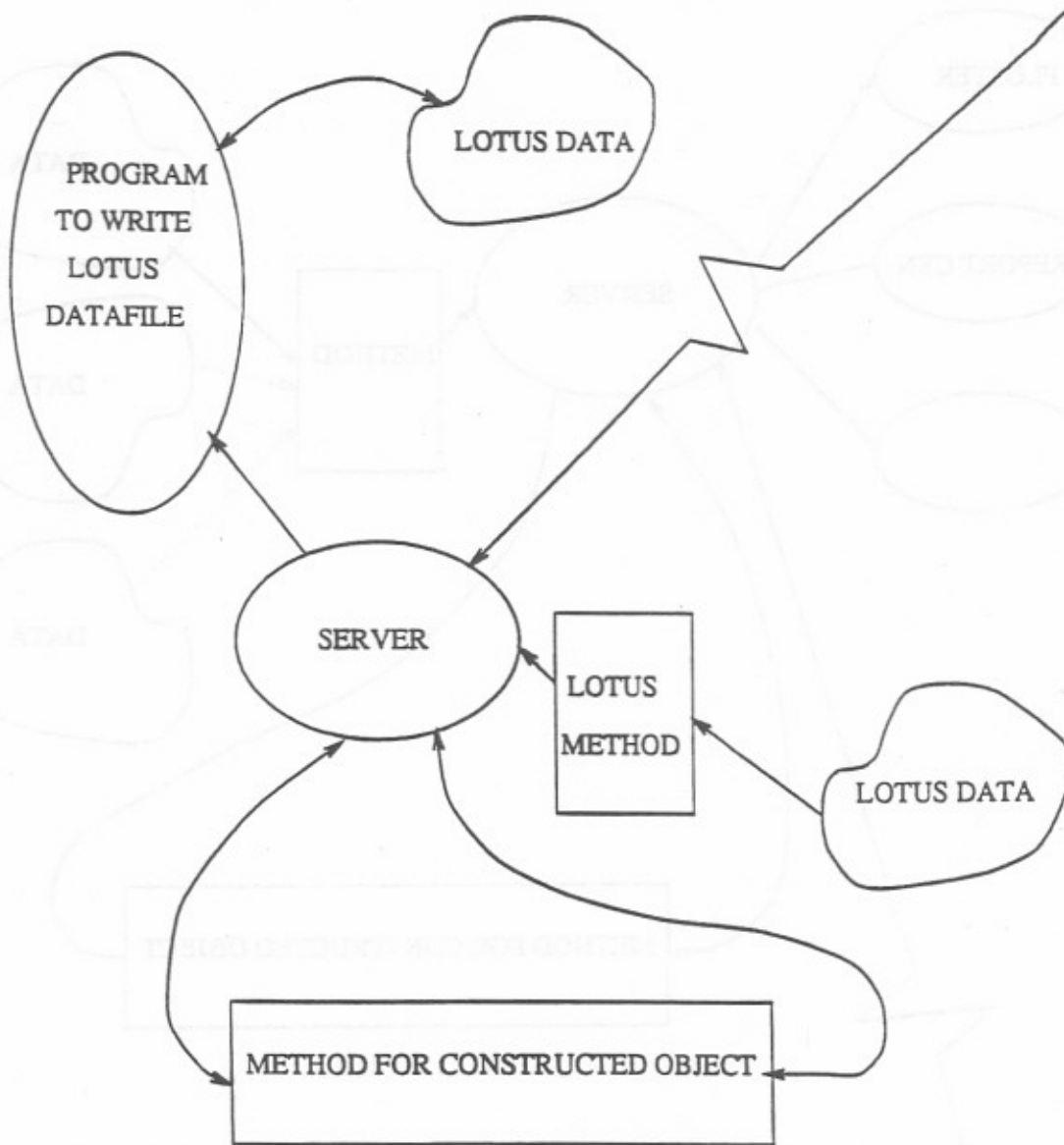

Figure 7b: Using the data system to gather data for another database (LOTUS is used as an example). In this case, the primary interaction is through a program which translates data objects into files readable by LOTUS. The program can be used over the network to import data for local use. Database operations beyond those supported by LOTUS can also be accomplished by running the local data set through a LOTUS method, then through a constructed object method, and then through the program to write a new LOTUS file. Such a procedure could be used, for example, to add a dynamic height column.

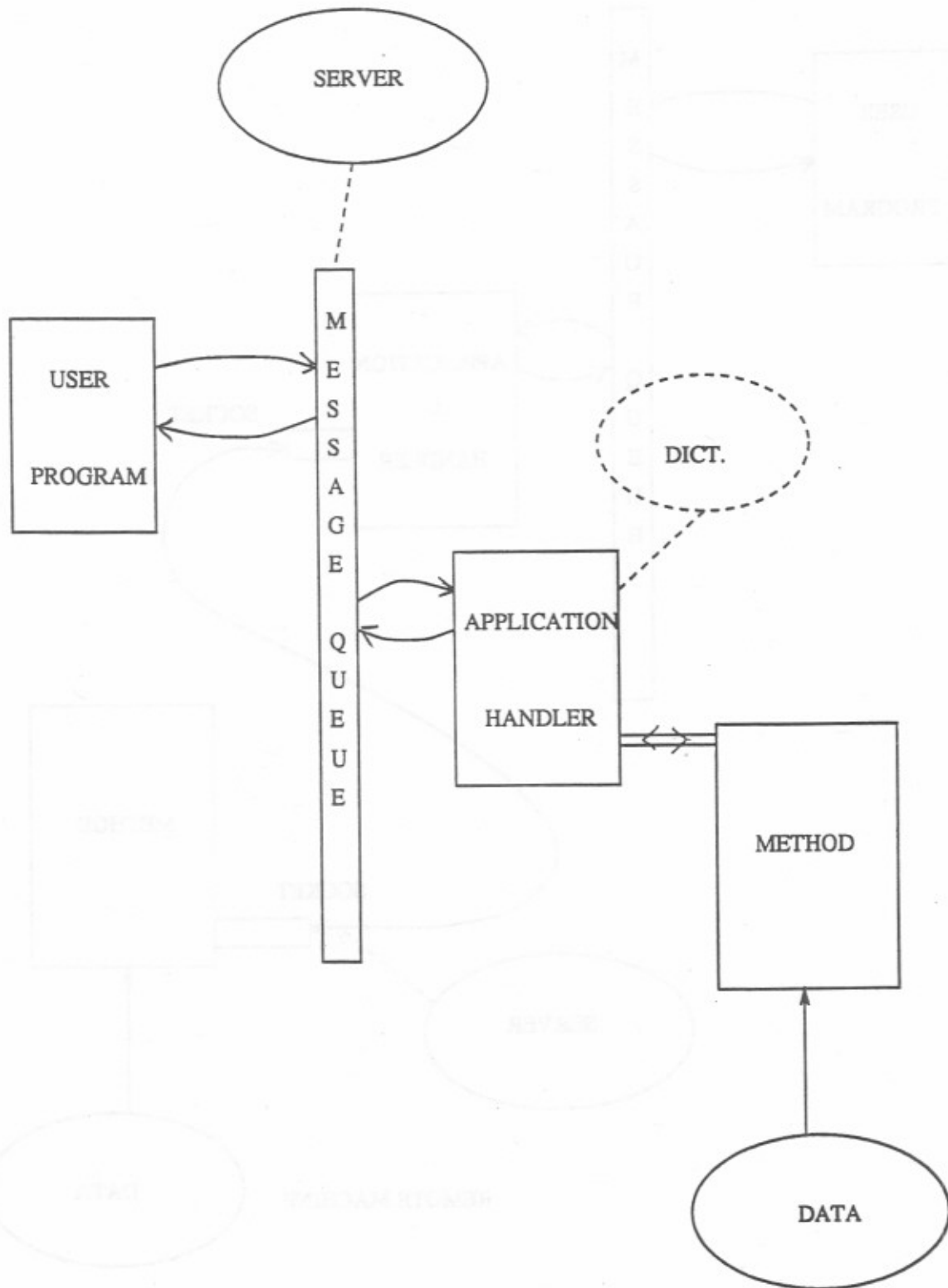

Figure 8. Flow of information in UNIX implementation for a local method. The server watches the queue and starts the application handler which looks up the object in the dictionary and starts the method. The protocol is passed from the server via a queue to the handler and then via a pipe to the method.

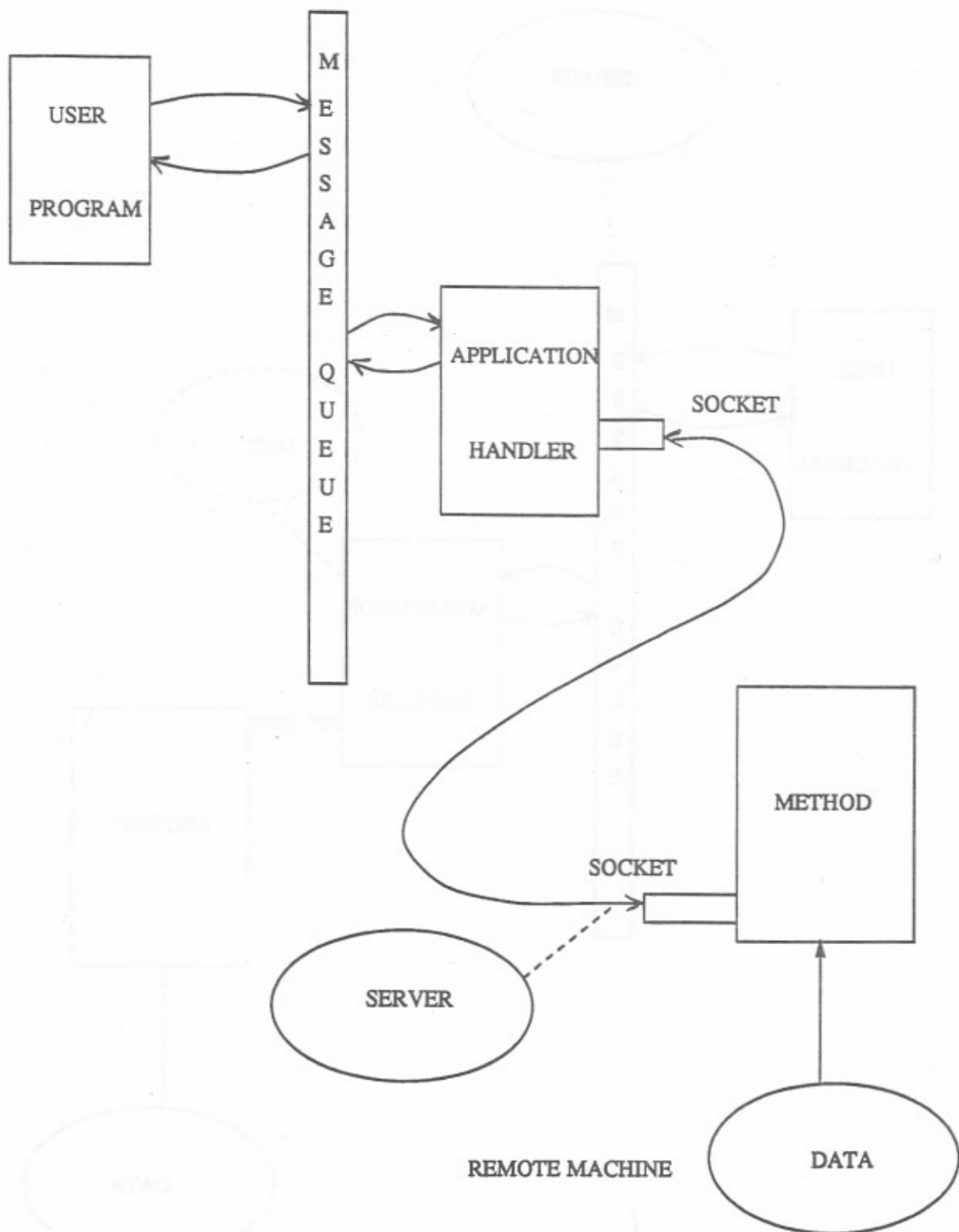

Figure 9. Flow for a remote method. The handler now communicates via a socket to the remote machine's server, which starts the method and connects it to the socket.

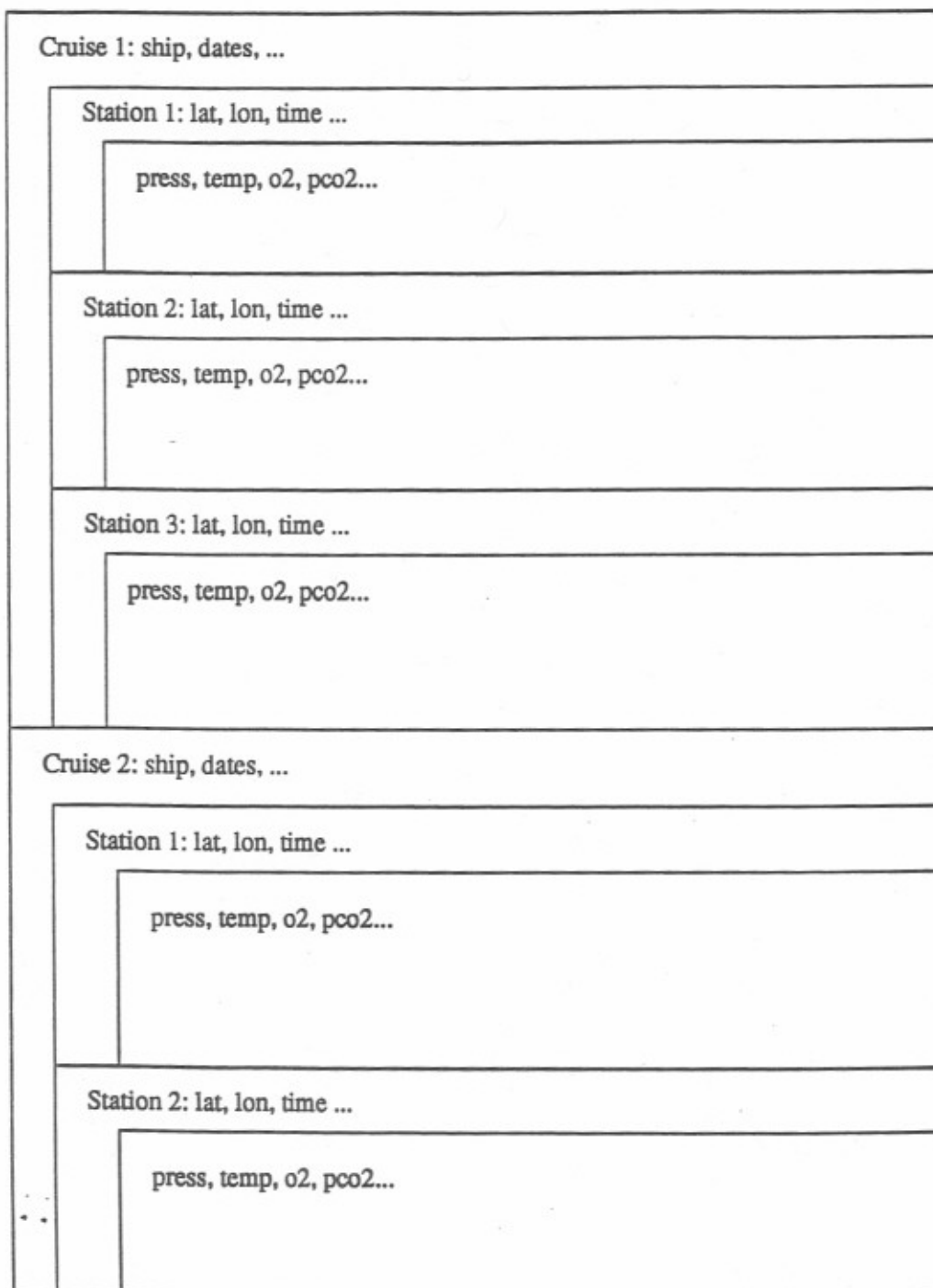

Figure 10. Hierarchical structure for a multi-cruise data object.

## **Data Management for Community Research Projects: A JGOFS Case Study**

---

**Roy K. Lowry**

### **Abstract**

Since the mid 1980s, much of the marine science research effort in the United Kingdom has been focused into large scale collaborative projects involving public sector laboratories and university departments, termed Community Research Projects. Two of these, the Biogeochemical Ocean Flux Study (BOFS) and the North Sea Project incorporated large scale data collection to underpin multi-disciplinary modeling efforts.

The challenge of providing project data sets to support the science was met by a small team within the British Oceanographic Data Centre (BODC) operating as a topical data centre. The role of the data centre was to both work up the data from the ship's sensors and to combine these data with sample measurements into on-line databases.

The working up of the data was achieved by a unique symbiosis between data centre staff and project scientists. The project management, programming and data processing skills of the data centre were combined with the oceanographic experience of the project communities to develop a system which has produced quality controlled, calibrated data sets from 49 research cruises in 3.5 years of operation. The data centre resources required to achieve this were modest and far outweighed by the time liberated in the scientific community by the removal of the data processing burden.

Two online project databases have been assembled containing a very high proportion of the data collected. As these are under the control of BODC their long term availability as part of the UK national data archive is assured.

The success of the topical data centre model for UK Community Research Project data management has been founded upon the strong working relationships forged between the data centre and project scientists. These can only be established by frequent personal contact and hence the relatively small size of the UK has been a critical factor.

However, projects covering a larger, even international scale could be successfully supported by a network of topical data centres managing online databases which are interconnected by object oriented distributed data management systems over wide area networks.

## 1 Introduction

The primary objective of all scientific data management is to provide the scientist with the data he (or she) needs to support their research. This objective contains three implications for the data manager.

- a) The data manager must ensure that the scientist is provided not just with the data but with sufficient information to allow the data to be used with confidence. This includes information on how the data were obtained, how they were processed and on the quality of the data.
- b) The data manager must provide the data in such a way that the effort needed to use the data is significantly less than the benefit obtained from the data. The required manner of presentation is obviously user dependent. For example, a biologist may easily obtain the information he needs about a density field from a graphical representation. However, a numerical modeller in marine physics is more likely to require the data in machine readable form in a format which he can easily incorporate into his software.
- c) The data manager must ensure that access to the data is maintained until it is universally agreed that the data are no longer of any value to the scientific community. In most cases this means long term maintenance for many decades and beyond.

Consequently, it can be seen that expectations of data managers are high. Not only is a thorough understanding of all types of data collected by the scientists needed but a thorough understanding of the needs of the scientific user community is also required.

This paper describes how this has been achieved in the United Kingdom by a unique partnership between a data centre and the academic scientific community.

## 2 The British Oceanographic Data Centre (BODC)

The British Oceanographic Data Centre (BODC) was formally created in April 1989. It is located at NERC's Proudman Oceanographic Laboratory at Birkenhead, Merseyside. Whilst managed by the host laboratory on behalf of NERC's Marine and Atmospheric Sciences Directorate (MASD) the BODC mandate is the provision of data management services on a directorate wide basis.

BODC developed from the Data Banking Section of the Marine Information and Advisory Service (MIAS) which was formed in 1976 primarily to provide support to the offshore oil industry by building a central archive of oceanographic data.

MIAS approached this problem by classical data archaeology. A data scout was employed to travel around the data collecting laboratories in the academic, government and commercial sectors persuading them to submit their holdings to

the data centre. Once submitted, the data were converted to a common format, screened, documented and loaded onto a database.

Inevitably, the problems associated with data archaeology were encountered. In many cases those collecting the data had lost interest in them and were unwilling to provide the necessary effort to resurrect the data. Much of the data submitted revealed the shortcomings of the parochial viewpoint of local data management and a significant 'data laundry' effort was required to bring the data to a standard where they were of general use.

During the eighties a shift in the source of funding caused the work of the MIAS Data Banking Section to evolve away from supporting the oil industry towards supporting science both in NERC and the universities. During this time the national data archive was further expanded to provide a significant national oceanographic data resource.

During 1988 the concept of BODC was developed with a mandate to:

- a) Maintain and operate the national data archive.
- b) Provide data management support to major programmes within NERC's Marine and Atmospheric Sciences Directorate (MASD).
- c) Make good quality oceanographic data available to UK research scientists, industry, local and central government.
- d) Collaborate in international data exchange and data management.

The data centre currently has 8 tenured staff, 5 staff on fixed term contracts and 4 industrial training students. This paper describes the work of BODC in support of two of MASD's Community Research Projects undertaken by 3 of these staff (1 tenured and 2 contract) plus 1 or 2 students.

### **3 BODC and the MASD Community Research Projects**

During the mid 1980s MASD developed the concept of Community Research Projects which aimed to target a significant proportion of MASD resources at a small number of specific scientific problems and involving scientists both from NERC's own laboratories and from university departments. Two of the initial projects to be set up, the North Sea Project and the Biogeochemical Ocean Flux Survey (BOFS), involved massive data collection efforts. The BODC remit was to ensure that these data were properly managed.

#### **3.1 The North Sea Project: Concept Development**

##### **3.1.1 Project description**

The proposed fieldwork for the North Sea Project consisted of 30 consecutive research cruises each of approximately two weeks duration: in other words 15

months of continuous sea time. The cruises were subdivided into alternate survey and process cruises. The survey cruises repeatedly worked a network of 123 fixed stations whilst the process cruises were short self contained studies covering a wide range of disciplines within the southern North Sea. In all cases, the primary sampling platforms were the ship's pumped water supply, a heavily instrumented CTD frame with a 12-bottle rosette and atmospheric sampling equipment. In addition, a smaller number of stations were worked using corers and zooplankton nets.

Working on the project were approximately 100 scientists from 4 NERC laboratories and 7 university departments scattered throughout the length and breadth of the United Kingdom. Imposed on this was an irrevocable time limit of 2.5 years after the end of the fieldwork for the completion of the project including a significant modeling effort using the data collected during the fieldwork.

### **3.1.2 Data management requirements**

Viewing this scenario from a data manager's point of view there were two basic requirements:

- a) The number of cruises and timescale was such that interpretation would have to be based upon a poor quality unrefined data set unless a highly efficient mechanism for working up the data was installed.
- b) Mechanisms had to be devised to give the project scientists easy access to the entire data set from their home laboratories.

### **3.1.3 Data processing**

The solution to the problem of working up the data required a radical rethink of the relationship between the project scientists and the data centre.

Let us first consider what would have happened in practice to the data automatically logged by the ship's systems had the conventional relationship between scientists and data centre been maintained.

The data are taken off the ship on magnetic tape in GF3 format. Each principal investigator (PI) would have required a set of tapes (at least 15 copies of a set of 4 or 5 tapes per cruise). Those responsible for the individual data channels would then have cleaned up and calibrated their part of the data and submitted them to the data centre.

The implications of this for the data centre are horrific. Consider the CTD instrumentation. Pressure temperature and salinity were the responsibility of one laboratory, oxygen a second, light and chlorophyll a third and transmissometer attenuation a fourth. Consequently, the CTD data would have arrived at the data centre as four separate files and almost certainly on four different timescales. The data centre operation to merge these files is a project manager's nightmare even if



one ignores the practical problems associated with identifying a common pressure channel.

The scenario would also have placed those PIs who were the users of the automatically logged data in a difficult position. They would have been faced with the difficult choice of dealing with the calibrating PIs direct, waiting for the worked up data to be available at the data centre or using raw data extracted from their copy of the tapes.

To avoid these pitfalls it was decided that BODC should adopt a radically different and far more active role in the data collection exercise. Instead of distributing the tapes to the PIs, only one set of tapes were generated and sent to BODC straight from the ship.

Here, the working up and quality control of the data were centralised. The data from the ship's tapes were first reformatted into disk files which could be handled by the data centre software tools. One of the most powerful of these, the SERPLO data inspection and flagging package (Loch, in prep) running on Silicon Graphics workstations, was used to despiked the data. Initially there were frequent consultations with the project scientists as to what constituted credible data. However, these became less frequent as BODC staff gained experience in North Sea oceanography.

The calibration of the data was an exercise in close cooperation between BODC and the project scientists. The way in which this worked is best considered by example. The fluorometer calibrations for chlorophyll were the responsibility of scientists at the Plymouth Marine Laboratory. Samples from the CTD water bottles were filtered and frozen on board ship, sent to Plymouth and the extracted chlorophylls determined. The extracted chlorophyll data were sent to BODC over the UK academic network (JANET) where they were matched to fluorometer voltage readings and the combined file was returned to Plymouth. Here, project scientists identified rogue extracted chlorophyll values and determined the calibration equations. This information was returned to BODC where the equations were applied to obtain the calibrated data set.

The success of this method of working may be judged by the fact that, within three months of the last cruise docking, the data from all 30 project cruises were fully worked up and available for use.

The advantages of this method of working are as follows:

- a) Maximum use is made of the skills available. The data centre offers project management, programming and data handling skills whereas the project scientists offer experience in instrument calibration and North Sea oceanography.
- b) necessary information flow is not inhibited by the communication problems which inevitably arise between groups working independently.
- c) Scientific management is able to obtain progress and status reports from a point source.

- d) The maintenance of a common independent variable for all data channels is assured.
- e) Data centre staff are integrated into the scientific project team which both provides motivation and ensures that the data management does not become divorced from the research.

#### **3.1.4 Providing access to the data**

Having solved the problem of how to work up the data, the mechanism for making the data available to project scientists required consideration. The required data set not only included the automatically logged data worked up by BODC (and therefore present in the data centre) but also the results of laboratory analyses of samples collected on the cruises which were in the possession of the PIs.

The solution adopted was to load the data into an online database managed by BODC. In taking this approach there were a number of problems which had to be addressed.

##### **a) *Choice of platform and software environment***

The choice of platform and software environment was dictated by circumstances. There were considerable advantages to be gained from hosting the database on the computer facilities available at the Bidston site. It was clear that adequate resources were available here and so the database was implemented on the Bidston computer, an IBM 4381 mainframe under VM/CMS running the ORACLE RDBMS.

##### **b) *Technical aspects of user access***

Within the UK, all academic institutions (including NERC laboratories) have computer facilities interconnected by the JANET wide area network. Consequently, it was possible for any project scientist to log onto the Bidston IBM from their home laboratory.

However, achieving this in practice required careful consideration if it was to be done without compromising either the data security by releasing it to nonproject participants or the system security by providing an opportunity for hackers.

The platform available for the database made the solution awkward. The obvious method would be to set up a project account on the system with the minimum of privileges required to interrogate the database. The password could then be made known to project participants and modified as necessary to maintain security in an inevitably dynamic user population.

However, VM/CMS only allows one user at a time to be logged onto a specified account. There is also less control over user privileges than with other operating systems such as Unix or DEC's VMS. Consequently, each user had to be given an account on the Bidston system which were configured by BODC to grant the privileges necessary to access the data.

This solution worked well in practice despite the administrative burden and no security compromises have been reported in almost two years of operation.

c) **User education**

There is no point in creating an online database if the project scientists do not have the knowledge or expertise to obtain the data they require from it. The problem was approached from two directions.

First, the user interface to the data retrieval was made as friendly as possible. This was aided by the user-friendliness of the database interrogation language provided by ORACLE, SQL, which is syntactically similar to plain language and hence easy to learn. However, some queries, particularly those requiring information from several tables can become quite complex. Some of these may be simplified by the creation of database views but situations were identified where commonly required information could not be obtained easily.

In these cases high level language programs implemented as additional CMS commands were written to simplify the user interface. Consider the example of retrieval of a CTD cast from the database. This requires retrieval of station position information from one table, the raw datacycles from a second and the calibration coefficients from a third. In addition, the calibration equations need to be applied to the raw datacycles. Whilst this is possible using SQL, it is extremely cumbersome. However, with a high level language application all that is required of the user is the simple command:

```
CTDLIST <station id>
```

Similar commands were implemented to allow data retrieved from the database to be represented graphically, including contouring software, and output on a range of graphical devices. This gave the user the ability to log onto Bidston, produce a graphical image file, network it to his home computer and generate a plot.

Secondly, steps were taken to ensure that the user was provided with all the information needed to retrieve data from the database. To this end a comprehensive manual describing the database structure and all BODC implemented commands was produced. Several users have successfully mastered the database using this together with system documentation provided by NERC Computer Services and a little interactive help.

Further, the induction of the initial user population, awaiting the database launch, was accelerated by holding a 3-day training course at Bidston. This covered SQL syntax and usage, the database structure and how to run the BODC supplied software with a strong emphasis on hands-on experience.

The course was attended by over 15 scientists, mostly research assistants, and was well received by all. Many of the attendees have subsequently passed on the knowledge gained to their colleagues and have greatly assisted BODC by providing local support to other users.

d) **Obtaining the sample data set**

When building a database the technical problems associated with design and implementation fade into insignificance when compared to the problems associated with obtaining the data from the scientists who collected them. However, these problems were found to be far less severe in the case of the North Sea

Project database. As BODC had worked up the automatically logged data these were in house and ready for load. Further, a significant proportion of the sample data set (chlorophyll, dissolved oxygen, sediment gravimetry and salinity) had been submitted to BODC during the calibration exercise.

The flow of remaining data into the database were lubricated by five factors which motivated the scientists to submit their data to BODC:

- i) The automatically logged data worked up and held by BODC could be used as currency in the sense that they provided a readily identifiable product coming out of BODC in return for the data coming in.
- ii) The project scientists soon learnt that once individual sample data sets were loaded into the database they were automatically linked to other measurements on the same samples. Consequently, a merged data set could be obtained from the database with no effort on the part of the scientist.
- iii) Value added data products, such as contour plots, could be easily obtained from data held in the database using software supplied by BODC.
- iv) The project fostered a genuine team spirit and broke down a lot of the mutual distrust which had previously existed between scientists. BODC's active involvement meant that the scientists viewed the database as a part of their research project and therefore contributed to it willingly.
- v) BODC took great care to ensure that they were perceived as honest brokers of the data who would not allow access from outside the project until the data were formally placed in the public domain.

The degree of success in obtaining the data may be judged from the fact that, by February 1990, over 75 per cent of the data collected on the 30 project cruises had been lodged with BODC i.e. within four months of the end of the 30th cruise. At the current time (December 1991) this figure has risen to over 95 per cent.

#### e) Quality control

The arrangement with the project scientists was that responsibility for quality control should rest with the PI. In the case of the automatically logged data this was achieved by interaction between BODC and the PIs at various stages during the data processing exercise. In the case of the sample data sets BODC assumed that the data were quality controlled prior to submission.

However, each data set was subjected to brief scrutiny to ensure that no gross corruptions of the data had occurred. Further, it was discovered that a relational database is a powerful quality control tool enabling data comparisons to be made over many permutations in a relatively short time. A number of problems were uncovered in this way during routine checks on the database and resolved by consultation with the PI concerned.

During the building of the database an unexpected quality control problem emerged. The physical firing of a water bottle can only take place in one position in space and time. This is not the case for the recording of that event in five scientist's log books! The CTD used in the North Sea Project was known to overestimate pressure by 2 db. The water bottles were physically located

approximately 2 m above the CTD pressure head. This meant that the depth of a bottle fired with 10 m of wire out in still water could be recorded as 10 m (wire out), 12 m (corrected CTD pressure) or 14 m (uncorrected CTD pressure) depending upon the definition used for 'bottle depth'.

As bottles were fired with a depth separation of as little as 2 m this represented a real problem which only came to light during the assignment of sample identifiers at BODC. Significant BODC effort was expended resolving the problem by designating authoritative bottle firing depths using a consistent definition.

It is worth noting that had a distributed database approach been adopted this problem would only have come to light when users attempted a merge of sample data sets retrieved from more than one source. The result would have been chaotic with much time wasted by duplicated effort.

The North Sea Project database was formally opened to the user community on 1st March 1990 only 5 months after the main phase of data collection was completed. Subsequently, data from a comparatively small amount of additional fieldwork in 1990 (8 cruises in all) have been added to the database.

It is currently in daily use with over 30 active user accounts which service the data requirements of well over 50 project scientists. Its success, together with that of the BOFS database, will be objectively reviewed later in this paper.

### **3.2 The BOFS Community Research Project: An Extension of the Established Principles**

#### **3.2.1 Project description**

The Biogeochemical Ocean Flux Survey (BOFS) represented the initial UK contribution to JGOFS, and commenced fieldwork in 1989 (3 cruises) with further field seasons in 1990 (6 cruises) and 1991 (2 cruises). In each field season, survey work and process studies were combined both during and after the spring bloom centred along the 20W line in the North Atlantic.

Again the project involved between 50 and 100 scientists from 2 NERC laboratories and 8 universities. However, the project community differed markedly from the North Sea Project with only a handful of scientists involved in both projects.

#### **3.2.2 Differences between the North Sea Project and BOFS data management requirements**

The data management strategy pioneered for the North Sea Project had worked well and therefore the logical way to proceed was to apply the same principles to BOFS.

Therefore, in general, what has been discussed above in the context of the North Sea Project is equally applicable to BOFS. However, the BOFS project differed, in data management terms, from the North Sea Project in a number of ways.

- a) BOFS was essentially a deep ocean study whereas the North Sea Project was totally contained in a shelf sea shallower than 100 m. This required minor modifications to the data processing procedures and a reassessment of the criteria used for quality control decisions. Sufficient deep sea oceanographic experience was available in the BOFS community to guide BODC so the transition was achieved without problem.
- b) The BOFS data set was much more diverse both in the range of parameters that were automatically logged and in the range of measurements made on samples collected during the cruise. In addition, these samples were taken using a much wider range of oceanographic hardware. Again this meant that the BODC systems had to be extended and the complexity of the database schema increased. However, the effort required to make these changes was minimal.
- c) The North Sea Project was planned in terms of a predefined set of measurements which were intensively and repeatedly taken. The design of the database was therefore relatively easy to establish at the beginning with a fair guarantee that it would not need to change during the project.

However, BOFS was organised in a very different way. After each field season scientific meetings were organised where the results of that season were discussed and used to formulate the fieldwork requirements for the next year.

Consequently, the required database schema inevitably changed as the project progressed. In the past this would have presented a major problem with each change to the database structure requiring a complete dump and reload of the database. However, the ORACLE RDBMS allows additional tables to be specified, columns to be added to tables and even changes to column specifications with the data in place. Consequently, the database was easily able to adapt to the changing requirements of the science.

- d) In the North Sea Project principal investigators were designated for the measurement of the basic environmental parameters such as temperature, salinity and chlorophyll. It was these PIs who worked closely with BODC in the instrument calibrations. However, BOFS was directed more towards supporting innovative measurements. Whilst this had clear scientific benefits, it meant that there was no clearly defined responsibility for the calibration of these basic, but nevertheless vital, parameters.

The problem was solved by BODC expanding its role by taking responsibility for the calibration of the CTD sensors and those instruments connected to the ship's pumped water supply for which there was no designated responsibility within BOFS. Nevertheless full advantage was still obtained from the pool of expertise within the BOFS community with acknowledged experts acting as consultants where required.

### 3.2.3 The importance of sample coordinates

These relatively minor difference apart, the BOFS database was built up in exactly the same way as the North Sea Project database. Due notice was taken of lessons learned during the North Sea Project. For example, it was realised that it was vital to establish authoritative coordinates in time and, particularly, space for all of the samples collected. Consequently, much effort was put into obtaining copies of 'soft' data collected during the cruise such as log sheets. With all of this information collated centrally, discrepancies could be resolved and the space time coordinate framework could be established within the database with confidence.

The importance of resolving any problems with sample coordinates in a multi-disciplinary study cannot be overemphasised. Errors can lead to false comparisons and experience handling the two Community Research Project data sets shows that such errors are frequently encountered.

Even such basic procedures as labeling stations can go badly wrong. For example, on one cruise the CTD station numbers given to the computer files got out of step with the station numbers used by the scientists taking samples from the water bottles. The confusion was furthered by the numbering system adopted which allowed overlaps to develop: the sample numbers matched a CTD file but it was for a CTD dip taken 12 hours after the samples were taken.

Ideally, these errors should be eliminated at source. However, anyone who has experienced the working conditions on a research cruise will realise that this may not be possible. The danger of these errors is not that they are made but that land based data managers assume that such errors cannot be made and design systems accordingly.

### 3.2.4 Providing access to the BOFS data

Scientists were given access to the database in exactly the same manner as the North Sea Project. Each user, or group of users was provided with a suitably configured account on the Bidston IBM. It should be noted that this was done in such a way that BOFS users were excluded from North Sea Project data and vice versa.

User education again precisely paralleled the North Sea Project with a detailed Users' Guide and a 3-day course held at Bidston. This was run in February 1991 and was more heavily attended than its predecessor with over 20 scientists participating.

One final parallel between the two databases is that the BOFS database is also regularly used by scientists to satisfy their data requirements.

## **4 An Objective Assessment**

There are a number of questions which one may ask of a data management exercise to assess whether it may be deemed a success.

- a) What products have been produced?
- b) Have the products been produced cost effectively?
- c) Have the products been made available on a reasonable timescale?
- d) Are the products actively used by the scientific community?
- e) Have the objectives of the data manager been satisfied?

### **4.1 What Products Have Been Produced?**

In the case of BOFS and the North Sea Project, the data products are obviously the two on-line databases that have been assembled and made available to the project scientists. The current data holdings in each of these databases are listed in Appendix 1.

### **4.2 Have the Products Been Produced Cost Effectively?**

In order to answer this question, we must first establish some measure of cost effectiveness. From the BODC point of view cost effectiveness is judged by the quantity and quality of the data set assembled costed against the manpower required to produce it.

During the 1980s MIAS (the precursor to BODC) was funded to assemble a data set of CTD data collected by UK laboratories. This was a typical example of conventional data archaeology and therefore provides a useful comparison. The CTD project was operated as follows. First, an inventory was compiled from sources such as ROSCOP forms. The scientists who collected the data were then approached and asked to submit their data to MIAS.

The data that were submitted were converted into a common format, units standardised (including calibration work), screened on a graphics workstation and loaded into the national data archive together with qualifying documentation.

The resources available for this project were 2.4 man years of data centre staff effort. At the end of the project, between 6,000 and 7,000 CTD casts had been added to the national data archive. The figure for resources only includes data centre effort. An unspecified, but significant, amount of scientist's time had been spent working up the data prior to their submission to MIAS.

Compare these figures with the resources required to assemble the BOFS and North Sea Project data sets described in Appendix 1. To date, 3 man years of BODC staff effort have been expended on each project supported by 4 man years of industrial training student (undergraduate students whose course includes one year working in industry or a scientific institute) support. These figures include all project software development and data processing as well as the loading of the



data into the databases but make no allowance for the BODC infrastructure, such as existing software systems, which was used as extensively as possible.

These figures clearly show that the data management strategy adopted by BODC for the Community Research Projects considerably outperforms in cost effectiveness terms the data archaeology approach, particularly if the scientist's time saved by BODC's data processing efforts is taken into account.

#### **4.3 Have the Products Been Made Available on a Reasonable Timescale?**

Once again a data management project previously undertaken by MIAS may be used for comparison. The JASIN project in 1978, JASIN78, was an intensive multidisciplinary field study involving several research vessels off the NW coast of Scotland. The assembly of the data set for this project was the responsibility of MIAS. Project scientists were given a clear mandate to submit their data once they were worked up. It took between 4 and 5 years for these data submissions to arrive at the data centre.

In contrast to this the BOFS database containing the data from the field seasons in 1989 and 1990 was available 8 months after the completion of the 1990 field season. However, prior to the launch of the database BODC were servicing requests for data from the partially built database and the disk files awaiting load. The underway and CTD data for the 1991 field season (in July) were available for a workshop in early December 1991 and the loading of the 1991 sample data should be completed by February 1992.

The timescale for the North Sea Project was even shorter. The database, containing all the automatically logged data and 75 per cent of the sample data set, was opened to the community only 5 months after the last cruise of the main data collection phase docked. Again access to the data were provided by a request service until the database was released. Indeed, much of the delay in bringing the BOFS database on line was due to resources being tied up servicing North Sea Project requests.

#### **4.4 Are the Products Actively Used by the Scientific Community?**

An online database is only of value if it is actively used by the scientific community for which it was provided. Usage of the BOFS and North Sea Project (NSP) databases have been monitored by BODC and the results are presented in the table below:

Month	Number of users		Number of database sessions	
	NSP	BOF	NSP	BOFS
May 90	5		35	
Jun 90	5		37	
Jul 90	5		126	
Aug 90	7		104	
Sep 90	5		69	
Oct 90	4		35	
Nov 90	7		113	
Dec 90	6		97	
Jan 91	9		67	
Feb 91	9	14	79	79
Mar 91	6	6	28	25
Apr 91	7	5	114	24
May 91	7	2	82	3
Jun 91	7	4	54	17
Jul 91	9	4	144	118
Aug 91	6	4	53	31
Sep 91	6	3	37	14
Oct 91	6	1	35	5
Nov 91	7	5	49	28
Dec 91	6	3	72	25

The number of users is the number of different project scientist accounts which have activated the database login macro during the month. The number of database sessions is the number of times the database login macro has been invoked during the month. These figures exclude the activities of BODC staff and accesses to the database using the BODC software interface which cannot be monitored for technical reasons.

These figures demonstrate that both databases are in regular use. The patterns of usage show a marked contrast between the two project communities. Much of the North Sea database access is by a group of 4 or 5 users who regularly log onto the database indicating that they are using the database as a data analysis tool.

However, in the case of BOFS there is very little overlap in the user community from month to month. This indicates that users log onto the database and siphon the data they require into their home system for analysis. Contact with the BOFS community also indicates that they use the interface software in preference to

native SQL and consequently the figures above significantly underestimate the usage of the BOFS database.

One can only speculate as to why this difference in database usage patterns has developed. Possibly it is because the BOFS community contains a higher proportion of scientists whose computing is based on PC packages and hence are uncomfortable in a mainframe environment.

#### **4.5 Have the Objectives of the Data Manager Been Satisfied?**

In the introduction to this paper it was stated that the objective of the scientific data manager was the provision of data to the scientist. In this, the exercise has definitely succeeded as all the project scientists know they can look to BODC for the data, and supporting information, they require. In terms of BODC's objectives both projects can be seen to have succeeded. The provision of data management support has been clearly demonstrated. Furthermore, once organised into in house project databases, the data may easily be incorporated into the national data archive.

In summary, by adopting a different approach to data management BODC now has two large multidisciplinary data sets in-house months rather than years after they were collected.

### **5 The Implications for Large-Scale Data Management**

#### **5.1 Data Management in JGOFS**

Let us start this discussion by looking at data management within JGOFS for the data collected during the North Atlantic Bloom Experiment (NABE) in 1989. During this experiment research vessels from the USA, Canada, Germany, the Netherlands and the UK undertook a coordinated study along the 20W line northwards from 47N during the 1989 spring bloom.

JGOFS data management representatives for the NABE first met at Kiel in March 1990. Here, a model was adopted whereby project data management would be achieved by mutual exchange between the national data management representatives who would then service the needs of their respective scientific communities.

This has met with limited success. From the UK viewpoint, the American data are available as a comprehensive data report, including full documentation, backed up by data in machine readable form on floppy disk. The Canadian data are available as a set of floppy disks containing a set of Lotus spreadsheets with no accompanying documentation. The Dutch data are available as hardcopy listings without documentation or data in machine readable form. No readily identifiable German data set is available.

The UK data are currently available to the other NABE participants via a request service operated by BODC. Requests for data are submitted via the other national data management representatives and the data supplied on floppy disk, tape or as networked files. Data have been supplied in this way to scientists in the USA, Canada, Germany and the Netherlands with a turnaround of the order of a couple of weeks.

What has gone wrong? The answer is simply that data management in JGOFS has been grossly under resourced. Of the five nations participating in the NABE only the UK and USA had dedicated data management resources available in 1989. The Canadian and Dutch data sets were assembled by scientists taking on the data management responsibility in addition to their research work. In Germany, a data management project was submitted for funding in competition with research projects and failed. However, some resources have subsequently (in 1991) been designated to the assembly of the German NABE data set at the German data centre.

Even where resources have been allocated, they are insufficient to give JGOFS data management the support it deserves. In the case of the UK, the resources were allocated to support BOFS and therefore the processing of the data from the BOFS cruises in 1989, 1990 and 1991 and its assembly into an online database has had to be the first priority. Finding the resources required to support JGOFS i.e. by completing the task and assembling the necessary data documentation for use by scientists not involved in the field programme, has proved problematical.

The question of how the data management of large multi-national projects should be approached must therefore be addressed.

## **5.2 The Centralised Model**

The data management approach adopted by BODC for the North Sea Project and BOFS has worked. The question is whether such an approach could be extended to a large multi-national project such as JGOFS. The answer would have to be no for the following reasons, mainly associated with problems of scale.

- a) BODC's success in the UK has resulted largely from the strong working relationship developed between the project scientists and data centre staff. This has been achieved by data centre staff visiting laboratories, attending scientific meetings and participating in research cruises. Whilst this is feasible within the geographical confines of the UK, if attempted on an international scale more time would be spent traveling than working on the data.
- b) The NERC research vessels utilise common hardware and data logging software and are operated by a single organisation. The interface between the research vessels and the BODC data processing system was therefore relatively easy to set up and operate. Even so, problems were encountered where individuals adopted different working practices at sea. Such problems would inevitably be magnified in a scenario where the research vessels were independently managed with incompatible hardware and software systems.

- c) It would be difficult, if not impossible, to grant access to any database on equal terms for all the contributing nations. In particular, a centralised data centre inevitably requires a host nation whose scientists would be perceived as being in a privileged position.

### 5.3 The Distributed Model

Let us now consider the opposite extreme of totally distributed data management. In this case, each Principal Investigator throughout the project is responsible for an individual data set. The data sets would usually either be a single set of sample measurements or the data logged by an individual instrument and would be stored under the PIs home hardware and software environment.

These isolated data sets are then linked and opened to other project scientists by a distributed data management software system. Two systems of this type are known to the author: the system set up in the USA for US JGOFS data management (Flierl, 1992) and the system set up at Lamont for managing Earth Science data (Menke et al, 1991).

Both of these systems are based upon the interrogation of databases fronted by software interfaces using a standardised protocol over a network. The user phrases a request for data. Software on his system consults a directory, locates the required data and submits a request to the system holding the data phrased in the designated protocol. This message is interpreted by the interface software and the requested data returned to the user's system, again in a standardised format.

At first glance, this seems an ideal system. Certainly, from the data requester's point of view it would seem to satisfy all his requirements. However, there are problems associated with such a scenario:

- a) Both systems described above are based upon Unix platforms connected via LANs or Internet. In order to provide data management support on an international basis all scientists would require access to such platforms, or at least to platforms operating some analogue of Unix daemons.
- b) Somebody has to code the necessary software interfaces. Considering the range of platforms and local data management strategies involved, this is no small task though the work involved would be reduced if PIs could be persuaded to standardise their local data management strategies. The question of who would undertake this work would also need to be addressed. It is doubtful whether all PIs would be willing, or even capable, of undertaking such software development.

As well as software interfaces, a directory needs to be maintained to tell the system where the individual components of the data are located. Presumably this would be undertaken by the PIs using directory maintenance utilities. These would be required for a range of platforms further increasing the software development requirement.

- c) Responsibility for the data has been delegated beyond the limits where it can reasonably be expected to be maintained. The primary responsibility of individual PIs is to their own research: services to the wider community are the results of good will.

This has a number of consequences. First, no-one assumes responsibility for forcing related data into a unified space time coordinate system. The discussion above clearly illustrates how this can give rise to problems: when the data are brought together from distributed sources they may not fit together. The scientist requesting data therefore finds himself with an unexpected workload if he is to produce a merged data set from its component parts.

Secondly, no-one assumes responsibility for guaranteeing availability of the data until they are no longer required. It is easy to imagine a PI running short of disk space on his home system and wiping data which he has finished with but are still required by others working on the project.

Thirdly, no-one takes responsibility for ensuring that consistency is maintained within the distributed data set. Thus, it would be perfectly possible for a request for chlorophyll-a data to return HPLC, fluorometric and spectrophotometric data: all would be perceived as chlorophyll-a by the scientist who collected the data.

Finally, no-one takes responsibility to ensure that the requesting scientist receives all the qualifying information required to ensure that the data are fit for his purposes.

#### **5.4 A Way Forward**

The previous section may appear damning. However, all of the criticisms result from the extension of distribution to the individual PI level. Consider a scenario of project data management by a number of small topical data centres, each responsible for assembling an online database from a clearly defined subset of the data collected during the project.

Linking these together with an object oriented distributed database management system provides, in the author's view, one the most exciting ways forward in international data management.

### **6 Conclusions**

The main aim of this paper has been to describe the workings of a topical data centre: a small group of data management professionals working symbiotically on a project with the research scientists.

In the case studies presented, a small team within BODC have achieved what can only be described as a major data management success. The scientists have benefited both from the removal of a significant data processing burden and in

increased data availability. BODC has benefited by obtaining a far more complete contribution to the national data archive than would otherwise have been possible and has acquired these data on a very short timescale.

The topical data centre model shows great promise for large scale project data management, particularly when interfaced to current developments in distributed database technology. However, if the data management of any project is to be successful, adequate resources specifically targeted at data management must be made available.

### **Acknowledgments**

This work described in this paper was only possible by the dedication and sheer hard work of a number of individuals. Polly Machin (BOFS) and Ray Cramer (North Sea Project) have made significant contributions as have the students (Mike Jones, Jeremy Ashley, Bill Cave, Steve Ng, Pete Brocklehurst, Mark Bell, Gareth Trevor and Andy Spiller) who have spent some of their time at BODC on the projects.

Mairi Marshall accurately keyed in numerous data sets submitted on paper. Other colleagues in BODC, particularly Lesley Rickards and Steve Loch, were always willing to lend a hand when the going got tough. Dave Neave taught SQL on both database courses.

I thank the director of BODC, Meirion Jones, for his sound advice and undying support. Last but not least, I thank the project scientists for their assistance and cooperation, without which the data management initiative would surely have failed.

### **References**

- Flierl, G. (1992) Data Management for JGOFS: Theory and Design. These proceedings.
- Loch, S.G. (in prep) An Efficient, Generalised Approach to Banking Oceanographic Data.
- Menke et al (1991). Sharing Data Over Internet with the Lamont View-Server System. *EOS* 72, pp 409-414.

## **Appendix 1**

### **Data Holdings in the North Sea and BOFS Project Data Bases**

#### **North Sea Project Data Summary**

- 70,000 nautical miles of underway data
- 3,800 CTD casts
- 10,000 water bottle samples
- 168 production experiments
- 749 net hauls
- 59 core stations

#### **North Sea Project Data in Detail**

##### **Underway Data**

Underway data for 38 cruises (30 from the main 1988/1989 field season plus 8 related cruises). These contain the following parameters sampled at 30 second intervals:

- Thermosalinograph temperature and salinity
- Fluorescence (calibrated as chlorophyll for most cruises)
- Optical attenuation (calibrated as suspended matter load for most cruises)
- Bathymetry

In addition, 20 of the cruises have dissolved oxygen logged at 15 or 5 minute intervals and 8 of the cruises have underway nutrient data at intervals of 30 minutes, 1 minute or 30 seconds.

In total, there are 1.37 million datacycles in this set which approximate to some 70,000 nautical track miles of data.

##### **CTD Data**

The database contains approximately 3,800 CTD casts. In addition to pressure, temperature and salinity each cast includes fluorescence (calibrated as chlorophyll for most cruises), dissolved oxygen and optical attenuation (calibrated as suspended matter load for most cruises) data. Over 3,000 of the casts also include upwelling and downwelling photosynthetically active irradiance data.

##### **Water Bottle Data**

The database contains data from over 10,000 water bottle samples. Of these nutrients were done on over 6,000, extracted chlorophylls and suspended matter on nearly 5,000, trace metals on over 1,700 and sulphur compounds and halocarbons on nearly 800.



### **Production Data**

The database contains 154 in-situ and 806 on-deck 14C primary production measurements, 118 thymidine bacterial production measurements and with 72 oxygen production measurements. These represent 144 14C experiments, 15 thymidine experiments and 9 oxygen experiments. each over a range of depths.

### **Plankton Species Distribution**

The abundances of 15 zooplankton classes are held for 749 net hauls. Phytoplankton species distributions are held for 59 stations.

### **Core Data**

The database contains pore water profiles, sedimentology and some nutrient flux data for 59 core stations.

### **BOFS Data Summary**

- 45,000 nautical miles of underway data
- 535 CTD casts
- 1,089 Seasoar profiles
- 90 XBT profiles
- 196 production experiments
- 105 phytoplankton species distributions
- 89 zooplankton samples
- 259 cores

### **BOFS Data in Detail**

#### **Underway Data**

Underway data for 11 cruises (3 in 1989, 6 in 1990 and 2 in 1991). These contain the following parameters sampled at 30 second or 1 minute intervals:

- Thermosalinograph temperature and salinity
- Fluorescence (calibrated as chlorophyll)
- Optical attenuation
- Bathymetry (4 cruises)
- Nutrients (7 cruises)
- Photosynthetically active radiation
- Solar radiation
- Wind velocity
- Air temperature
- Barometric pressure

In addition, on 5 cruises, dissolved oxygen was logged at 5 minute intervals and CO<sub>2</sub> parameters (pCO<sub>2</sub>, TC0<sub>2</sub>, pH and alkalinity) logged approximately every 10 minutes.

In total, there are 0.8 million datacycles in this set which approximate to over 45,000 nautical track miles of data.

### **CTD and Related Data**

The database contains 535 CTD casts. In addition to pressure, temperature and salinity each cast includes fluorescence (calibrated as chlorophyll), and optical attenuation. Over 75 per cent of the casts include upwelling and downwelling photosynthetically active irradiance data and about 50 percent have dissolved oxygen data.

The database also contains Seasoar (a towed undulator measuring temperature, salinity, dissolved oxygen and chlorophyll) from two cruises. These are held in the database as 1,089 pseudo CTD casts on a 4 km spacing loaded from a gridded data set.

Finally, there are 90 XBT profiles held in the database.

### **Water Bottle Data**

The database contains data from over 5,000 water bottle samples. Of these nutrients were done on over 2,700, extracted chlorophylls on over 2,000, DOC and CO<sub>2</sub> parameters on over 400, POC/PON on over 500, and pigments by HPLC on over 300.

### **Production Data**

The database contains 508 <sup>14</sup>C primary production measurements, 539 thymidine bacterial production measurements 134 (many with associated bacterial counts), oxygen production measurements (many with associated TCO<sub>2</sub> data) and 117 <sup>5</sup>N new production measurements. These represent 76 <sup>14</sup>C experiments, 68 thymidine experiments, 24 <sup>5</sup>N experiments and 28 oxygen/TCO<sub>2</sub> experiments, each over a range of depths.

### **Plankton Species Distribution**

Phytoplankton species distributions are held for 105 samples collected from 17 stations over a range of depths.

### **Zooplankton Biomass and Grazing**

The database holds data for 16 zooplankton grazing experiments, 89 biomass stations and 43 mesozooplankton gut content determinations.

**Core Data**

The database contains chemical, sedimentological and bioturbation (by radio-nuclides) data from 259 cores taken at 118 coring stations.

## **Management and Assimilation of Satellite Data for JGOFS**

---

***Robert Evans***

### **Summary**

Mr. Evans described the data flow that has been established and noted that understanding this flow was essential to understanding the data base. He noted that the complete suite of sensors as well as data transfers all need to be considered. This includes the process from initial satellite recordings to the final geophysical values that these represent. Further he illustrated the coordination that needs to be established between the satellite and field programs. Using SEAWIFS as an example, the usages and product delivery needs all must be considered. Presumed geophysical values must also undergo a quality assessment that involves in situ air and sea values. finally you wind up with suites of data and data products that are available in time scales from near-real time to months or even years later. It was noted that changes in algorithms, correction factors and calibration require that data be available for reanalysis at later dates.

Using AVHRR as an example, Mr. Evans showed the level of effort that was required in order to build this high quality time series data set, complete with error bars. This is the type of data that is most useful to climate studies but it required working and reworking buoy data used as sea truth and AVHRR data from satellites.

Finally the some of the critical elements required for a successful system were: Timely access, simple mechanisms which allow one to include all partners in a large project, allowance for metadata so users are aware of how product was derived and distributed system interfaces that readily accessible and easy to use.

## **The Continuous Plankton Recorder Survey: a Long-Term, Basin-Scale Oceanic Time Series.**

---

*John C Gamble and Harold G Hunt*

### **Introduction**

In the 1920s, before the advent of echosounders, fishery biologists were greatly concerned with assisting the fisherman to locate schools of pelagic fish. One of the approaches they developed was to relate the distribution of the planktonic food organisms to the presence of the schools of predators such as herring (*Clupea harengus*). The British planktologist, Alister Hardy, who had already carried out extensive studies on the feeding preferences of herring (Hardy, 1926a), initiated a programme to examine the fishermen's contention that herring schools avoided "green", i.e., phytoplankton-rich, water but could be correlated with high concentrations of zooplankton.

This practical programme was centred on the use of a specially developed instrument, the "Plankton Indicator", designed to be used by the fisherman to assist in the search for suitable waters. It had limited success in its main aim but, as a collecting device, it embodied several profoundly important features. It was a simple instrument which was robust enough to be deployed and recovered by the crew of commercial vessels (in this case fishing vessels) while they were underway.

The Indicator however, was no more than a high speed net which integrated the plankton over the area of sampling, but Hardy had also become interested in describing the patchiness of planktonic populations. He thus developed the Continuous Plankton Recorder (CPR) where he substituted the fixed filter screen of the Indicator by a continually moving length of silk mesh. The screen traversed at constant speed across the path of the incoming water and the trapped organisms were retained in place by sandwiching beneath an additional second mesh screen (Fig 1). Thus, knowing the speed of the towing vessel and the shooting and hauling positions, the spatial patterns of the plankton could be determined. Hardy took the first CPR to the Antarctic where he used it in the Southern Atlantic (Hardy, 1926b) and later deployed it in the North Sea to make some of the earliest contiguous records of plankton patchiness.

### **The Development of the CPR Survey**

Hardy was not content with the mere description of the linear patchiness of plankton along a tow track, he was intrigued by the broader spatial patterns of plankton distributions and the temporal changes which occurred. He thus conceived the idea of deploying CPRs more or less simultaneously behind several

towing vessels and, using the analogy of meteorological investigations of that time, would thereby gain a synoptic picture of temporal and spatial change in plankton populations. In his words "the idea underlying the initiation of this ecological survey was that of attempting to apply methods similar to those employed in meteorology to the study of the changing plankton distribution, its causes and effects" (Hardy, 1939). An improved version of the CPR was developed, the MK II, which incorporated an adjustable propeller to compensate for different towing speeds of commercial "ships of opportunity", had improved gearing and a mechanism to minimise the flattening of the captured organisms by the sandwiching silk meshes. A CPR Survey team was set up and a series of routes were developed in the North Sea between Britain and continental Europe. (Fig 2).

The present CPR survey was thus established over 60 years ago and, since then, has had a somewhat chequered history. It stopped operations during World War II, reached its zenith between 1965-1975 (Fig 3), nearly ceased in 1989 and became the responsibility of an independent Foundation in 1991. When reestablished after the War, sampling routes were developed to the west of Britain as well as across the North Sea. Initially routes were established to several weather ships in the eastern Atlantic with the first trans-Atlantic deployment, via Iceland to Newfoundland, taking place in 1959. At its height, in 1970, the CPR Survey included 4 trans-Atlantic Routes though, of these, only the UK-Iceland-Newfoundland-Cape May route remains (Fig 4). CPRs have been towed about 3.8 million nautical miles since the inception of the Survey, not including those deployed by NOAA/NMFS in the USA and CSIRO in Australia.

Until 1989 the Survey was financed directly by the UK government although occasional awards were made by other bodies such as the ONR of the USA and the Canadian Fisheries Department. Since April 1991 the Survey has been the responsibility of a new organisation, the Sir Alister Hardy Foundation for Ocean Science (SAHFOS), which is an independent UK charity specifically formed to ensure the continuity of the CPR Survey and to promote and develop new long-term planktonic time series. SAHFOS is funded by an international consortium consisting of Canada, France, Iceland, Netherlands, United Kingdom, USA, the Council of European Communities and the Intergovernmental Oceanographic Commission.

## **Operations and Practices**

The CPR used in 1991 has changed little from that designed by Hardy in the 1930s. There have been derivatives, which will be mentioned below, but the paramount need to maintain the integrity of the long-term database has necessitated an extremely conservative policy against unwarranted change. The same silk mesh size of 280 $\mu$ m is used, it traverses the sampling tunnel at the same rate and the Recorder is still towed at a nominal 10 m depth. Each sample, collected at a range of speeds between 10-24 knots, represents 10 nautical miles of tow equivalent to 3 m<sup>3</sup> of water. As the main aim is to investigate the changing patterns of

plankton populations, 391 different taxonomic entities are routinely identified (Table 1). In addition a "green-ness" index is estimated which relates to the amount of chlorophyll leached out of phytoplankton by the formaldehyde preservative and which subsequently stains the silk threads of the mesh.

Instrumentation for the CPRs has been developed (Aiken, 1980) and robust, self-contained packages can be attached to Recorders which can measure temperature, salinity, fluorescence, depth, downwelling and upwelling light at several wavelengths, transmittance and other parameters. Hardy himself realised that there were severe limitations to sampling at a single depth, the vertical migration of many of the zooplankton species being one, and he hoped that a vertically resolving Recorder would eventually become available (Hardy, 1956). This is now possible with the development of the Undulating Oceanographic Recorder (Aiken, 1985) which samples sinusoidally between the surface and 70 m and is capable of carrying both the instrumentation package and the CPR internal silk mesh sampling mechanism. It has been towed behind ships of opportunity (Robinson et al., 1986), but only when accompanied by scientific staff, hence it has not been deployed routinely on CPR tow routes.

Operationally the CPR Survey is a continuous exercise which breaks down into the usual four component parts of most scientific investigative operations: sample collection, sample analysis, data handling and data evaluation. The major procedural aspect is that all the processes occur simultaneously. At present SAHFOS operates 15 CPR routes on a monthly basis amounting to about 60,000 miles for the year. Sample collection currently requires the 360 shipments of CPR bodies between Plymouth and various ports each year.

Sample analysis consists of the routine systematic identification and enumeration of, usually, each alternate 10 miles of sampling along a given route. Analysis is carried out directly on cut lengths of silk representing 10 miles of tow. Large organisms are analysed by eye, mesozooplankton and phytoplankton at set microscope magnifications. The aim since the inception of the Survey has been to match consistency with efficient throughput of samples and the basic analytical techniques have not changed since the early 1960s (Rae, 1952 and Colebrook, 1960, 1964). Organisms are not counted but are assigned abundance categories which quickens the analytical procedure but does not, with an experienced analyst, lead to significant loss of precision (Colebrook 1960). Data are stored as abundance categories which are subsequently transformed,  $\log(x+1)$ , so as to standardise variances in subsequent averaging processes before being collated for evaluation.

Data handling procedures in the CPR Survey have evolved alongside the development of the laboratory computer with the database and retrieval systems being elaborated up as computer systems became more sophisticated. Currently the CPR database (including storage and access programs) extends to 64.4 Mb and recently has almost completely been transferred from a mainframe computer to an OS/2- based PC. The main data archive is file-based made up of four files

annually. The first file contains navigational data and the length of silk filter mesh used for each tow. A second contains the sampling information for each tow detailing position (latitude, longitude and allocated "standard rectangle"), time, day or night and date. The third and fourth contain the plankton information for the tows made in a specific year; one with January to June data and the other the July to December data. Each tow within the files has been allocated a limited set of the sampling attributes; standard CPR rectangle co-ordinates and day or night allocation. The plankton information is held as coded abundance categories (see above).

The data for individual or grouped taxonomic entities can be retrieved in three ways:

1. Based on 1° latitude by 2° longitude "standard rectangles". The main use of the data extracted in this way is for producing distribution charts for biogeographical studies.
2. Based on defined groups of the standard rectangles into "standard areas" and used in the main for the analysis of large-scale variation in time and space. Such data has been used recently in the interpretation of possible effects of climatic/hydrographic interactions on plankton populations.
3. Based on any defined set of polygons (usually rectangles) which are most suitable for fine resolution analysis in restricted areas.

## Results of the Survey

Over 400 publications have either resulted directly from the Survey or make substantial use of its data since its inception. Essentially the data evaluations fall into three broad perspectives; biogeographical, (including the recognition of new species), seasonal cycles and long-term, interannual trends. Biogeography can be divided into distributional mapping (a comprehensive atlas of North Atlantic and North Sea plankton was published by the Edinburgh Oceanographic Laboratory in 1973) and short-term changes relating to hydrography. The CPR Survey, for instance, established the spatial differentiation of the congeners *Calanus finmarchicus* and *C. helgolandicus* (Matthews, 1967) in the North Atlantic (Fig 5). On a smaller scale there has been evidence of hydrographic incursions of Atlantic water into the North Sea as indicated by the recent increased prevalence of the predominantly Atlantic species, *Corycaeus anglicus* and *Metridia lucens* (Fig 6). These findings are supported by recent observations of exceptionally high salinity water in the northern North Sea in the winter of 1990-91 (Heath et al, 1991). The presence of doliolids in the German Bight of the North Sea in 1989 was further evidence of the same hydrographic event (Lindley et al, 1990). In some cases CPR observations have preceded hydrographic confirmation although the reverse has also been true, as the mid 1970 salinity anomaly in the North Sea has been used retrospectively to interpret CPR trends (J.M. Colebrook, pers. comm.).

In the context of JGOFS, it is appropriate to look at some of the CPR data in the vicinity of the recent UK BOFS operation around 60°N and 20°W. The time



series of CPR data in each of the standard areas straddling this study site extend for 43 years in C5 to the east but only 8 years in the adjacent C6 to the west. The basic data, shown for C5 (Fig 7), which clearly shows the seasonal pulses, can be averaged into representative seasonal cycles for the two areas (Fig 8). It is apparent that there are differences in the trophic structure of the planktonic systems in the two areas. During the peak bloom period the more westerly area appeared to have less abundant grazing zooplankton populations and higher phytoplankton. It could be inferred that there would be an increased sink of ungrazed phytoplankton-fixed CO<sub>2</sub> to the west of the study site. The greater proportion of grazing zooplankton in the east would presumably result in a greater level of metabolic remineralisation of CO<sub>2</sub>.

The short turnover time of planktonic trophic systems together with their inherent dependence on hydrographic conditions should make them ideal, rapid indicators of the effects of climate change. Two recent observations from the CPR Survey illustrate the consequences of both short and long-term climatic events on plankton populations.

Between 1986 and 1988 the abundance of several large species of dinoflagellates, *Ceratium* spp increased dramatically in the north-central North Sea (Fig 9). The preferred explanation for this increase (Dickson et al., in press) was that an anomalous south-easterly air stream had caused less saline water from the Baltic to spread away from its usual location close by the coast of Norway to cover a large area of the northern North Sea. The resultant stratification of the water column was highly favourable to the growth of the *Ceratium* spp. Recently this theory has been supported by information in Fraedrich and Müller (1992) which suggest that the south-easterly anomaly was a far reaching consequence of ENSO events being experienced in the eastern Atlantic.

Perhaps the most significant climatic aspect of the CPR time series is the recently evident change in the long term trends in abundance of groups of about 40 species of phytoplankton and zooplankton. Coherent patterns appear in the long term averages in each of 12 different areas suggesting in itself that pervasive factors relating to major atmospheric circulation events are involved in determining what happens to the plankton. Arguments have been presented which involve implicating changes in both westerly (Colebrook 1986) and northerly (Dickson et al., 1988) wind patterns but interest has now shifted to a possible response of plankton to the current trend in global warming.

Figure 10 illustrates time-series for zooplankton and phytoplankton in the North Sea. Until the early 1980s the trend in both planktonic groups was consistently downwards, indeed concern was once expressed that such effects might have resulted from anthropogenic impact, but the trend, particularly in the zooplankton, has increased consistently since then. Comparable parallel trends are evident in the long-term variability of the position of the North Wall of the Gulf Stream (Taylor et al, in press), in changes in an index of coastal upwelling in the Atlantic (Bakun, in press) and in annual averages of North Atlantic water (Folland

and Parker, 1990) and global air temperatures (Kerr, 1990). Moreover, similar parallels have been drawn between North sea plankton, the abundance of herring and the breeding success of piscivorous seabird populations on the north east coast of Britain (Aebischer et al, 1990) indicating that pervasive changes affect several different trophic levels of the ecosystem. Such implications can only be drawn from correlations and more years of observation are required before the links with climate can be established with more certainty although the indications are presently becoming evident.

### Literature Cited

- Aebischer, N.J., Coulson, J.C. And Colebrook, J.M. 1990. Parallel long-term trends across four marine trophic levels and weather. *Nature*, Lond, 347, 753-755.
- Aiken, J. 1980. A marine environmental recorder. *Mar. Biol.*, 57, 238-240.
- Aiken, J. 1985 The Undulating Oceanographic Recorder Mark 2. A multiple oceanographic sampler for mapping and modelling the biophysical marine environment. In: Zirino, A (ed) Mapping strategies for Chemical Oceanography. *American Chemical Society*, 315-332.
- Bakun, A (in press) Global greenhouse effects, multi- decadal wind trends, and potential impacts on coastal fish populations. ICES Variability Symposium, Mariehamn, 1991
- Colebrook, J.M. 1960. Continuous Plankton Records: methods of analysis, 1950-1959. *Bull. mar. Ecol.*, 5, 51-64.
- Colebrook, J.M. 1964. Continuous Plankton Records: a principal components analysis of the geographical distribution of zooplankton. *Bull. mar. Ecol.*, 6, 78-100.
- Colebrook, J.M. 1986. Environmental influences on long- term variability in marine plankton. *Hydrobiologia*, 142, 309-325.
- Dickson, R.R., Colebrook, J.M and Svendsen, E. (in press) Recent changes in the summer plankton of the North Sea. ICES Variability Symposium, Mariehamn, 1991
- Dickson, R.R., Kelly, P.M., Colebrook, J.M., Wooster, W.S. And Cushing, D.H. 1988. North winds and production in the eastern north Atlantic. *J. Plankton Res.*, 10, 151-169.

- Edinburgh Oceanographic Laboratory. 1973. Continuous Plankton Records: a plankton atlas of the North Atlantic and the North Sea. *Bull. mar. Ecol.*, 7, 1-174
- Folland, C.K. and Parker, D.E. 1990, Observed variations of sea surface temperature. In: Schlesinger, M. (ed). *Proc. NATO Adv. Wkshp*, Oxford 1988, 21-52
- Fraedrich, K. and Müller, K., 1992, Climate anomalies in Europe associated with ENSO extremes. *Int. J. Climatol.*, 12, 25-31
- Hardy, A.C., 1926a, The herring in relation to its inanimate environment, Pt II. MAFF Fish. Invest. Ser. ii, VIII, No.7.
- Hardy, A.C. 1926b. A new method of plankton research. Appendix II. In S.Kemp, *The Discovery Expedition. Nature*, Lond., 118, 630-632.
- Hardy, A.C. 1939. Ecological investigations with the Continuous Plankton Recorder: summary list of records, 1932-1937. *Hull. Bull. mar. Ecol.*, 1, 59-71.
- Hardy, A.C. 1956. *The Open Sea, Its Natural History. Part I: The World of Plankton*, Collins, London, 335 pp.
- Heath, M., Henderson, E.W., Slesser, G. and Woodward, E.M.S. 1991. High salinity in the North Sea. *Nature*, Lond. 352, 116.
- Kerr, R.A. 1990. Global warming continues in 1989. *Science*, 247, 521
- Lindley, J.A., Roskell, J., Warner, A.J., Halliday, N.C., Hunt, H.G., John, A.W.G. and Jonas, T.D. 1990. Doliolids in the German Bight in 1989: evidence for exceptional inflow into the North Sea. *J. mar. biol. Ass. U.K.*, 70, 679-682.
- Matthews, J.B.L. 1967. *Calanus finmarchicus* s.l. in the north Atlantic. The relationships between *Calanus finmarchicus* s.str., *C. glacialis* and *C. helgolandicus*. *Bull. mar. Ecol.*, 6, 159-179.
- Rae, K.M. 1952. Continuous Plankton Records: explanation and methods, 1946-1949. *Hull Bull. mar. Ecol.*, 3, 135-155.
- Robinson, G.A., Aiken, J. and Hunt, H.G. 1986. Synoptic surveys of the western English Channel. The relationships between plankton and hydrography. *J. mar. biol. Ass. U.K.*, 66, 201-218.
- Taylor, A.M., Colebrook, J.M., Stephens, J.A. and Baker, N.G. (in press) Latitudinal displacements of the Gulf Stream and the abundance of plankton in the N.E. Atlantic. *J. mar biol. Ass. UK*

**Table 1. Summary of taxonomic entities identified routinely in the Continuous Plankton Recorder Survey**

	Phytoplankton	Zooplankton
Species	119	118
Genus	42	63
Family	1	6
Sub-Order	1	3
Order	-	16
Class	2	14
Phylum	-	6
Total	165	226

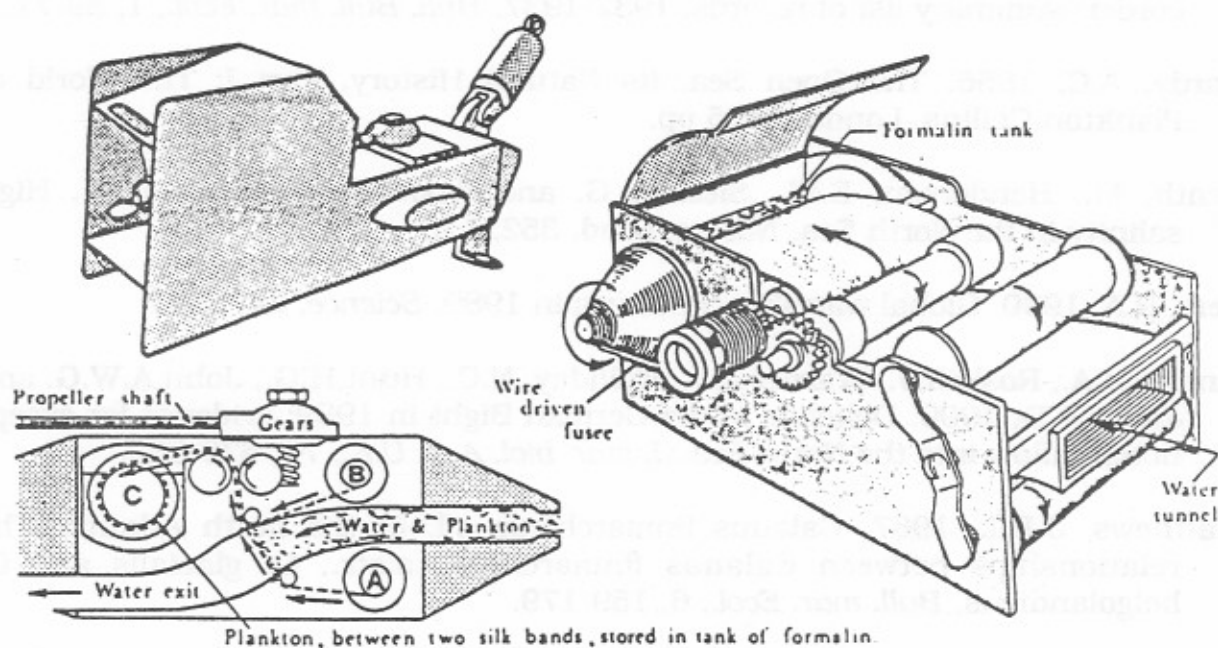

Figure 1. Schematic representation of the Continuous Plankton Recorder. The entire instrument is approximately 1 m in length.

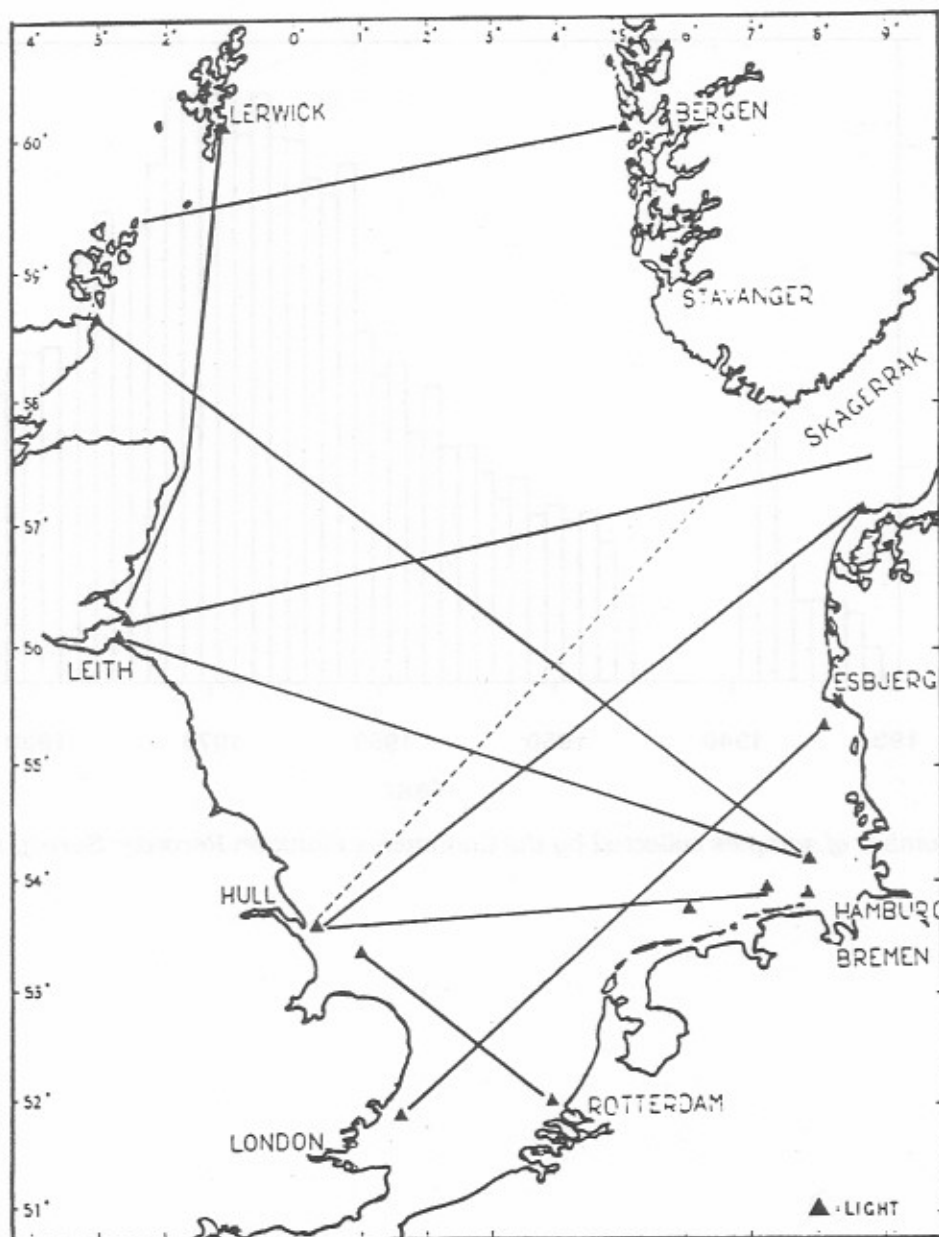

Figure 2. Monthly Continuous Plankton Recorder Survey routes in the North Sea in 1938 from Hardy, 1939).

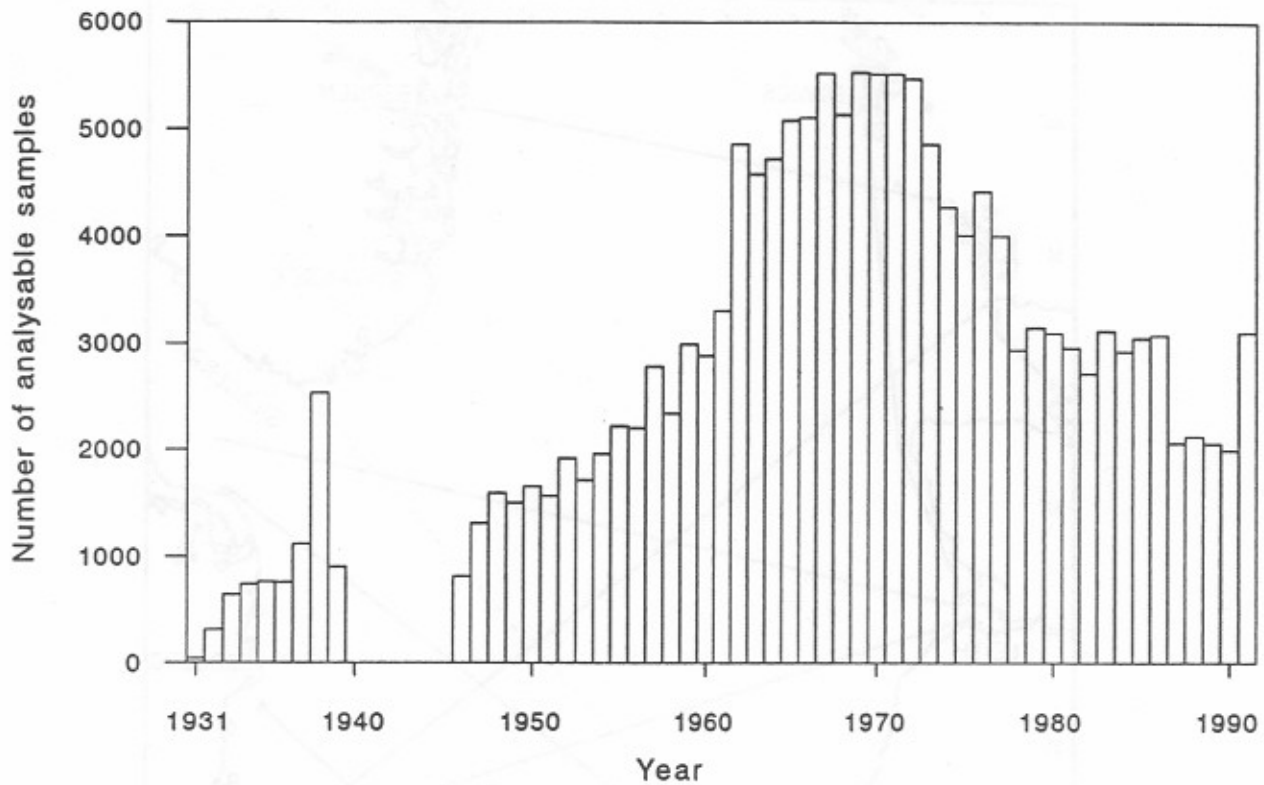

Figure 3. Number of samples collected by the Continuous Plankton Recorder Survey since 1931.

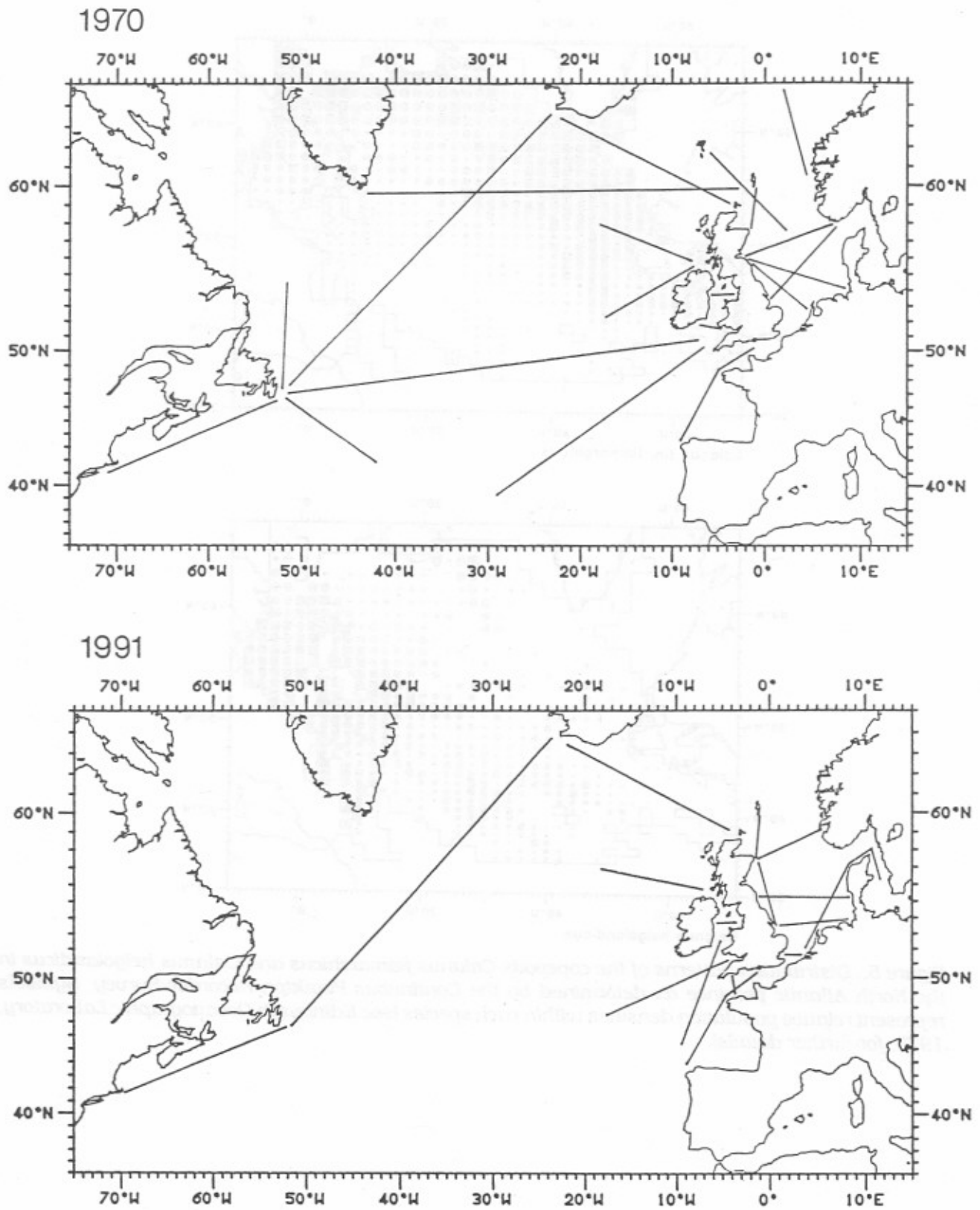

Figure 4 . Tow routes of Continuous Plankton Recorders in 1970 and 1991.

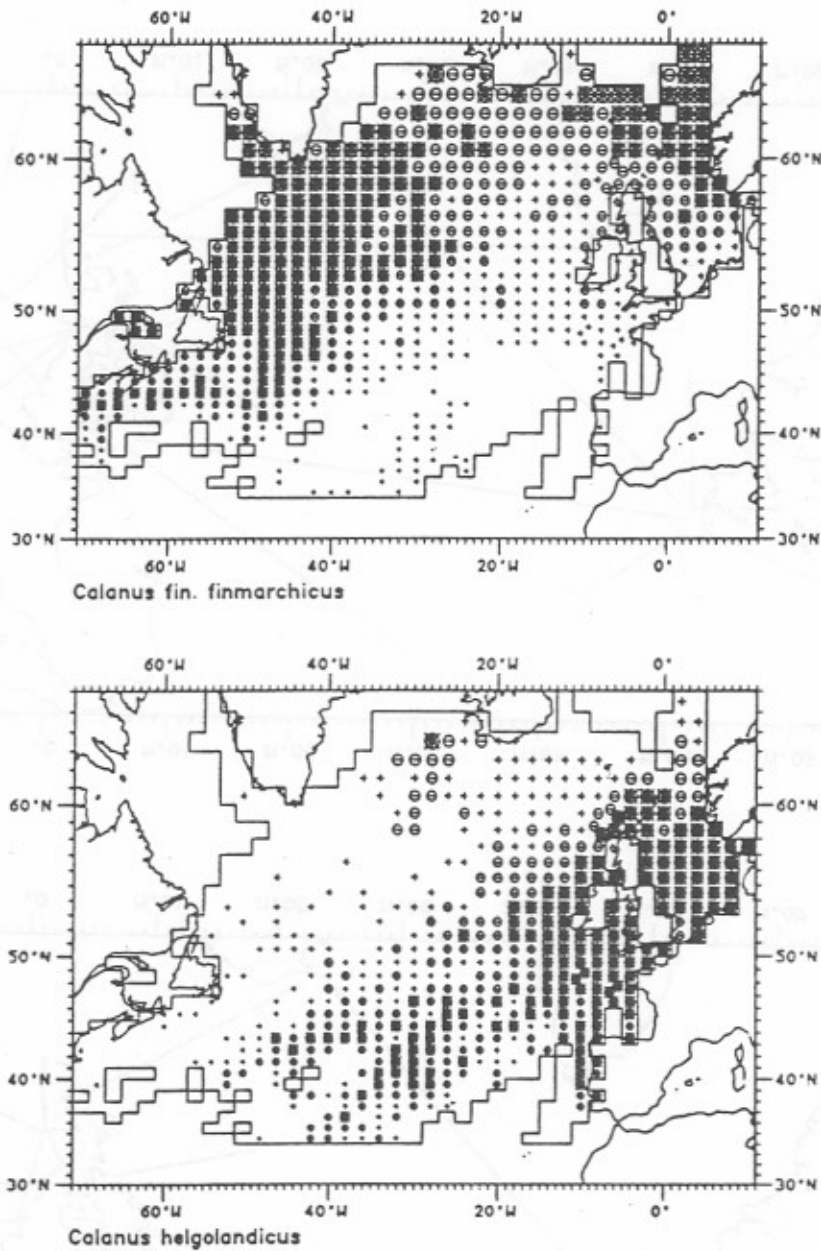

Figure 5. Distribution patterns of the copepods *Calanus finmarchicus* and *Calanus helgolandicus* in the North Atlantic province as determined by the Continuous Plankton Recorder Survey. Symbols represent relative population densities within each species (see Edinburgh Oceanographic Laboratory, 1973, for further details).



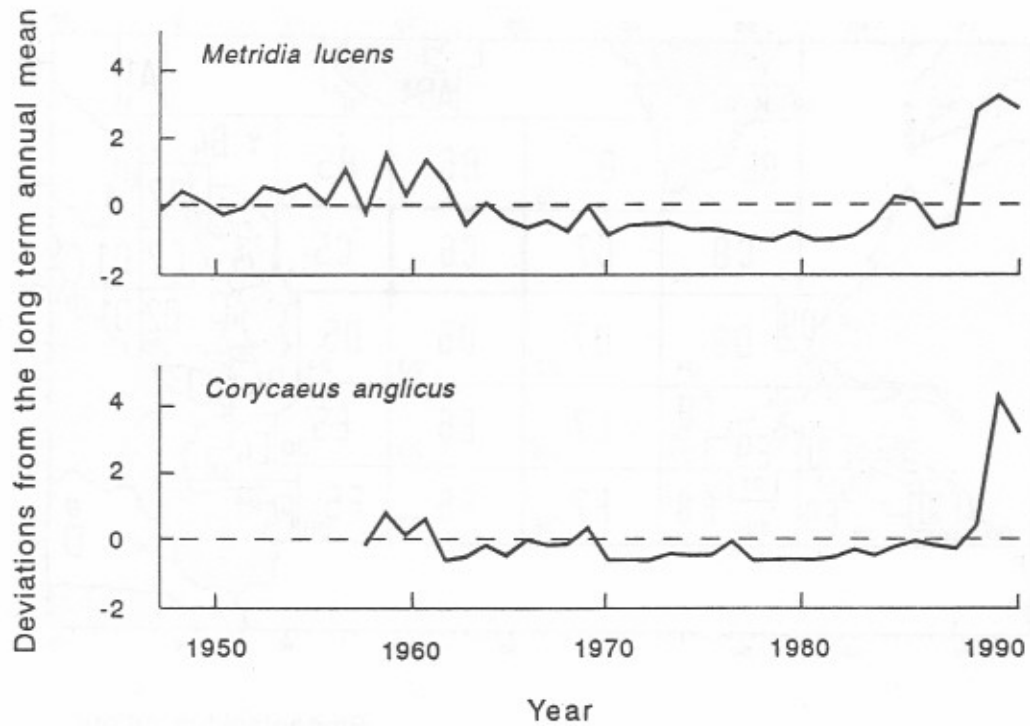
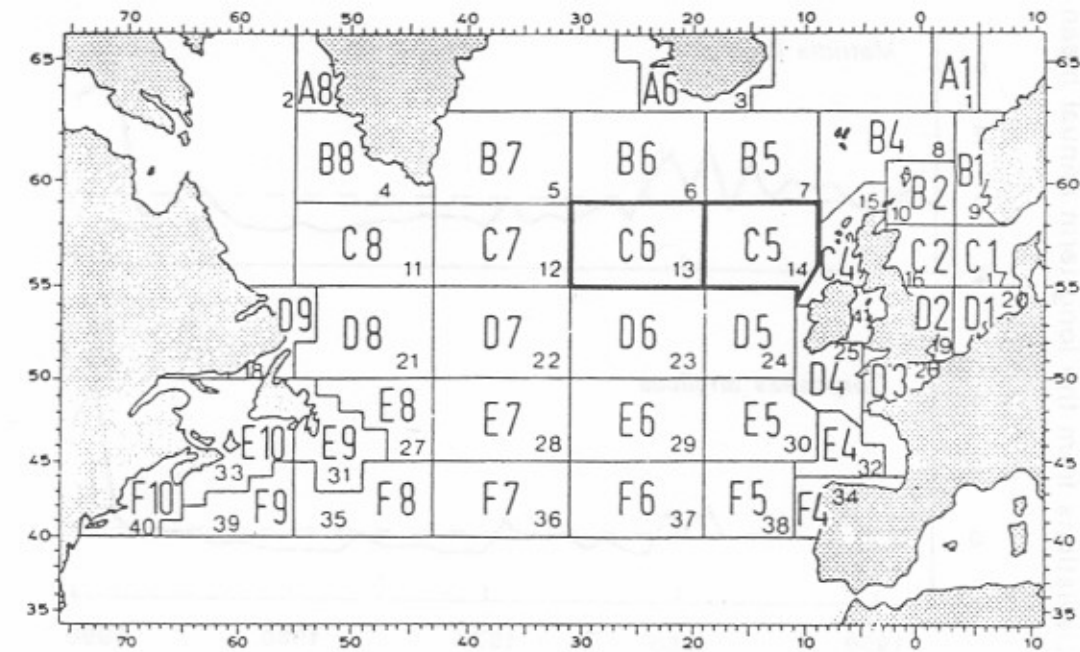
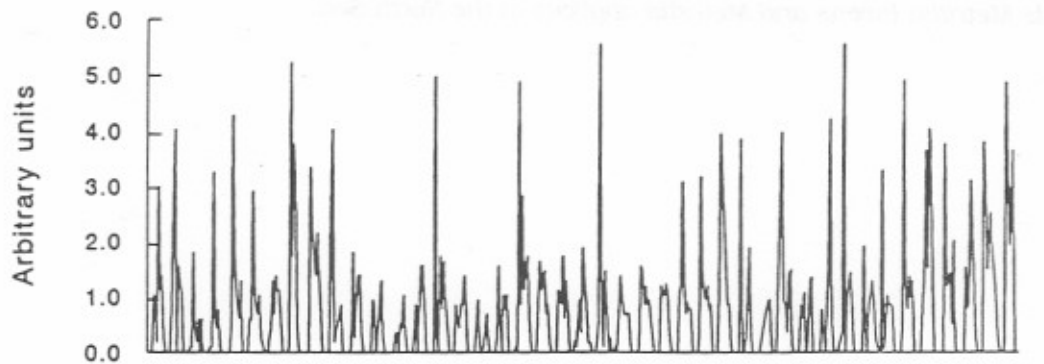

Figure 6. Summaries of the long term fluctuations in the abundance (in standard deviation units) of the copepods *Metridia lucens* and *Metridia anglicus* in the North Sea.



Phytoplankton colour



Total copepod abundance

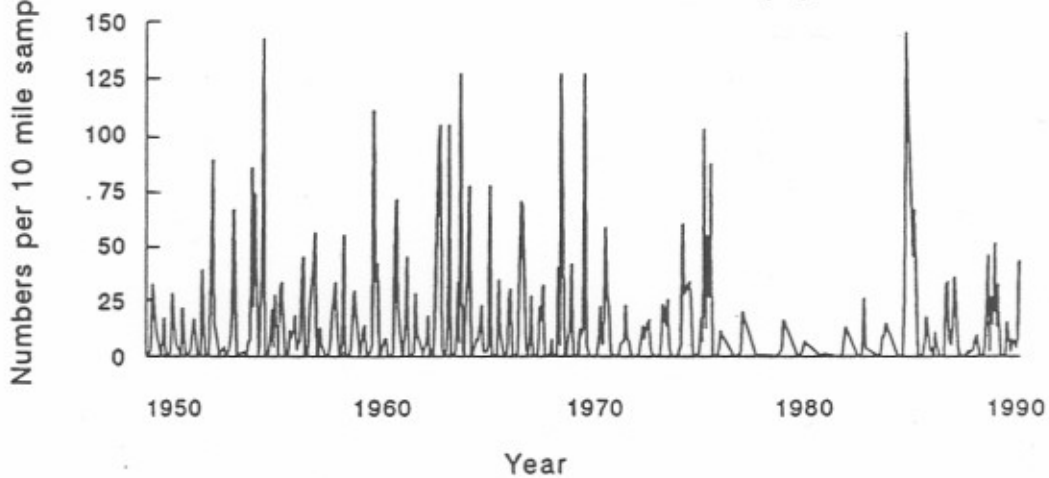

Figure 7. Annual variation in phytoplankton colour index and total copepod abundance in the NE Atlantic area C5 situated to the north west of the British Isles.

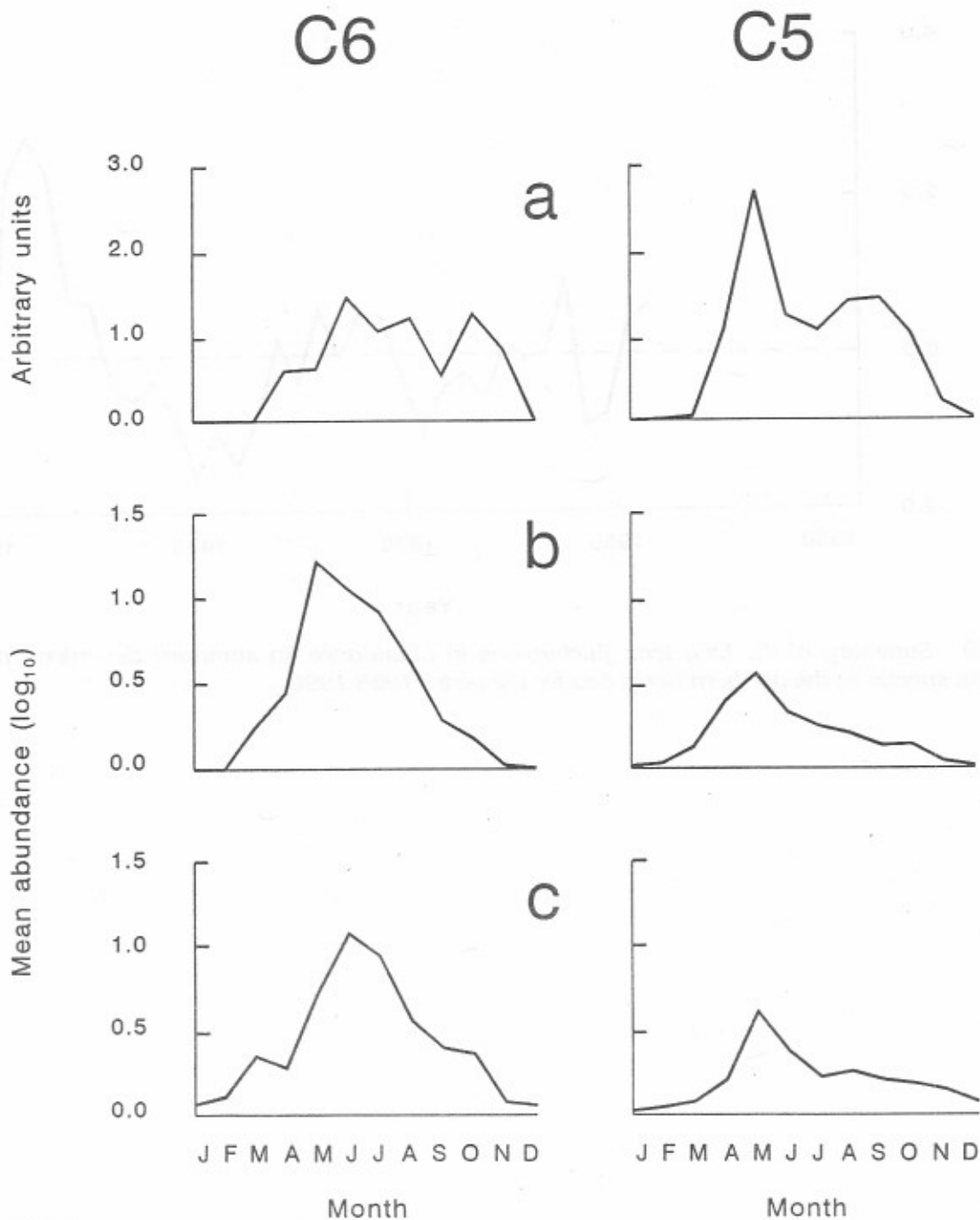

Figure 8. Averaged seasonal variation in (a) the phytoplankton colour index, (b) abundance of *Calanus finmarchicus* and (c) abundance of *Euphausiacea* in the NE Atlantic areas C5 and C6 (see Figure 7).

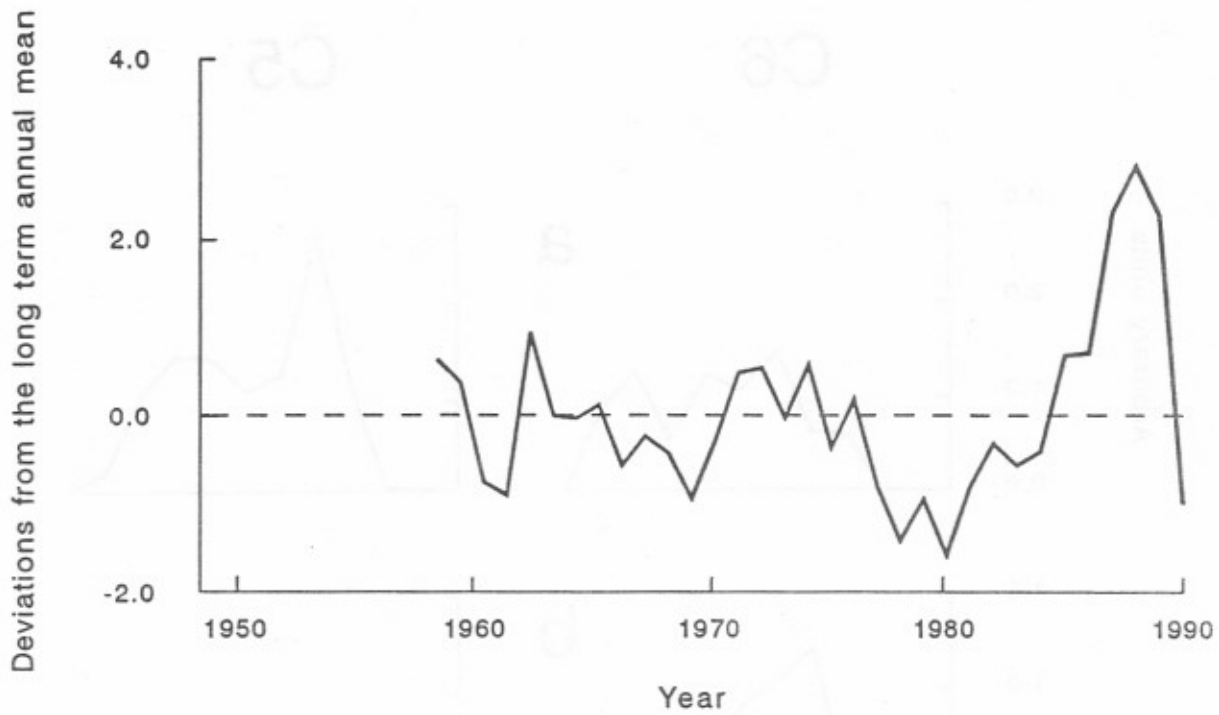

Figure 9. Summary of the long term fluctuations in abundance (in standard deviation units) of *Cerattium* species in the northern North Sea for the years 1958-1990.

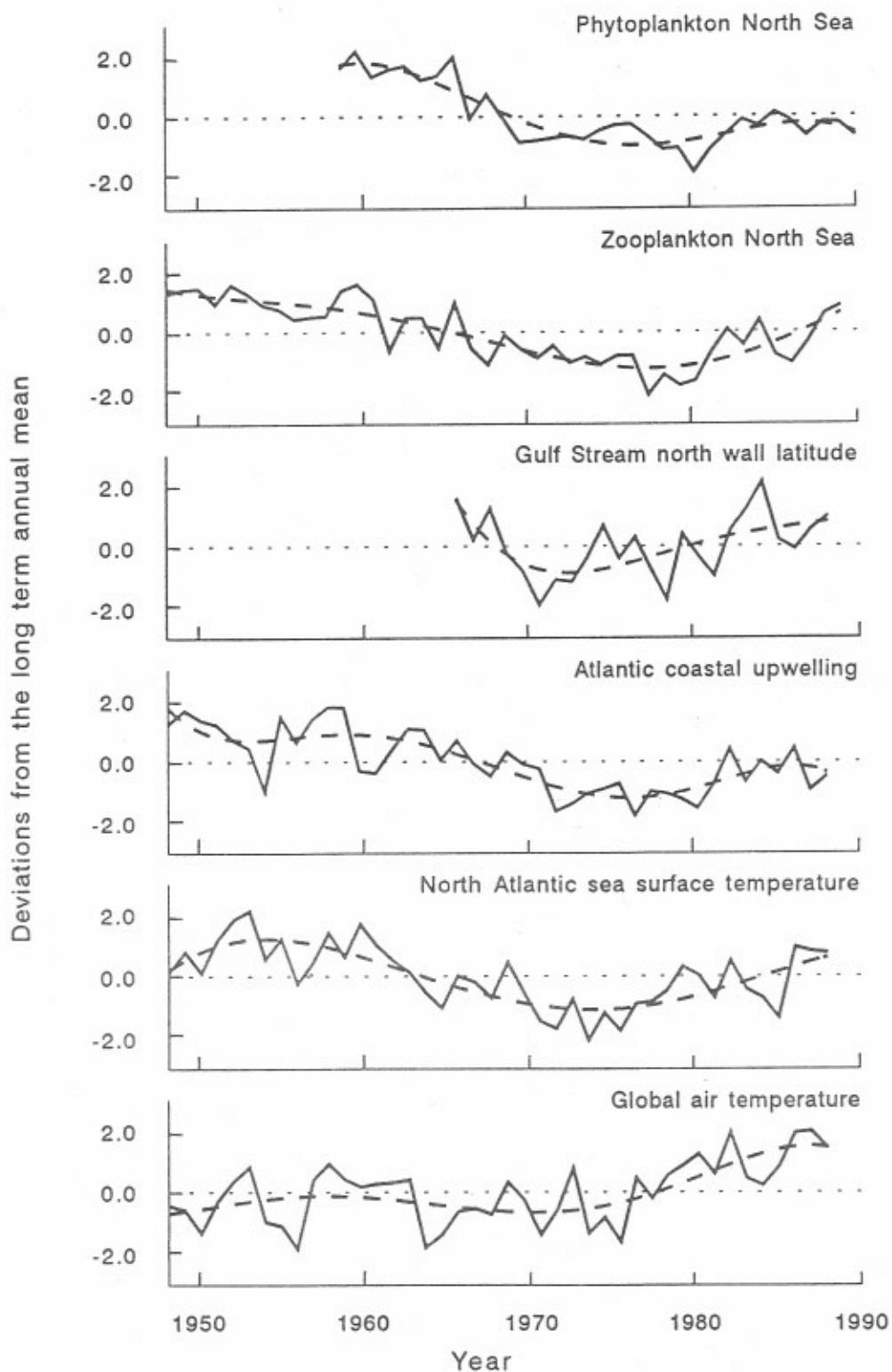

Figure 10. Summaries of the long term fluctuations in the abundance (in standard deviation units) of phytoplankton and zooplankton in the North Sea compared to long term indices of hydrographic and temperature changes.

# Ocean Time-Series Near Bermuda: Hydrostation S and the U.S. JGOFS Bermuda Atlantic Time-Series Study

---

*Anthony F. Michaels and Anthony H. Knap*

## Abstract

Bermuda is the site of two ocean time-series programs. At Hydrostation S, the ongoing biweekly profiles of temperature, salinity and oxygen now span 37 years. This is one of the longest open-ocean time-series datasets and provides a view of decadal scale variability in ocean processes. In 1988, the U.S. JGOFS Bermuda Atlantic Time-series Study began a wide range of measurements at a frequency of 14-18 cruises each year to understand temporal variability in ocean biogeochemistry. On each cruise, the data range from chemical analyses of discrete water samples to data from electronic packages of hydrographic and optics sensors. In addition, a range of biological and geochemical rate measurements are conducted that integrate over time-periods of minutes to days. This sampling strategy yields a reasonable resolution of the major seasonal patterns and of decadal scale variability. The Sargasso Sea also has a variety of episodic production events on scales of days to weeks and these are only poorly resolved. In addition, there is a substantial amount of mesoscale variability in this region and some of the perceived temporal patterns are caused by the intersection of the biweekly sampling with the natural spatial variability. In the Bermuda time-series programs, we have added a series of additional cruises to begin to assess these other sources of variation and their impacts on the interpretation of the main time-series record. However, the adequate resolution of higher frequency temporal patterns will probably require the introduction of new sampling strategies and some emerging technologies such as biogeochemical moorings and autonomous underwater vehicles.

## Introduction

Oceanic ecosystems exhibit variability on a wide range of time and space scales (Dickey, 1991, this volume). This variability is caused by a combination of physical and biological processes and has important consequences for the measurement and interpretation of the upper ocean carbon cycle. The most obvious temporal pattern is the seasonal variation in ocean mixing and phytoplankton primary production. Interannual variations in these seasonal patterns provide natural experiments on the relationship between the physical forcings and the biological response. Thus, long-term time-series observations provide a powerful tool for investigating biogeochemical processes in the ocean.

In 1988, the Bermuda Atlantic Time-series Study (BATS) was initiated as part of the U.S. Joint Global Ocean Flux Study (U.S.JGOFS) program. This station is one of two NSF funded time-series efforts in JGOFS, the second is the Hawaii Ocean Time-series Station (HOTS). The purpose of BATS and HOTS is coincident with the larger goals of JGOFS, namely "... to determine and understand ... the processes controlling the time-varying flux of carbon and associated biogenic elements in the ocean ..." (SCOR 1987). The focus of the BATS and HOTS efforts is on understanding the "time-varying" components of the ocean carbon cycle. The overall program is a mixture of traditional time-series monitoring of ocean processes and the application of specific process-oriented studies of ocean biogeochemistry within the time-series framework.

Bermuda is the site of numerous time-series investigations. One of the most prominent is the biweekly hydrographic sampling at Hydrostation S started by Henry Stommel and coworkers in 1954 (Schroeder and Stommel, 1969). This is one of the longest running ocean time-series operations in the world. From 1957-1963, this hydrographic study was supplemented by a program of biological and chemical measurements to determine the seasonal cycle of ocean production (Menzel and Ryther, 1960, 1961). This 5 year program provided the first detailed study of oceanic biogeochemistry in the Sargasso Sea. The data are still widely cited and reused to address hypotheses on the magnitude and controls of oceanic production (e.g., Platt and Harrison, 1985, Fasham et al., 1990). In addition to Hydrostation S, there is a 13 year time-series of deep-ocean sediment trap collections (Deuser, 1986) and a 12 year time-series of atmospheric measurements through the WATOX and AEROCE programs. This rich time-series history and these diverse existing measurement programs provide a valuable framework for the near-surface biogeochemistry investigations in the BATS program.

In this paper, we report on some of hydrography, oxygen, nutrients, pigments and particulate organic carbon and nitrogen and production rate data for the first three years of the BATS program. The data for the first two years are published elsewhere and discussed in greater detail (Michaels, submitted). These data illuminate some of the mechanisms that lead to the annual spring bloom in the Northern Sargasso Sea (Menzel and Ryther, 1960, 1961). In addition, the oxygen and nutrient data were used to provide independent estimates of the rates of new production associated with the 1989 spring bloom. We present new data on high-frequency variability in the time-series records that are likely due to mesoscale eddies. We also present some direct observations of these mesoscale features that indicate that both horizontal and vertical processes are involved in the delivery of nutrients to the surface. These unresolved features will require new and expanded sampling strategies and technologies to be resolved adequately. The BATS data provide important guidelines for the development of future time-series programs, particularly in the context of an extensive program like the proposed Global Ocean Observing System (GOOS)

## Methods and Materials

Hydrographic sampling at Station S (Figure 1) began in 1954 with the routine measurement of temperature, salinity and oxygen at 24 depths (0-2600 m). Traditionally, temperature was measured using reversing thermometers, salinity by conductivity (recently with a Guildline, AutoSal) and oxygen by Winkler titration. Since 1988, these measurements have been made using the same methods as for the BATS station.

The Bermuda Atlantic Time-series Study (BATS) commenced monthly sampling in October, 1988 near the site of the Ocean Flux Program (OFP) station located 70 km southeast of Bermuda (Figure 1). This station is the present site of Dr. Werner Deuser's (WHOI) long-term deep-sea sediment trap mooring (Deuser, 1986). Cruises were conducted aboard the R.V. *Weatherbird*, R.V. *Cape Henlopen* and the R.V. *Weatherbird II*. On each BATS cruise, a free-drifting sediment trap array is deployed approximately 7 km southeast of OFP and all of the hydrocasts are started near this array. The 400 m array typically drifts between 10 and 50 km (occasionally 150 km) during the three-day deployment. The configuration of this array is described in Lohrenz, et al. (1992). On each cruise, hydrocasts and water bottle collections are made at 36-48 depths during a series of 4-7 casts from the surface to 4200 m. Details of the sampling scheme, analytical methods and quality control procedures are available in the BATS Methods Manual and data reports (Knap, 1991, 1992) and summarized below.

A Sea-Bird CTD with additional sensors was used to measure continuous profiles of temperature, salinity, dissolved oxygen, downwelling irradiance, beam attenuation and in situ fluorescence. This instrument package was mounted on a 12 position General Oceanics Model 1015 rosette that was typically equipped with twelve, 12 l Niskin bottles. The salinity and dissolved oxygen concentrations as calculated from the CTD sensors were calibrated with the discrete salinity and oxygen measurements collected from the Niskin bottles on the rosette (Michaels et al., submitted).

Water samples for oxygen, salinity and nutrient analyses usually were collected in teflon-coated Niskin bottles on the General Oceanics rosette. The oxygen samples were collected first. They were drawn into individually numbered, 115 ml BOD bottles and analyzed using the Winkler titration chemistry. Whenever possible, the samples were titrated with an automated titrator and endpoint detection system (MetrOhm 655 Dosimat, Oxygen Auto-Titrator). The duplication of oxygen samples at every depth allows a routine check on the precision of the oxygen measurement. Oxygen saturation was calculated from the Weiss algorithms (Weiss, 1970). Salinity samples were drawn after the gas samples and analyzed within 1 week of collection on a Guildline AutoSal 8400A salinometer. The samples were standardized to IAPSO Standard Seawater regularly during each sample run. Samples for nitrate+nitrite and phosphate were filtered with Whatman GF/F filters and frozen. Samples for silicate were filtered through 0.4  $\mu\text{m}$  Nucleopore



filters and refrigerated at 4°C. The samples were analyzed within two weeks using traditional colorimetric techniques (Strickland and Parsons, 1972).

Chlorophyll samples were filtered onto 25 mm GF/F filters, frozen in liquid nitrogen and analyzed by both fluorometric and HPLC techniques. Particulate organic carbon and nitrogen samples were filtered onto precombusted GF/F filters, dried and acidified under vacuum then analyzed on a Control Equipment Corp. 240-XA Elemental Analyzer and standardized using acetanilide as a reference standard.

Primary production is measured by the uptake of  $^{14}\text{C}$  in dawn to dusk in situ incubations. All the sampling employs trace-metal clean procedures. Incubations usually are conducted at 8 standard depths (20 m vertical spacing) in the upper 140 m. Details of the primary production methods are found in the BATS methods manual and in Lohrenz, et al., 1992)

## Results

The time-series data at BATS are presented as time vs depth contour plots for some of the measured parameters (Figures 2-7). Surface seawater values were variable and showed an obvious seasonal pattern of winter mixing and a resultant spring bloom. The depth of the mixed layer showed a spring maximum in all three years and was followed by a rapid stabilization to a shallow summer mixed layer. Despite this similarity, there were significant differences between years in the intensity of winter mixing with 1989 and 1991 significantly stronger than 1990. These interannual differences are reflected in the biological parameters.

During the February 1989 spring bloom, oxygen concentrations were supersaturated from the surface to 250 m depth, whereas, in December 1988, the water was under saturated with oxygen at all depths. Following the 1989 bloom, oxygen anomalies continued to increase in the stratified surface waters and decreased below saturation in the lower euphotic and upper mesopelagic zones. Nutrient concentrations in the upper euphotic zone were uniformly low during most of the year. During the 1989 bloom sampling, the concentration of nitrate+nitrite in the mixed layer reached values of 0.5 to 1.0  $\mu\text{moles/kg}$ . Phosphate and silicate concentrations did not show a seasonal increase during this period. During the winter and spring of 1990, the oxygen concentration in the mixed layer was always above saturation. Despite the 170 m mixed layer, which should have entrained water with measurable nutrients, nitrate+nitrite was near the detection limit of 0.05  $\mu\text{moles/kg}$  during the spring 1990 cruises. There was some depletion of nitrate between 100 and 150 m during the February 1990 cruise in the period of deepest mixing. The bloom in 1991 was of similar intensity to that in 1989, but lasted for a much longer period of time. Oxygen concentrations were slightly above saturation early in the bloom and increased as it progressed. As with 1989, the supersaturation extended to the base of the 200 m mixed layer. There was measurable nitrate in the euphotic zone for over three months.

In addition to the spring mixing events, there were small surface maxima in nitrate+nitrite concentrations in September, October and November 1989. These elevated surface nutrients may be due to rainfall inputs from summer storms and hurricanes, although they occurred after the summer minimum in salinity. Coincident with these surface nutrients, there were anomalously high nutrients near 60 m in both October and November, 1989.

Each spring bloom was characterized by the presence of elevated stocks of chlorophyll a, particulate organic carbon (POC) and particulate organic nitrogen (PON, Figures 5-7). Despite the relatively recent mixing, the concentration of chlorophyll a in February 1989 was a factor of 10 higher than the upper euphotic zone chlorophyll concentration the rest of the year. By the next sampling period (March 26, 1989), the subsurface chlorophyll maximum had descended to 100 m. This maximum became less pronounced through the summer. Particulate organic carbon and nitrogen were also elevated by a factor of 10 at the surface during the 1989 bloom. As with chlorophyll, the surface POC and PON returned to typical values by March. However, unlike the chlorophyll, POC and PON did not show a marked subsurface maximum.

The spring bloom in 1990 also was characterized by elevated concentrations of chlorophyll a and particulate organic matter between February and April, 1990. The peak 1990 chlorophyll concentration was 40% of the peak 1989 value of 0.5  $\mu\text{g}/\text{kg}$ . Peak POC and PON concentrations were 20-35% lower than the peak values in 1989.

The bloom in 1991 was very different in the pattern of particulate materials. Although the chlorophyll concentration does increase to values of greater than 0.5  $\mu\text{g}/\text{kg}$ , this increase happens in the June-September period, well after the depletion of nutrients. Particulate organic carbon and nitrogen peak values are more synchronous with the nutrient depletion and again, are concentrated near the surface.

The rate of phytoplankton primary production as measured by the uptake of  $^{14}\text{C}$  also shows a seasonal pattern synchronous with the winter mixing (Figure 8). However, the seasonal variations in the production rates are at odds with the relative strength of each bloom as interpreted from the intensity of the mixing. The period of high production is short in 1989 (a single cruise) while it is more prolonged during 1990, the winter with the shallowest mixed layer. Production in spring 1991 is the highest of the three spring periods, but again, elevated production lasts past the period of nutrient inputs. In addition, there are periods of high production during the late summer, traditionally thought to be a time of low production. The June-July production peaks in 1989 are before the anomalous surface nutrients observed that fall. The high production in 1990 lasts much of the fall period and is not accompanied by observable nutrient inputs.

### **Short-term Variability in Phytoplankton Community Composition**

The HPLC pigment data indicated major differences in phytoplankton community structure between biweekly cruises in 1990 (Figure 9a-l, also see Michaels et al., submitted). The interpretation of these pigment profiles is presented in detail elsewhere (Michaels et al., submitted). The important feature for the purposes of this paper are the large variations in the vertical structure of different pigments between the cruises. Each of these pigments is characteristic of one or more groups of phytoplankton. For example, in early May, the chlorophyll b peak at 100 m was associated with elevated zeaxanthin concentrations at the same depth, suggesting the presence of prochlorophyte-like phytoplankton. In early April, there is no corresponding zeaxanthin peak at 100 m, indicating the chlorophyll b was associated with eukaryotic chlorophytes and/or prasinophytes, and not prokaryotic prochlorophyte-like phytoplankton. Some pigments, (fucoxanthin, chlorophyll c1+2, chlorophyll c3, diadinoxanthin and diatoxanthin) were present throughout the bloom period. Sometimes they co-occurred with 19'-hexanoyloxyfucoxanthin and 19'-butanoyloxyfucoxanthin, suggesting that prymnesiophytes and chrysophytes (respectively) were present. At other times, elevated levels of fucoxanthin, diadinoxanthin and diatoxanthin concentrations were observed without high levels of 19'-hexanoyloxyfucoxanthin and 19'-butanoyloxyfucoxanthin, a possible indication of diatom-dominated blooms.

### **Horizontal Heterogeneities in Nitrate**

In November, 1991, we occupied a grid of 20 stations (4 by 5 grid) 20 minutes apart in both longitude and latitude (Figure 10) and made profiles of hydrography and nutrients. There was considerable spatial heterogeneity in these profiles, even on the same density surface. Figure 10a shows the nitrate concentration on the 26.16 sigma-theta density surface and figure 10b shows the depth of that density surface. There are changes of more than 1 mmol/kg over horizontal distances of 15-30 km. At some of these locations, this density surface changes depth by as much as 40 m in the vertical over the same horizontal scale. There will be eddy diffusion of nutrients along these gradients on the isopycnal surface and in some cases, the depth changes of the surface will cause a vertical nutrient flux by isopycnal mixing.

### **Discussion**

The data collected through the U.S JGOFS, Bermuda Atlantic Time-series Study (BATS) can be used to provide guidance on the development of future ocean time-series programs and the Global Ocean Observing System. These data illustrate some of processes that control the upper ocean carbon cycle and the temporal and spatial complexities of even an oligotrophic ocean environment. When coupled with the 37 year Hydrostation S record, they also indicate the substantial problems of determining long-term secular trends in a complex and

variable ocean. More detailed interpretations of these data will be presented elsewhere (Michaels, et al., submitted). Here, we examine the importance of these sampling issues for the creation and interpretation of a time-series program.

The first 36 months of data collected in the Bermuda Atlantic Time-series Study show the marked seasonality that was initially described by Menzel and Ryther (Menzel and Ryther, 1960, 1961) and is evident in the analyses of the 37 year Hydrostation S record (e.g. Jenkins and Goldman, 1985). It seems likely that the seasonal aspects of the data do reflect the larger scale temporal patterns of ocean biogeochemical processes. The higher resolution pigment data indicate either that there is a great deal of high-frequency community evolution at this site, or, more likely, that there is a complex mesoscale eddy field that is being randomly sampled by the BATS program. This horizontal complexity is also evident from the 20 station grid of profiles that show variation in nutrient profiles on density surfaces.

### Surface Ocean Seasonal Pattern

Menzel and Ryther (1960, 1961) first documented the seasonal pattern of mixing, biomass and production in the Sargasso Sea at Hydrostation S, 45 km northwest of the BATS site. Surface cooling and wind mixing in the winter and spring caused the formation of a mixed layer that eroded into the nutrient rich layers below the euphotic zone and introduced those nutrients into the euphotic zone. These nutrients then stimulated a bloom of phytoplankton and a period of increased primary production which lasted from 1 to 3 months. They noted substantial interannual variability in the timing and intensity of the bloom (Menzel and Ryther, 1961), which they related to variations in the intensity of deep mixing in the winter. The marked seasonality of the ocean near Bermuda is now firmly established from the 37 year Hydrostation S record. Jenkins and Goldman (1985) analyzed an 18 year portion of this record. There is a significant decadal scale variability in the record with a period of lower ventilation in the mid 1970's bracketed by periods of strong ventilation in the early 1960's and the late 1970's (Jenkins and Goldman, 1985). A more recent analysis shows that the early 1980s were a period of very low ventilation with winter mixed layers of less than 80 m (Figure 11). In the late 1980s (1983-1989), leading up to the BATS sampling, the mixed layers of approximately 150 m were shallow compared to the historical values.

New production is defined as the phytoplankton primary production supported by the uptake of exogenous nutrients (Dugdale and Goering, 1967) primarily nitrate in ocean systems. Over time scales where steady state assumptions are appropriate, the amount of new production will be equal to the exports of organic nitrogen from the euphotic zone, either from sinking particles (Eppley and Peterson, 1979), downward mixing of DON (Jackson, 1988, Toggweiler, 1990) or the vertical migration of zooplankton (Longhurst and Harrison, 1988). At the BATS station, new production rates have been estimated by the changes in oxygen and nitrate

concentrations during the February 1989 bloom (Michaels, et al., submitted). These rates were 19-44 % of the annual average new production of 0.5 moles N/m<sup>2</sup>/yr estimated by Jenkins and Goldman (1985). The estimates of new production in this single event also equal or exceed the annual particle export as estimated by short-term sediment trap deployments (Lohrenz, et al., 1992) at the same station. With both nitrate and oxygen, these are underestimates of the new production associated with this event. Similar short-term production events are also noticeable in the BIOWATT mooring data from a location west of Bermuda (Dickey, 1991). Clearly, if it is actually a product of temporal variation, spring bloom events like this one would account for a significant proportion of the annual new production.

These blooms occur nearly every year with substantial interannual variability in intensity of the deep mixing. The mixing in 1989 was less than the long-term average (Figure 11). The intensity of deep-winter mixing and the depth of the mixed layer should both be related to the amount of biological new production that occurs. As in 1989, this winter mixing probably accounts for the majority of the annual new production. The accurate characterization of these blooms in both time and space will be required to assess the annual rates of regional new production. A more highly resolved temporal sampling may be necessary to understand the biological and physical mechanisms that determine the timing and magnitude of the bloom. The complete characterization of the carbon and nitrogen systems will also be required, in particular, the currently unknown stocks of dissolved organic matter.

### **Spatial Variability**

Both the high-frequency pigment profiles and the 20 station grid in November 1991 shed light on some of the difficulties of making and interpreting time-series measurements in a heterogeneous ocean. Every cruise in spring 1990 measured a different phytoplankton community. If the changes on phytoplankton community structure was truly a temporal pattern, it would indicate a very dynamic system. However, it is much more likely that these short-term changes are the intersection of our sampling program with the natural spatial variability in this region. We may be sampling a different eddy on each cruise. Thus these higher frequency data are difficult to interpret as a coherent time-series.

The 20 station grid shows much the same feature. There are significant changes in the nutrient fields over spatial scales of 10's of kilometers. These data also indicate that there are processes that are not resolved adequately with one-dimensional sampling programs. Calculations of the vertical supply of nutrients by diapycnal mixing and isopycnal mixing along the tilted isopycnal surfaces suggest that at times, most of the nutrient supply to the base of the euphotic zone come from isopycnal mixing. The 4-5 order of magnitude differences in the vertical gradients is balanced by the 4-6 order of magnitude differences in eddy diffusivities. A full understanding of the time-varying nutrient fluxes that control the ocean

carbon cycle will require that all of the important processes be resolved. Creation of time-series sampling programs will require consideration of these issues and the application of appropriate sampling strategies to cover the appropriate scales for each region.

### **Suggestions for the Future**

The BATS sampling program yields a consistent view of the large-scale seasonal patterns in the upper ocean carbon cycle. Between the BATS and Hydrostation S sampling programs, there are approximately hydrographic 40 cruises each year to the area southeast of Bermuda. Yet, despite this intense sampling effort, it is apparent that some important biogeochemical features are not resolved adequately. The spatial heterogeneity of the environment causes some aliasing of the temporal signal. In addition, there are some processes that are fundamentally horizontal, such as the isopycnal nutrient inputs to the euphotic zone that cannot be resolved with a one-dimensional time-series program.

There are new and emerging ocean sampling technologies that may significantly improve our resolution of ocean variability and resolve some of the time and space scales that alias a traditional time-series program. Moorings can provide very high resolution temporal signals to show the contribution of low frequency, short-duration events (see Dickey, this volume). Satellites provide extensive spatial and temporal coverage of near surface properties with some weather limitations. Autonomous Underwater Vehicles (AUV) allow for repeated, high-frequency three-dimensional surveys of a region (see Dickey, this volume). AUVs have the additional advantage that water samples can be routinely returned to the laboratory for analysis. This expands the range of measurements that can be made with an AUV compared to truly remote technologies (i.e. moorings). However, for many measurements, there are still no appropriate remote sensors and human beings and ships will be required.

Prior to the establishment of a time-series sampling program, estimates must be made of the temporal and spatial scales that are important for the scientific questions of the study and for the specific region of study. Logistical constraints must also be considered. From this information, a sampling strategy can be determined that both addresses the scientific questions and resolves the relevant temporal and spatial scales. For some environments and questions, a truly one-dimensional approach may be appropriate and some combination of moorings and traditional hydrographic sampling could be employed. In heterogeneous areas, satellites and three-dimensional mapping using AUVs or ships would be required. The required frequency of sampling as determined from the temporal scale of the processes might determine the choice of traditional ship-board sampling or autonomous vehicles. In all of these decisions, logistics (especially distance to the station and availability of a research vessel) and costs must be taken into account so that the sampling strategy yields the most relevant information for the cost.

The existing US.JGOFS Time-series stations in Bermuda and Hawaii are valuable examples of the power and potential of time-series observations for addressing globally important questions. Understanding the patterns and controlling processes of temporal changes in ocean biogeochemistry is a necessary component of any attempt to understand the role of the oceans in global processes. These stations are also natural test beds for the development of remote technologies for time-series research. Efforts to test and evaluate mooring and AUV technologies at the US.JGOFS Time-series stations are part of the future plans for these sites and some efforts have already begun. These simultaneous validations of remote and traditional technologies are an important first step in developing the sampling strategies that will be the heart of a Global Ocean Observing System.

### **Acknowledgments**

We thank Rachel Sherriff-Dow, Rodney Johnson, Kjell Gundersen, Jens Sorensen, Ann Close, Frances Howse, Margaret Best, Melodie Hammer, Nick Bates, Jennifer Verduin and the crews of the R.V. Weatherbird I, R.V. Henlopen and R.V. Weatherbird II for their collecting and analyzing the samples and for their valuable assistance and support. Bill Jenkins, Jim Swift, Steve Emerson, Tom Hayward and George Heimerdinger served on a U.S. JGOFS Time-series Oversight Committee. This group provided many valuable suggestions to improve data quality and we are very grateful. We acknowledge the support of NSF through the grants OCE-8613904 and OCE-8801089 to AHK, OCE-9017173 and OCE-9016990 to AFM and BSR-9018298 to RRB. This is BBSR Contribution number 1316. The processed data from the Bermuda Atlantic Time-series Study (BATS) are available as data reports through the U.S.JGOFS Planning Office (Woods Hole Oceanographic Institution, Woods Hole, MA 02543, USA). Upon request, a diskette containing the CTD profiles and all of the discrete data can be acquired from George Heimerdinger at the National Ocean Data Center (NODC, Woods Hole Oceanographic Institution) or the authors of this paper.

### **References**

- Deuser W. G. (1986). Seasonal and interannual variations in deep-water particle fluxes in the Sargasso Sea and their relation to surface hydrography. *Deep-Sea Res.*, 33, 225-246.
- Dickey T. D. (1991). The emergence of concurrent high-resolution physical and bio-optical measurements in the upper ocean and their applications. *Review of Geophysics*, 29, 383-413.
- Dugdale, R.C. and J.J. Goering (1967). Uptake of new and regenerated forms of nitrogen in primary productivity. *Limnology and Oceanography*, 12, 196-206.

- Eppley, R. W. and B. W. Peterson (1979). Particulate organic matter flux and planktonic new production in the deep ocean. *Nature*, 282, 677-680.
- Fasham, M. J. R., H. W. Ducklow and S. M. McKelvie (1990). A nitrogen-based model of plankton dynamics in the oceanic mixed layer. *Marine Research*, 48, 591-639.
- Jackson, G. A. (1988). Implications of high dissolved organic matter concentrations for oceanic properties and processes. *Oceanography*, 1, 28-33.
- Jenkins, W. J. and J. C. Goldman (1985). Seasonal oxygen cycling and primary production in the Sargasso Sea. *J. Mar. Res.*, 43, 465-491.
- Knap, A. H., A. F. Michaels, R. L. Dow, R. J. Johnson, K. Gundersen, G. A. Knauer, S. E. Lohrenz, V. A. Asper, M. Tuel, H. Ducklow, H. Quinby and P. Brewer (1991). U.S. Joint Global Ocean Flux Study. Bermuda Atlantic Time-Series Study. Data Report for BATS 1-BATS 12 October, 1988-September, 1989, U.S. JGOFS Planning Office, Woods Hole.
- Knap, A. H., A. F. Michaels, R. L. Dow, R. J. Johnson, K. Gundersen, A. Close, G. A. Knauer, S. E. Lohrenz, V. A. Asper, M. Tuel, H. Ducklow, H. Quinby and P. Brewer (1992). U.S. Joint Global Ocean Flux Study. Bermuda Atlantic Time-Series Study. Data Report for BATS 13-BATS 24, October, 1988-September, 1989, U.S. JGOFS Planning Office, Woods Hole.
- Lohrenz, S. E., G. A. Knauer, V. L. Asper, M. Tuel, A. F. Michaels and A. H. Knap (1992). Seasonal and interannual variability in primary production and particle flux in the northwestern sargasso Sea: U.S. JGOFS Bermuda Atlantic Time Series. *Deep-Sea Research* (In press).
- Longhurst, A. R. and W. G. Harrison (1988). Vertical nitrogen flux from the oceanic photic zone by diel migrant zooplankton and nekton. *Deep-Sea Res.*, 35, 881-889.
- Martin, J. H., G. A. Knauer, D. M. Karl and W. W. Broenkow. (1987) VERTEX: carbon cycling in the northeast Pacific. *Deep-Sea Res.*, 34, 267-285.
- Menzel, D. W. and J. H. Ryther (1960). The annual cycle of primary production in the Sargasso Sea off Bermuda. *Deep-Sea Res.*, 6, 351-366.
- Menzel, D. W. and J. H. Ryther (1961). Annual variations in primary production of the Sargasso Sea off Bermuda. *Deep-Sea Res.*, 7, 282-288.
- Michaels, A. F., A. H. Knap, R. L. Dow, K. Gundersen, R. J. Johnson, J. Sorensen, A. Close, G. A. Knauer, S. E. Lohrenz, V. A. Asper, M. Tuel, and R.R. Bidigare (submitted). Ocean time-series measurements off of Bermuda: The first two



years of the U.S.JGOFS Bermuda Atlantic Time-series Study. *Deep-Sea Research*.

Schroeder, E. AND H. Stommel (1969). How representative is the series of Palinuris stations of monthly mean conditions off Bermuda? *Progress in Oceanography*, 5, 31-40.

Scor (1987). The Joint Global Ocean Flux Study: Background, Goals, Organization and Next Steps, Report of the International Scientific Planning and Coordination Meeting for Global Ocean Flux Studies, Paris, 2/17-19/87. SCOR, Dalhousie University, Halifax, Nova Scotia, Canada. 42 pp.

Strickland, J. D. H. and T. R. Parsons (1972.) A practical handbook of seawater analysis. 167 pp.

Toggweiler, J.R. (1989). Is the downward dissolved organic matter (DOM) important in carbon transport? In: Berger, W.H., V.S. Smetacek and G. Wefer (eds) Productivity of the oceans: Past and present. Wiley and Sons Ltd. pp 65-83.

Weiss, R. F. (1970). The solubility of nitrogen, oxygen and argon in water and seawater. *Deep-Sea Research*, 17, 721-735.

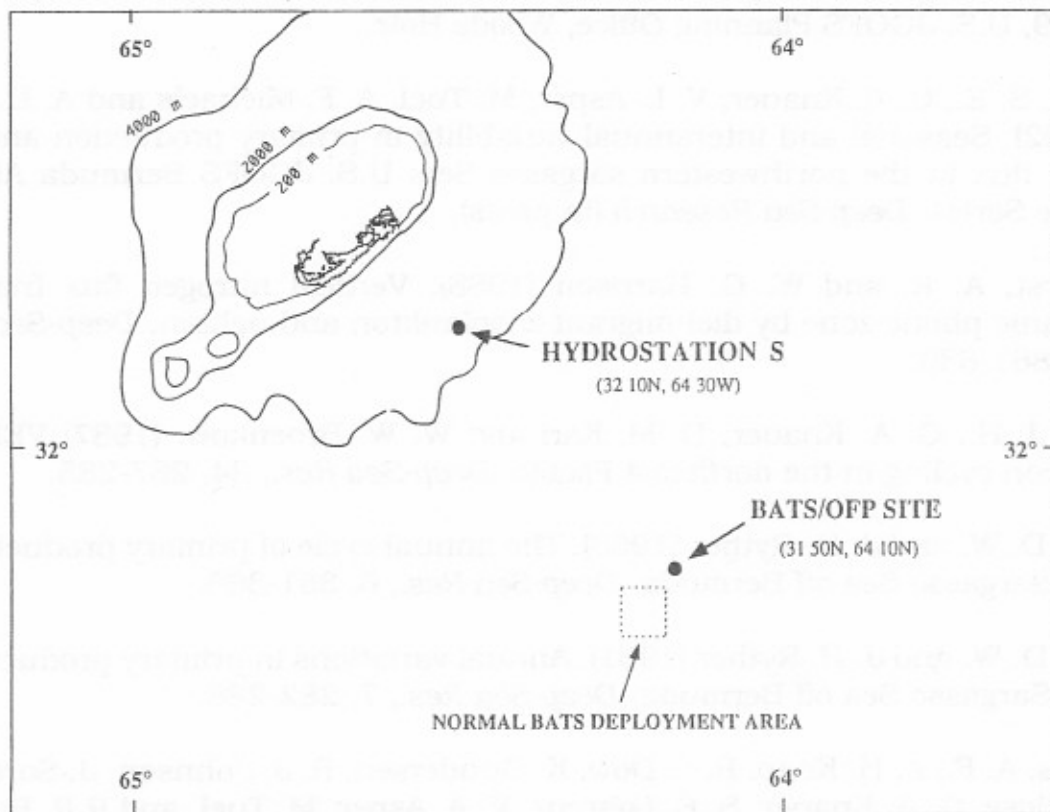

Figure 1. Map of Bermuda and the surrounding waters illustrating the location of the Bermuda Atlantic Time-series Study (BATS) site and the site of the Hydrostation S sampling (1954-present).

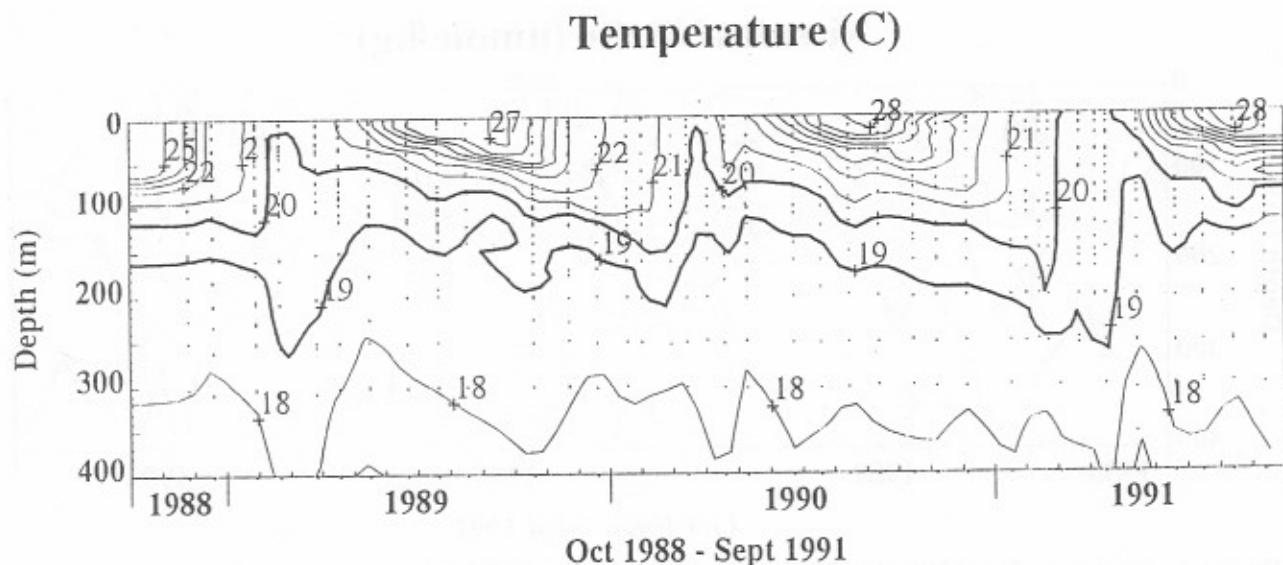

Figure 2. Contour plot of potential temperature ( $^{\circ}\text{C}$ ) at the BATS site during the first three years of sampling.

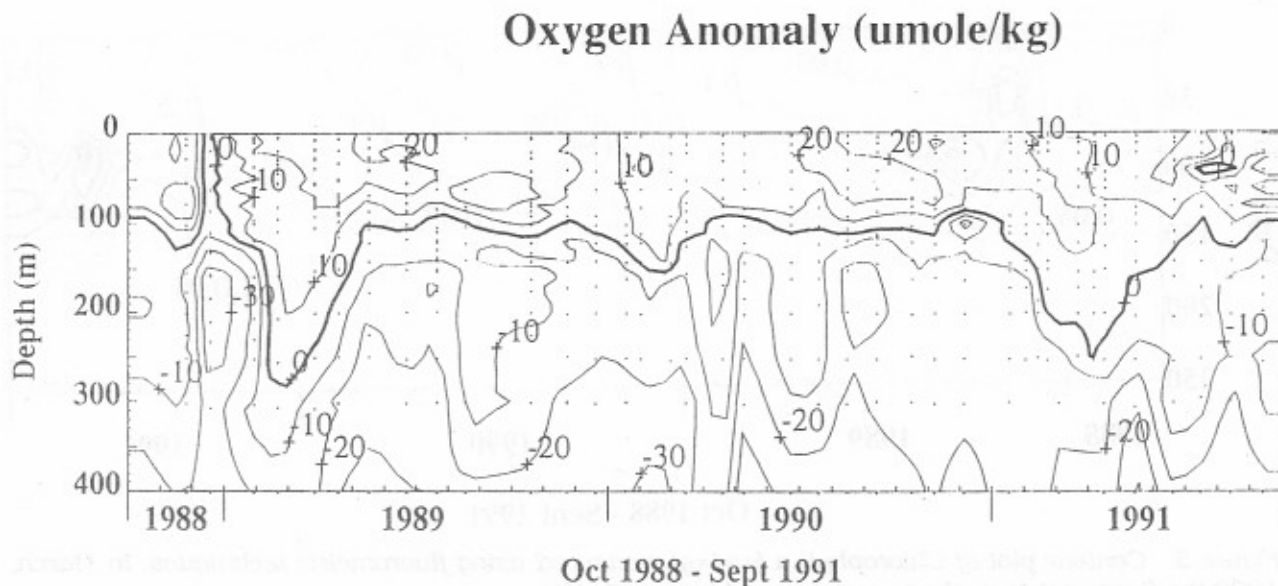

Figure 3. Contour plot of Oxygen Anomaly ( $\mu\text{moles/kg}$ ) at the BATS site. Oxygen anomaly is defined as the difference between the measured oxygen concentration and the calculated saturation concentration of oxygen at the in situ temperature and salinity.

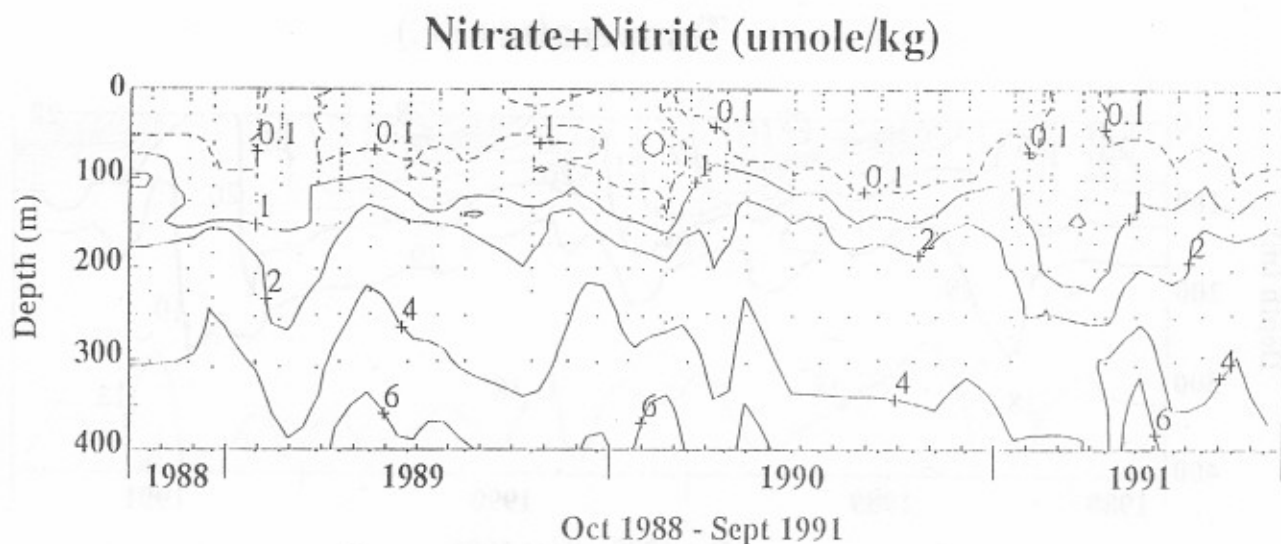

Figure 4. Contour plot of Nitrate+Nitrite ( $\mu\text{mols/kg}$ ) at the BATS site.

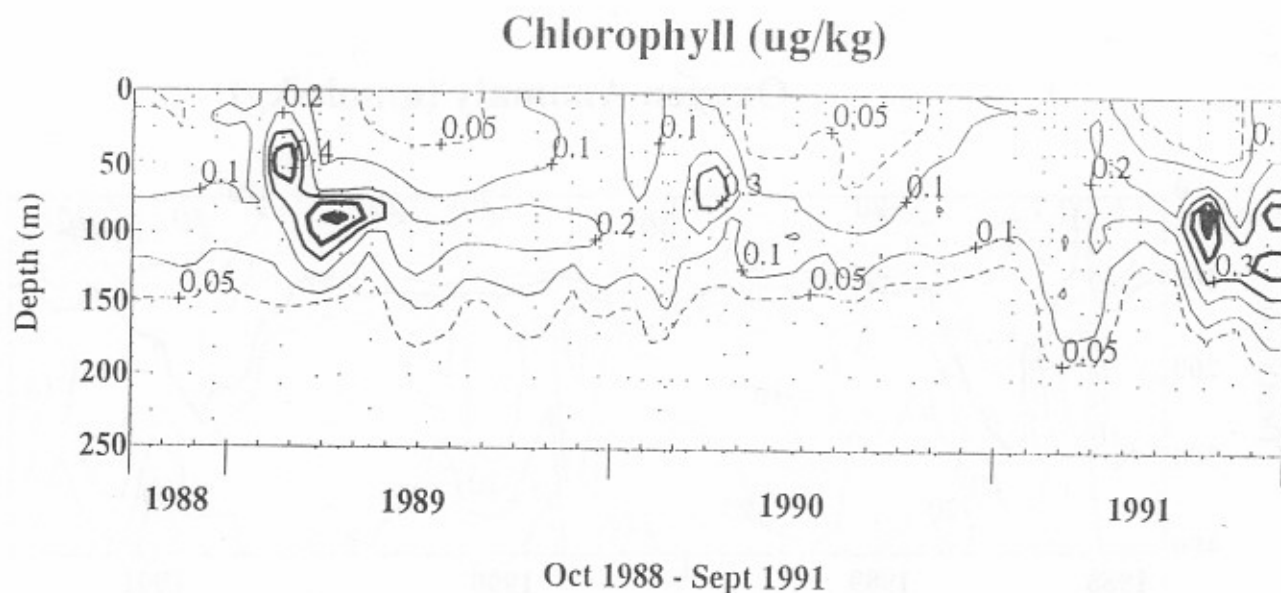

Figure 5. Contour plot of Chlorophyll a ( $\mu\text{g/kg}$ ) measured using fluorometric techniques. In March, 1990 the fluorometric method was changed (see methods).

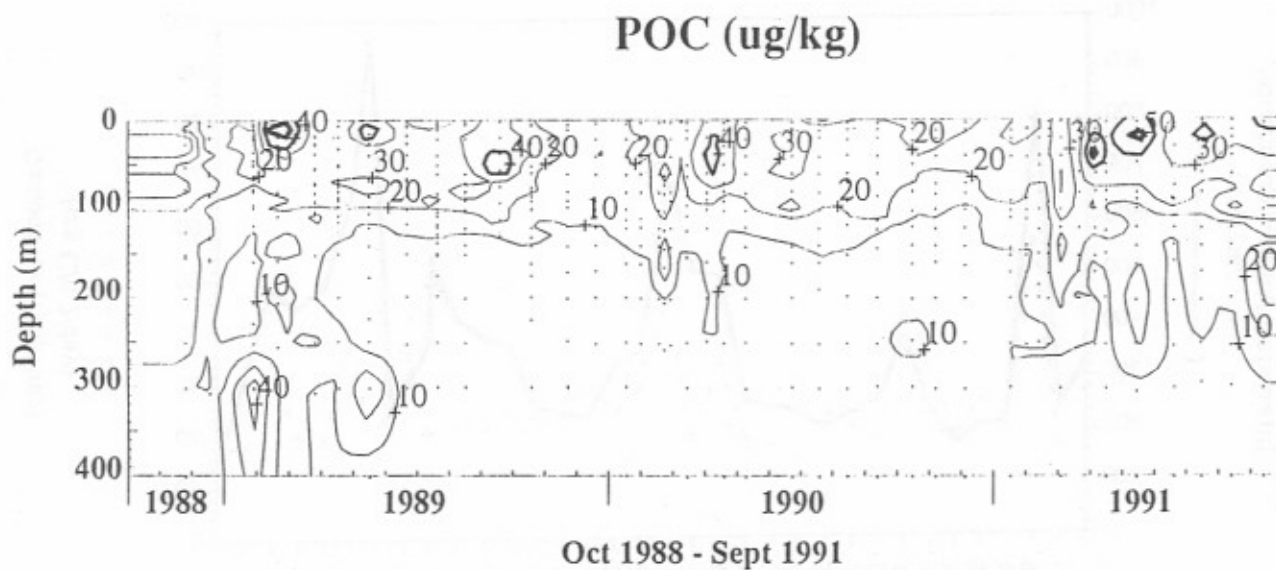

Figure 6. Contour plot of Particulate Organic Carbon ( $\mu\text{g}/\text{kg}$ ) at the BATS site.

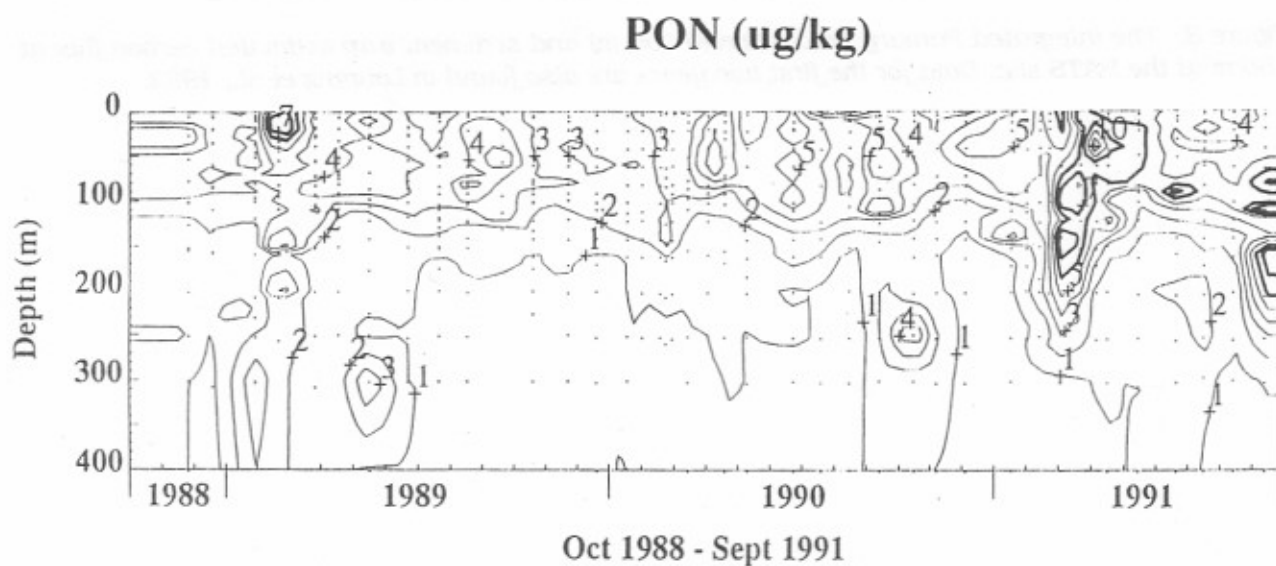

Figure 7. Contour plot of Particulate Organic Nitrogen ( $\mu\text{g}/\text{kg}$ ) at the BATS site.

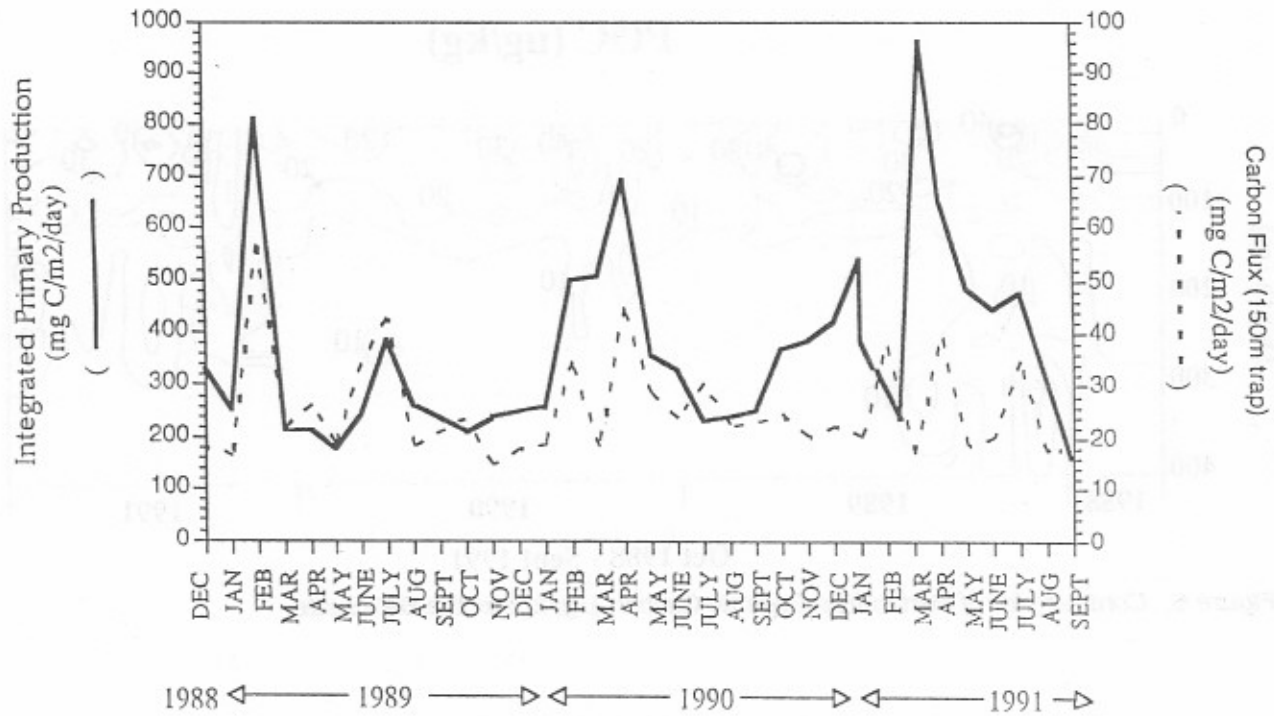

Figure 8. The integrated Primary Production (0-150 m) and sediment trap estimated carbon flux at 150 m at the BATS site. Data for the first two years are also found in Lohrenz et al., 1992.

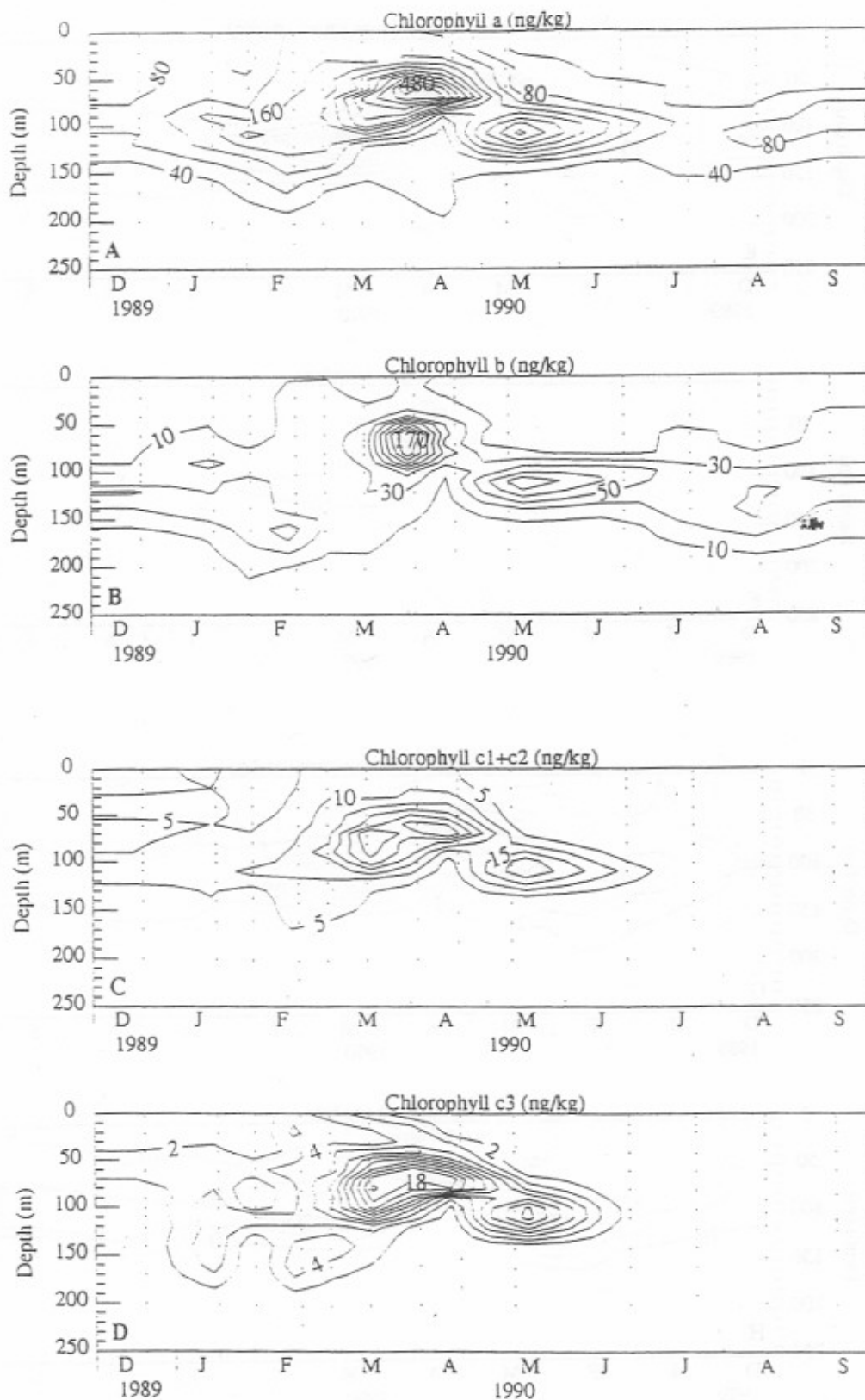
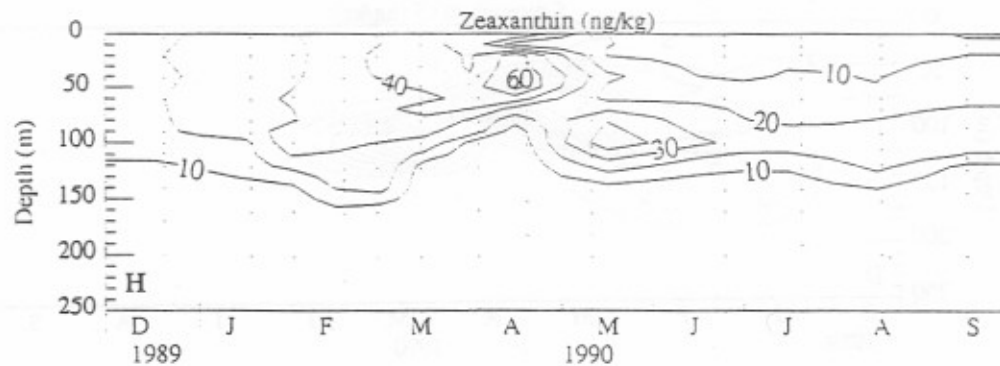
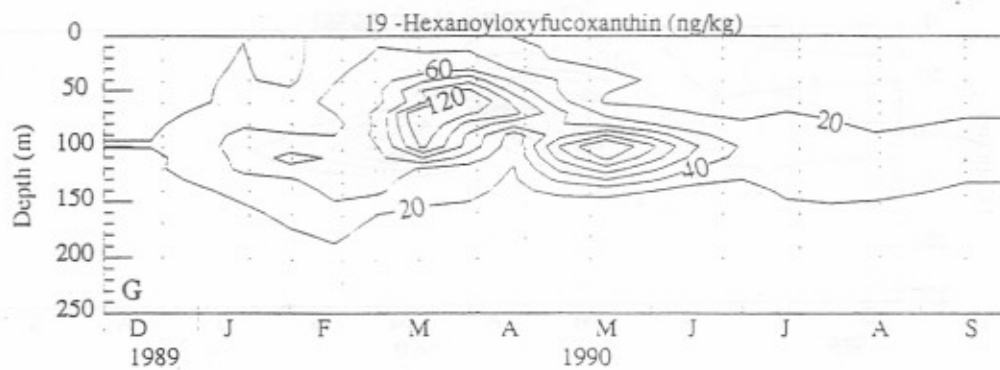
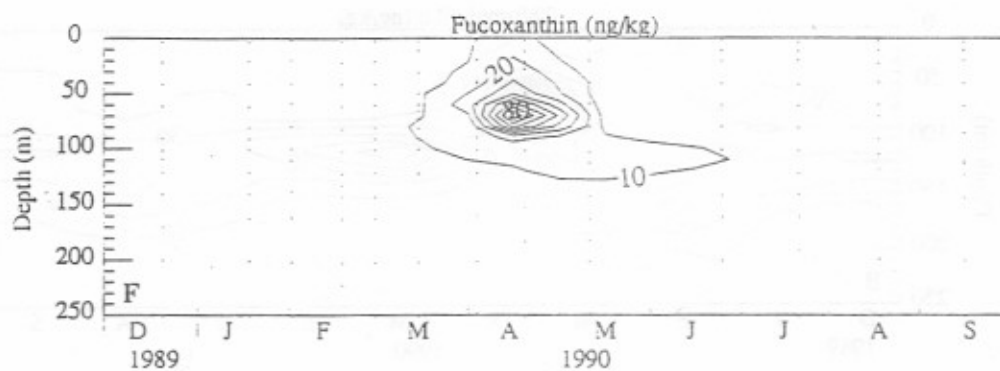
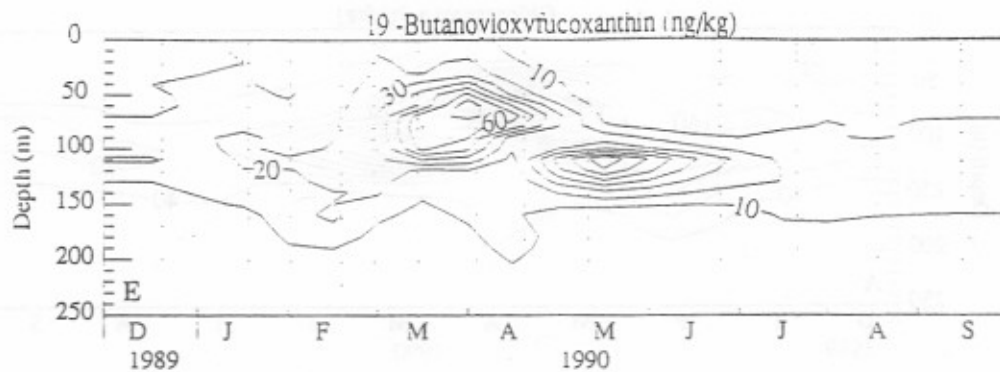
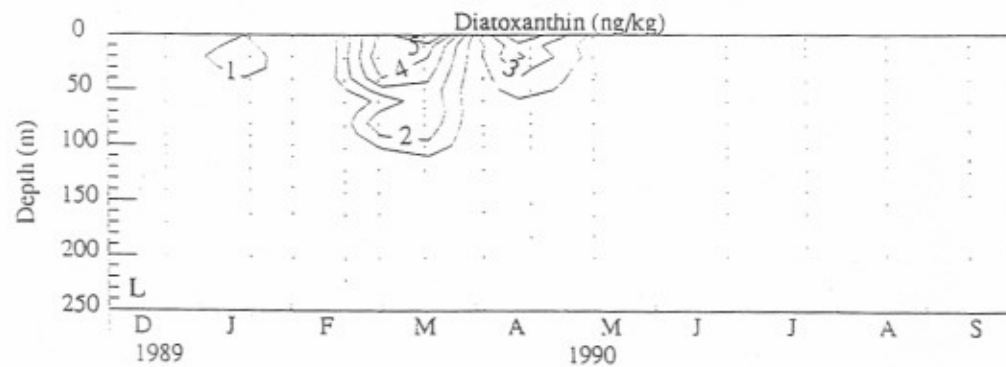
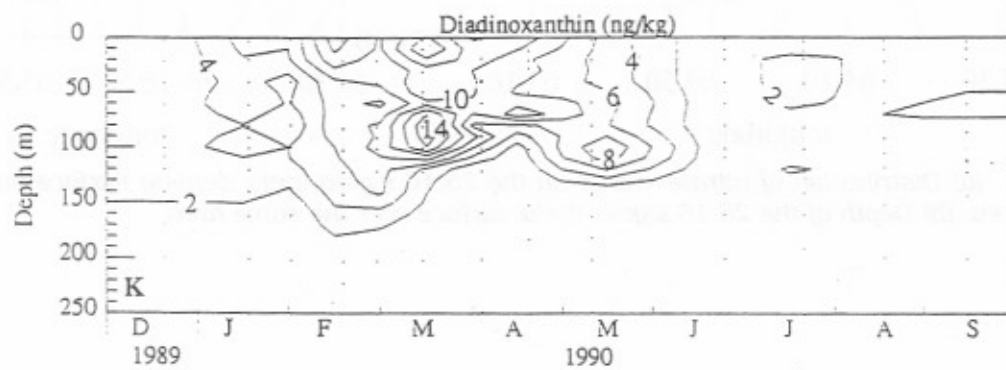
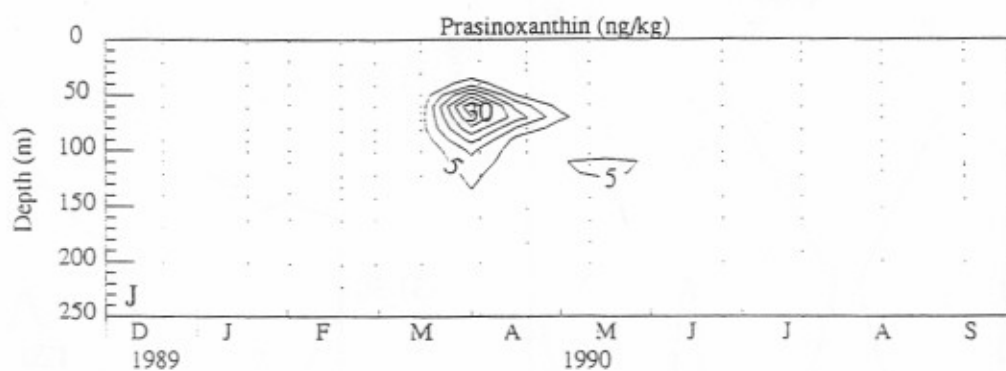
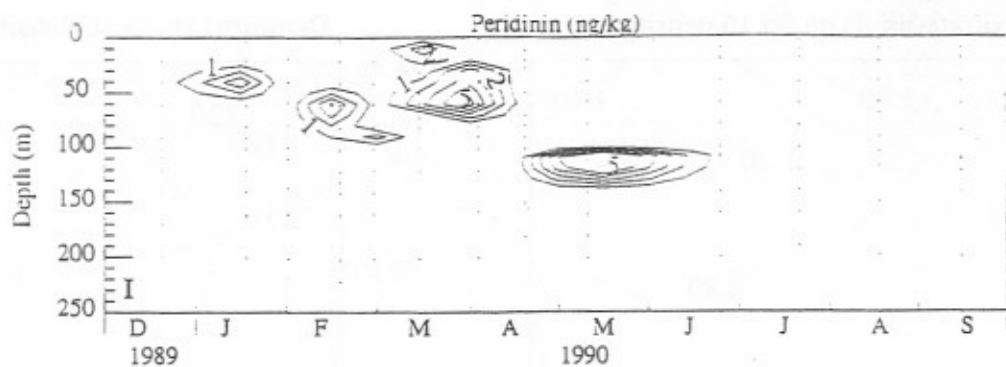

Figure 9. Contour plot of HPLC-determined pigment concentrations (ng L<sup>-1</sup>) at the BATS site during December 1989 - June 1990: (a) chlorophyll a; (b) chlorophyll b; (c) chlorophyll c1+c2; (d) chlorophyll c3; (e) 19'-butanoyloxyfucoxanthin; (f) fucoxanthin; (g) 19'-hexanoyloxyfucoxanthin; (h) zeaxanthin; (i) peridinin; (j) prasinoxanthin; (k) diadinoxanthin; (l) diatoxanthin.







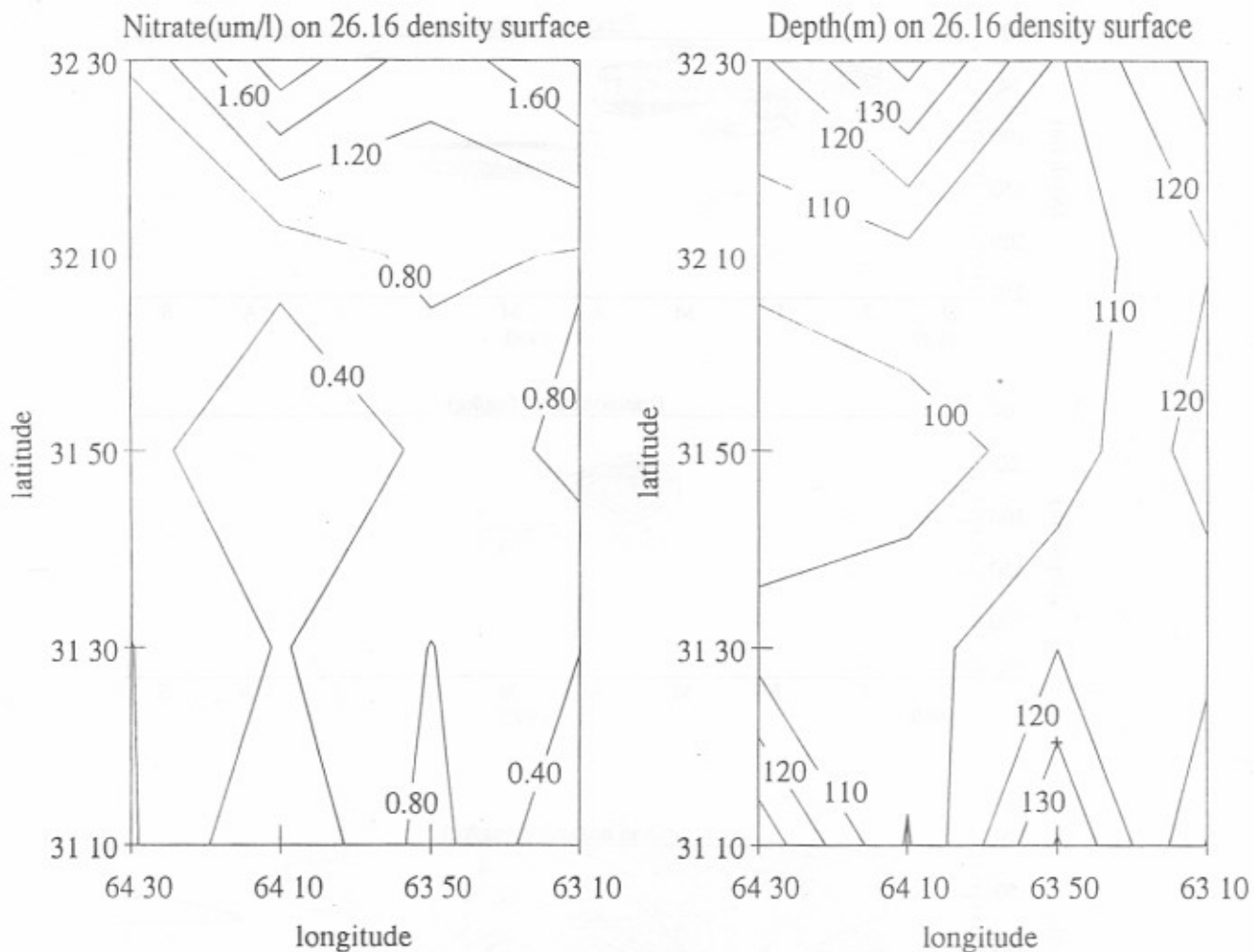
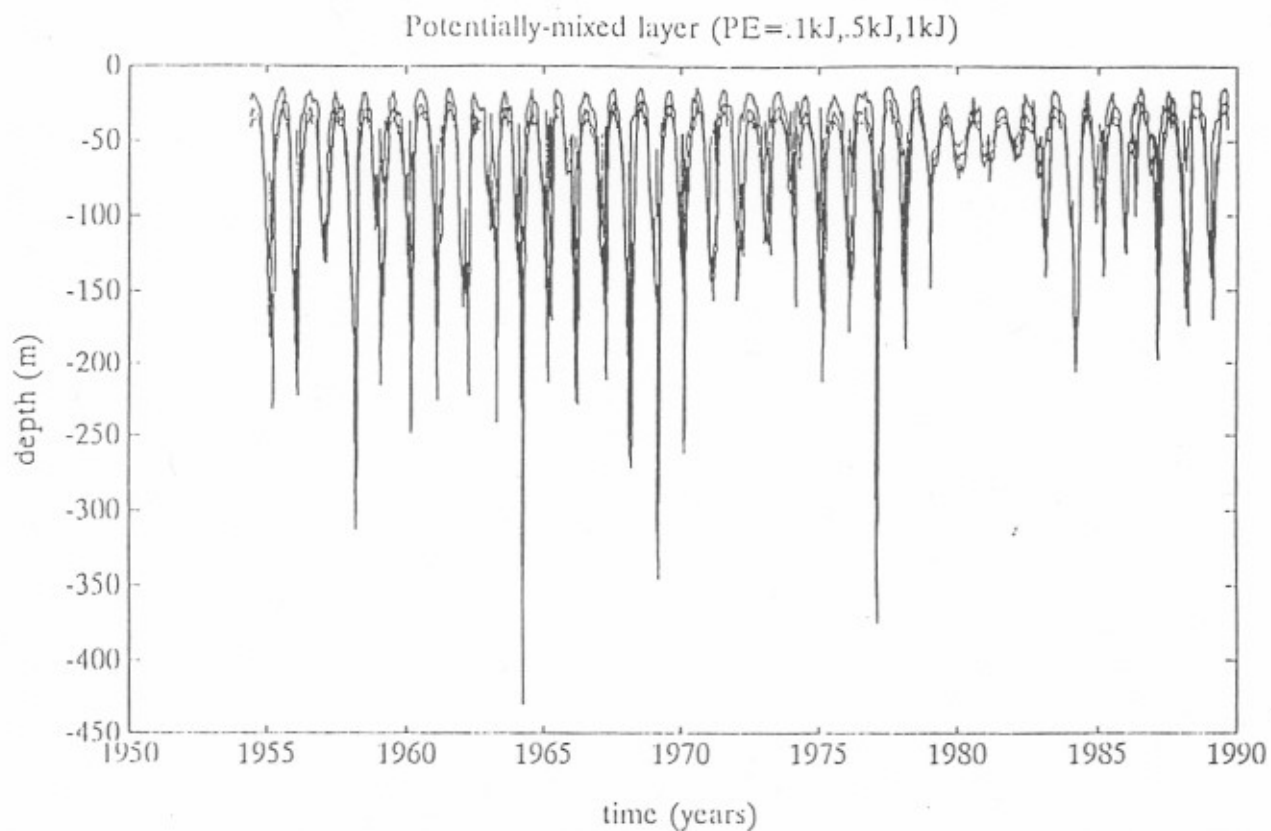

Figure 10. (a) Distribution of nitrate+nitrite on the 26.16 sigma-theta density surface over a 100 x 140 km area. (b) Depth of the 26.16 sigma-theta surface over the same area.



**Figure 11.** Depth of the mixed layer at Hydrostation S between 1954 and 1989. Mixed layer depth is calculated by integration of the potential energy of the density profile from the surface to values of 100, 500 and 1000 Joules.

## **Automated In Situ Observations of Upper Ocean Biogeochemistry, Bio-Optics, and Physics and Their Potential Use for Global Studies**

---

*Tommy D. Dickey, Timothy C. Granata,  
and Isabelle Taupier-Letage*

### **Abstract**

The processes controlling the flux of carbon in the upper ocean have dynamic ranges in space and time of at least nine orders of magnitude. These processes depend on a broad suite of inter-related biogeochemical, bio-optical, and physical variables. These variables should be sampled on scales matching the relevant phenomena. Traditional ship-based sampling, while critical for detailed and more comprehensive observations, can span only limited portions of these ranges because of logistical and financial constraints. Further, remote observations from satellite platforms enable broad horizontal coverage which is restricted to the upper few meters of the ocean. For these main reasons, automated subsurface measurement systems are important for the fulfillment of research goals related to the regional and global estimation and modeling of time varying biogeochemical fluxes. Within the past few years, new sensors and systems capable of autonomously measuring several of the critical variables have been developed. The platforms for deploying these systems now include moorings and drifters and it is likely that autonomous underwater vehicles (AUV's) will become available for use in the future. Each of these platforms satisfies particular sampling needs and can be used to complement both shipboard and satellite observations.

In the present review, 1) sampling considerations will be summarized, 2) examples of data obtained from some of the existing automated in situ sampling systems will be highlighted, 3) future sensors and systems will be discussed, 4) data management issues for present and future automated systems will be considered, and 5) the status of near real-time data telemetry will be outlined. Finally, we wish to make it clear at the outset that the perspectives presented here are those of the authors and are not intended to represent those of the United States JGOFS program, the International JGOFS program, NOAA's C&GC program, or other global ocean programs.

### **Sampling Considerations**

Development of in situ autonomous instrumentation has been driven in part by the need to increase the time and space domains of bio-optical and biogeochemical sampling. Many interdisciplinary studies require homologous data sets for a multiplicity of variables as well. In the past, sampling of hydrodynamical and biological (and biogeochemical) variables was generally achieved independently

(e.g., long term moorings of current meters, short term ship-based surveys with CTD casts and plankton net tows), although a few exceptions are noteworthy (e.g., from ships: Cullen et al., 1983; Smith et al., 1984; from the research platform R/P FLIP: Dickey et al., 1986). Because of the inconsistencies of temporal and spatial resolution and lack of concurrence among data sets, no common data processing technique could be strictly applied. As a result, any cross-interpretation of the non-coherent data sets was hampered, and it was difficult to get valuable information on the bio- and geo-dynamical relationships. In most cases, investigations were limited to qualitative aspects. Now, with multi-variable in situ autonomous systems, it is possible to obtain long term and high temporal resolution data sets, and to perform spectral, correlational, and coherence types of analyses of interdisciplinary data sets. However, no single automated in situ sampling device is sufficient. Ship and spaceborne measurements will still be necessary: 1) to check for the sensor drifts and calibrations, 2) to obtain high precision data, since autonomy usually implies a trade-off between sampling rate and measurement precision, 3) to obtain a comprehensive set of observations, including some variables which are still inaccessible to autonomous methods, and 4) to provide the temporal evolution of the spatial fields using a combination of in situ and satellite image time series.

The Joint Global Ocean Flux Study (JGOFS) program (sponsored by the National Science Foundation, NSF) addresses problems concerning the regional and global estimations of biogeochemical fluxes of materials, particularly carbon, across the air-sea interface, within the interior of the ocean, and at the seafloor (Brewer et al., 1986). Major study-types include: site specific long-term time series studies, regional process-oriented studies, and large scale (global) surveys (U.S. JGOFS Report 11, 1990). Modeling (U.S. GOFs Report 4, 1986; U.S. JGOFS Report 14, 1992) and data management (U.S. GOFs Report 8, 1988) are integral parts of the JGOFS program as well. Complementary studies including the National Oceanic and Atmospheric Administration's (NOAA's) Climate and Global Change (C&GC) program are also being conducted at this time (e.g., Sarachik and Gammon, 1989).

Automated in situ instrumentation is needed for various aspects of JGOFS and C&GC. The availability of automated systems is quite new to the bio-optical and biogeochemical community and the use of such systems for JGOFS and C&GC is in the initial phase at present (Dickey, 1991). One of the objectives of the JGOFS time series program is to determine long-term changes in key and relatively easily measured variables. For physical climate change, temperature is obviously a crucial variable. In terms of biogeochemical and bio-optical changes, variables such as pCO<sub>2</sub>, pH, dissolved oxygen, water clarity, pigment biomass, and phytoplankton productivity are some of the critical quantities. The unambiguous interpretation of measurements used to determine these quantities remains a challenge, however, considerable progress in making high-resolution, long-term bio-optical and biogeochemical measurements has been made and rapid advancements in sensor and system development seem likely. Thus, automated sampling is not only important, but technologically feasible (e.g., Dickey, 1991; Autono-

mous Bio-optical Ocean Observing Systems [ABOOS] Scientific Symposium, 1992). Global scale changes cannot be determined solely from a limited number of time series sites. However, changes at specific sites can be used to monitor long-term trends in oceanic biogeochemical and bio-optical variables, just as the famous measurements at Mauna Loa have provided compelling evidence of atmospheric CO<sub>2</sub> concentration increases (Keeling and Whorf, 1990). Further, these sites can provide excellent opportunities for developing automated sampling systems which can be used at remote time series stations, as part of other JGOFS process-oriented studies, and potentially for long transect/large scale studies.

In terms of links to global observations, automated in situ systems are imperative. Remote sensing of ocean color and the derivation of upper ocean pigment biomass and primary productivity on regional and global scales will be done with the Sea Wide Field Sensor (SeaWiFS) color scanner from a satellite during the next few years (e.g., Yoder et al., 1988; Esaias et al., 1992; Hooker and Esaias, 1992). However, the requisite algorithms rely on in situ observations of bio-optical variables (e.g., Evans, 1992; Hooker and Esaias, 1992; Mueller and Austin, 1992). These observations need to be done in such a way that inconsistencies between satellite and in situ sensors and in temporal and spatial sampling scales can be interpreted and corrected. Additionally, satellite-based ocean color and temperature measurements are often obviated because of cloud or water vapor conditions. Further, the understanding and interpretation of fundamental measurements such as fluorescence remain problematic. Intensive and extensive shipboard sampling at mooring sites and over the world ocean will be important.

Within the next few years, it is possible that moorings may be used for both process-oriented regional studies (presently part of JGOFS and C&GC Equatorial Pacific study) and dedicated time series sites near Bermuda and Hawaii. In the more distant future, it is anticipated that additional time series sites may utilize automated systems deployed from moorings and autonomous underwater vehicles (AUV's). It is possible that drifters and AUV's may be used for improved global coverage as well as for process-oriented and survey studies (e.g., McLean et al., 1992; Olson, 1992; Hitchcock and Olson, 1992).

The development of AUV's is still underway, however their long-term potential for use in JGOFS and C&GC work seems great and their inclusion here seems well-justified. Moored and drifter measurements are presently more advanced and widespread at this point, thus greater emphasis will be placed on them. Time series observations of biogeochemical, bio-optical, and physical variables at present and future JGOFS time series sites and in regions of process-oriented studies are important for several reasons. Some of these are detailed below.

The processes controlling the flux of carbon in the upper ocean have dynamic ranges in space and time of at least nine orders of magnitude (Fig. 1; Dickey, 1991). These processes depend on oceanic biogeochemical, bio-optical, physical, and meteorological variables. These variables should be sampled on scales matching the relevant processes (e.g., aliasing problem: Nyquist sampling theory). Ship-

based sampling, while critical for detailed and more comprehensive observations, can span only a limited portion of these ranges because of logistical and financial constraints (Figs. 1 and 2). For example, data collected from present JGOFS time series sites near Bermuda (Knap et al., 1990; Michaels and Knap, 1992; Michaels et al., 1992) and Hawaii (Karl and Winn, 1991) as well as programs elsewhere (e.g., coastal waters off Long Island, New York: Whitley and Wirick, 1983, 1986, Medeiros and Wirick, 1992; off Los Angeles: Dickey and Manov, 1991 and work in progress; in Monterey Bay, Chavez et al., 1992); Sargasso Sea and near Iceland: Dickey et al., 1991; 1992a,b; Dickey, 1991; Marra et al., 1992) indicate that variability in key derived quantities such as pigment biomass and primary productivity often occurs on time scales of days or less. This variability results from local, advective, or various mixes of local and advective phenomena. It is important to note that the problems being addressed are nonlinear in nature and episodic forcing and responses probably contribute large proportions of the variance (e.g., Dickey et al., 1991; Dickey et al., 1992a,b). Thus, it is important that high-resolution time series data (including currents) be collected concurrently at the sites and that horizontal/vertical spatial data be collected in the vicinity of the sites. Fortunately, it is now possible to do measurements of several of the principle variables from moorings on time scales as short as 1 minute (e.g., Dickey, 1991).

Remote sensing of the very near surface ocean can provide important sea surface temperature, ocean color, and sea surface elevation data on scales as small as a few kilometers to tens of kilometers with repeat orbits on order of a day (e.g., Dickey, 1991). However, the sampling of the subsurface ocean on horizontal scales of hundreds of meters is presently limited to ship-based operations (e.g., tow-yo's). Extended sampling of longer than a few weeks is generally prohibitive because of shiptime costs (biweekly to monthly at best). For this reason, development and utilization of various platforms including autonomous underwater vehicles (AUV's) is highly desirable (Figs. 2, 3, and 4).

It has been suggested that only a limited number of comprehensive island or coastally based time series sites can be accommodated by the JGOFS program. Nonetheless, some of the most important locations reside in remotely located and environmentally hostile regions. In order to sample at such sites, it will be imperative to utilize automated sampling platforms including moorings, drifters, and AUV's.

One of the advantages of automated sampling is that data collected from such systems, in principle, can be transmitted in near real-time to shore-based laboratories around the world. The Argos satellite communication system (developed in the mid-1970's, instruments flown on NOAA weather satellites) is presently used by programs such as the Tropical Ocean Global Atmosphere (TOGA) program to distribute meteorological and physical data in near real-time (e.g., McPhaden, 1988). The near real-time capability is useful for continuous monitoring, planning sampling strategy, and for insuring data retrieval in the event of instrumentation loss or major malfunction in data recording. Near real-time communications

systems will be discussed in more detail later. The next sections will discuss the present status of and some potential future directions for automated systems

### **Examples of In Situ Automated Systems and Collected Data**

Development of autonomous sensors and systems requires special consideration of constraints such as sampling rate, power consumption, data storage, and biofouling. These constraints are common to both moored (fixed depth or profiling systems) and drifting modes; thus, the same sensors can usually be used for either application without major modification. Some of the variables which can now be measured autonomously in situ include: temperature, conductivity, currents, stimulated and natural (683 nm upwelling radiance) fluorescence, photosynthetic available radiation (PAR), beam transmission (660 nm), dissolved oxygen, pH, and downwelling and upwelling radiances (several wavelengths available, some matching SeaWiFS wavelengths). Other variables (shape, size, and concentration of living or detrital particles) are accessible by cameras (e.g., Asper, 1987; Gardner and Walsh, 1990; Walsh, 1990). Data are typically recorded every few minutes to every hour.

Acoustical systems are useful for current measurements and for determining distributions of organisms (e.g., zooplankton) larger in scale than phytoplankton (e.g., Haury and Pieper, 1987; Flagg and Smith, 1989; Plueddemann and Pinkel, 1989; Pieper et al., 1990) and can be used to provide important complementary spatial and time series data sets for ecological studies. Some variables cannot be determined in situ by analog devices, but coarse time series can still be obtained using samplers, such as sediment traps and water bottle samplers. Several successful experiments have now been done using moored and drifting bio-optical, physical, and geochemical sensors in the open and coastal ocean (e.g., Dickey, 1991).

### **Moorings**

Collection of moored bio-optical data began in coastal waters in the late seventies (e.g., Whitley and Wirick, 1983, 1986), but the use of moorings for this purpose in the open ocean has only recently begun (e.g., Dickey, 1991; note insert in Fig. 5). Nonetheless, data have been collected from moorings in several regions of the world ocean (see world map of Fig. 5 and summary in Table 1). Some of the moored sensors include: thermistors, conductivity sensors, vector measuring current meters, strobe fluorometers, natural fluorometers (683 nm upwelling radiance), photosynthetic available radiation (PAR) sensors, beam transmissometers (660nm), dissolved oxygen sensors, spectral downwelling irradiance sensors (410, 441, 488, 520 and 560 nm), and spectral upwelling radiance sensors for the same wavelengths (e.g., for Biowatt experiment in Sargasso Sea: Dickey et al., 1991; Smith et al., 1991; Dickey et al., 1992a; Marra et al., 1992). Data are typically recorded every few minutes to every hour. It is possible to do spectral analysis of bio-optical and biogeochemical data as well as physical data. The

processes contributing to variability shown in resulting spectra include diel cycles of phytoplankton, tides, inertial currents generated by passing weather systems and wind events, and internal gravity waves. For illustration, time series obtained from a multi-variable moored system (MVMS; see inset of Fig. 8) located at 10m depth south of Iceland (59N 21W) are shown in Fig. 6 (Dickey, 1991; Stramska and Dickey, 1992b; Dickey et al., 1992b). The work was done as part of the Office of Naval Research (ONR) sponsored Marine Light in the Mixed Layer (MLML) experiment (1989 and 1991), and the site was at the northern extreme of the JGOFS North Atlantic Bloom Experiment (NABE) conducted in the spring of 1989. During 1991, MVMS data were collected each minute for about two months (total of eight depths in the upper 250 m) and illustrate high variability in physical and bio-optical parameters. Advection associated with mesoscale current features and semi-diurnal tides are observed. Diurnal signals are seen at 10m in PAR, beam attenuation coefficient, stimulated fluorescence and derived primary production (not shown, see Dickey, 1991) based on upwelled radiance at 683 nm (Kiefer et al., 1989). The phases of these signals suggest that photoinhibition of the phytoplankton may be occurring (indicated by depressed fluorescence during mid-day; Stramska and Dickey, 1992b). Short time scale fluctuations associated with clouds are also apparent in the PAR time series. A major spring bloom event is evident after JD 140 when stratification begins abruptly. The 1991 MLML experiment was done at the Iceland site and included MVMS's as well as other moored optical (bio-optical moored systems [BOMS], Smith et al., 1991) and bioluminescence sensors (Case, personal communication), a moored Acoustic Doppler Current Profiler (ADCP; Plueddemann and Weller, personal communication), and temperature sensors.

Mooring data sets can presently be used to obtain high resolution time series of the following derived or modeled quantities: current shears, stratification, mixed layer depth, mixing time scales, particle concentrations, pigment biomass, depth integrated pigment biomass, primary production, "new" production (Dugdale and Goering, 1967), the vertical flux of particulate carbon, depth integrated primary production, oxygen respiration and utilization, and the flux of dissolved oxygen across the air-sea interface. Application of models to mooring data strongly suggests that short-lived episodic bloom events must be sampled for proper determinations of upper ocean carbon flux (e.g., Dickey, 1991; U.S. JGOFS Planning Report 14, 1992). It is likely that the magnitude and timing of seasonal and interannual variations may be impacted by a few intense events. Any detailed modeling of biogeochemical fluxes will require information on short as well as longer time scales.

There have also been coarse time series measurements using sediment traps (e.g., Honjo et al., 1990) and water bottle samplers (e.g., Abbott et al., 1990). In addition, ocean bottom sampling tripods (e.g., Berelson and Hammond, 1986) have been used for time series measurements.



## Drifters

The motivation for the use of drifters is to track water parcels to determine Lagrangian currents and to ascertain associated variability in bio-optical and biogeochemical parameters. Drogues are sometimes designed to track currents at a specific depth. Ideally, there is no slippage between the drifter or drogue and the water, so that in principle a given water parcel is followed (e.g., Niiler et al., 1988). This is a desirable situation for biogeochemical and bio-optical studies which are concerned with changes occurring within a specific water mass. Bio-optical and biogeochemical measurements from drifters have been attempted by only a few investigators (e.g., see Wilkerson and Dugdale, 1987). As one example, the Arctic Environmental Drifting Buoy (AEDB) was designed to obtain multi-disciplinary data in remote regions of the Arctic (Honjo et al., 1990). The buoy was equipped with thermistors, conductivity sensors, an ADCP, an electromagnetic current meter, two strobe fluorometers, a beam transmissometer, and a sequential sediment trap. The data obtained from these instruments and the position of the buoy were logged internally and transmitted via satellite using Argos transmitters during a drift of 3900 km in 255 days (Honjo et al., 1990, Fig. 5).

As part of the Coastal Transition Zone (CTZ) Experiment, Abbott et al. (1990) deployed a Lagrangian drifter (TriStar-II) with a tethered instrument package consisting of a spectroradiometer, a strobe fluorometer, a thermistor, and a beam transmissometer. In addition, an automated water sampler was located below the drogue at 17.5m and water was collected at 6h intervals for phytoplankton and nutrient analysis. Finally, a thermistor chain was placed beneath the water sampler for temperature measurements at depth. The drifter appeared to have followed a cold filament directed generally offshore. The drifter record is 8 days long and several interesting physical and bio-optical observations resulted. For example, the time series of temperature (Fig. 7) indicates that the water tracked by the drifter generally warmed (probably due to a combination of surface heating and advection), had a modest diurnal heating cycle, and occasionally changed in temperature abruptly (seen as steps) apparently because of encounters with frontal or water interleaving regions. The time series of downwelling light at 520 nm (Fig. 7) shows an expected diurnal cycle, with some modulation by clouds (also observed elsewhere by Dickey et al., 1991; Stramska and Dickey, 1992a; 1992b). Both the beam attenuation coefficient and stimulated fluorescence time series show diel rhythms and generally decrease in time (Fig. 7). It is likely that the beam attenuation diel rhythm is related to daytime particle (phytoplankton) production and nighttime grazing by zooplankton (e.g., Siegel et al., 1989; Hamilton et al., 1990; Gardner et al., 1990; Cullen et al., 1991; Stramska and Dickey, 1992b), however effects of variations in cell refractive index and size may be important as well (e.g., Ackleson et al., 1990). The diel rhythm in fluorescence is probably related to these same effects, but is modified by physiological modification of the phytoplankton which may either photoadapt to optimize growth, be photoinhibited resulting in a lower productivity, or have intrinsic diel rhythms (Kiefer, 1973). Other investigators are also planning large scale drifter studies utilizing bio-

optical sensors (Abbott, 1992; McLean et al., 1992; Abbott, Lewis, Hitchcock, and Olson, personal communications).

Another approach is to utilize an autonomous profiler equipped with bio-optical and physical sensors. The profiler, which ascends and descends by programmed buoyancy changes, can be either moored (e.g., Dickey and Van Leer, 1984) or used in drifter mode (Dickey, 1988; Marra et al., 1990; also under ice: Van Leer and Villanueva, 1986). The profiler (e.g., multi-variable profiler, MVP; see Dickey, 1988) can carry current meters, temperature and conductivity sensors, a transmissometer, a fluorometer, and a PAR sensor. Data have been transmitted via radio back to shore and ships for real-time data acquisition. This method frees ships for other concurrent sampling.

The isopycnal float (density following) fluorometer (IFF) developed by Hitchcock et al. (1989) includes a fluorometer, a pressure transducer, and a thermistor to measure subsurface water parcel motions (e.g., including upwelling and downwelling velocities) and simultaneous changes in chlorophyll a fluorescence in three dimensions. Temperature and pressure data are stored every 15 min and fluorescence data are stored every 30 m. Data collected over 4 hour intervals are transmitted via an acoustic link.

One of the principal attractions of drifters and floats, which are equipped with physical and bio-optical sensors, is that broad geographical regions can be sampled (representiveness is complicated by flow convergences etc.). On the other hand, the statistical interpretation of such data is quite complicated, since the measured variability results from variations in both space and time. Further, drifters' actual trajectories cannot be strictly interpreted as following water parcels' trajectories. In the future, some drifters will be designed to be recovered (some losses will be inevitable) while others will be considered expendable. Thus, for this approach to be viable for general usage, satellite telemetry of data and production of large numbers of sensors of moderate cost will be required.

## **Future Sensors and Systems**

### **Sensors**

Although much progress has been made in our capability to sample the marine ecosystem, its biogeochemistry, and its bio-optics, there remain several obvious high temporal resolution measurements which need to be included in future systems. For example, the further advancement of bio-optical measurements will require a variety of sensors which measure a more comprehensive set of optical variables so that inherent (those independent of a natural light source) and apparent (those dependent on a natural light source) optical properties may be related. Devices which are needed to better characterize the inherent optical properties are spectral absorption and scattering meters (e.g., Carder et al., 1988; Zaneveld and Bricaud, personal communication). The pump and probe fluorom-

eter of Falkowski et al. (1991) shows promise for primary productivity measurements. Applications of present instruments can be extended as well. For example, by modifying the emission/reception characteristics of a strobe fluorometer, it is possible to do measurements of fluorescence of specific pigments. This has been done by Iturriaga et al. (1990) for cyanobacteria. Finally, the use of fiber optics to bring light signals from depth to the surface for signal processing and data analysis appears to be a viable option for several physical and bio-optical applications (e.g., Cowles et al., 1990). Efforts are also underway to develop expendable instrumentation using fiber optics (e.g., Weidemann and Hollman, 1992). The measurement of apparent optical properties such as downwelling irradiance and upwelling radiance using spectral radiometers has progressed during the past decade. It will be most important for new in situ radiometers to be able to measure with higher spectral resolution (few nanometers) across the visible (and into the ultraviolet region) in order to link in situ data with advanced satellite (and aircraft) observations (multiplicity of wavelengths) and for spectral bio-optical models of primary production and species identification (e.g., Bidigare et al., 1987; Morel, 1991; Bidigare et al., 1992).

The development of fast response in situ autonomous chemical sensors for deployment from CTD and autonomous packages has begun with dissolved oxygen and pH sensors, but comparable sensors for total carbon dioxide and other specific ions (e.g. nutrients) are still under development for moorings and drifters (see ABOOS Symposium abstracts). However, development of chemical analyzers (involving reagents and active transportation of the fluids to detector) is relatively advanced (e.g., Johnson et al., 1992; Jannasch and Johnson, 1992). Acoustical systems are useful for current measurements and for determining distributions of organisms (e.g., zooplankton) larger in scale than phytoplankton (e.g., Haury and Pieper, 1987; Pieper et al., 1990) and can be used to provide important complementary spatial and time series data sets for ecological studies.

### **Autonomous Underwater Vehicles (AUV's)**

Exploration of the subsurface ocean has been done for the most part using submersibles or remotely operated vehicles, and thus required human intervention. These methods are costly and require considerable manpower. Thus, there is renewed interest in the development of autonomous underwater vehicles (AUV's) which could be used for regional and global sampling as well as exploratory operations. AUV's can be thought of as "robotic submarines." A generic AUV may be defined to be a free-swimming, untethered vehicle with its own power supply, propulsion unit, computer intelligence systems for decision making and navigation, communication links and telemetry, system and scientific sensors, and discrete water samplers.

Interestingly, several institutions have been involved in AUV development over the course of the past 30 years (see review by Blidberg, 1991). Development of prototype AUV's is currently underway at several institutions in the U.S. These include: the University of New Hampshire (Experimental Autonomous Vehicle

[EAVE], Blidberg, 1991), Florida Atlantic University (Ocean Voyager, Dunn, 1991), Woods Hole Oceanographic Institution (Autonomous Benthic Explorer [ABE], Yoerger et al., 1991), the Draper Laboratory [DARPA/Navy Test-Bed UUV], Pappas et al., 1991), and the Naval Postgraduate School (NPS AUV, Brutzman and Compton, 1991). Besides efforts in the U.S., a major thrust is being made by the British as they are developing the Autosub (Woods, 1991a,b; McCartney and Collar, 1991) with specific application for climate-related hydrographic work which will continue beyond the World Ocean Circulation Experiment (WOCE) and the British Biogeochemical Ocean Flux Study (BOFS). The French too have been leaders in the development of AUV's (see Blidberg, 1991). The current enthusiasm for AUV's is spurred in part by technological advances in miniaturized computers and artificial intelligence. In addition, a broader suite of oceanographic sensors and water samplers is now available. Several of the necessary electronics, computer control, and scientific sensor capabilities are being utilized for moored and drifter instrumentation used for bio-optical and biogeochemical as well as physical observations as described earlier.

A workshop on AUV's, sponsored by the National Science Foundation, recently brought together ocean engineers presently working on AUV technology and scientists interested in problems which may benefit from utilization of AUV's (see Blidberg and Sedor, 1991). Some of the important conclusions relevant to the JGOFS and C&GC program objectives included:

1. AUV's can benefit the oceanographic community by enabling unique sampling which cannot be accomplished with other existing platforms and by providing cost-effective and expanded oceanic observational capabilities.
2. Technological advances over the past decade have made the utilization of AUV's a potentially feasible option for many physical, bio-optical, and geochemical research efforts.
3. AUV's are envisioned as being capable of providing data on horizontal and vertical scales which complement sampling from satellite, mooring, and ship platforms, but will not replace these sampling modes. They are particularly attractive platforms for 4-dimensional (space plus time) mapping applications (especially where horizontal gradients are intense). Initial studies, which do not require endurance beyond a few days, could include mapping in the vicinity of time series sites (preferably in vicinity of moorings) and coastal outfalls. The JGOFS Hawaii and Bermuda time series sites would be excellent candidates for such preliminary efforts.
4. Some of the special studies which could be done with an AUV include: active object following (e.g., marine snow, plankton, and nekton), plume signature (based on gradients) tracking, finding sources of Antarctic bottom water, and sediment trap monitoring. Also, AUV's could be used on a "stand-by" basis (cued by near real-time mooring and satellite data) for rapid response to explore important phenomena such as the role of major oceanic storms in promoting nutrient flux to the euphotic zone and open ocean blooms of *Trichodesmium*.
5. Major AUV development areas which need to be addressed include reliability (greater than 10,000 hours), endurance (greater than 1,000 km), and longevity

of missions (from present capability of a few days to at least 30 days).

AUV technology needs to be considered in the planning of future regional and global studies such as JGOFS and NOAA's global ocean observing system. Their use at time series sites, in process studies, and for large scale observations could facilitate the accomplishment of many of the goals of JGOFS and C&GC as well as many other programs in the future. AUV development is progressing (see ABOOS Symposium abstracts), but it must be emphasized that utilization for JGOFS and C&GC will depend on support and success of engineering efforts. It will be important to develop cooperative efforts with other countries which are active in the development of AUV's. There appear to be no major technological barriers to successful development. Further, it is likely that most sensors which are being, or will be, used on moored and drifter systems can be used on AUV's. AUV data telemetry will probably rely heavily on acoustical and satellite methods (see Telemetry section).

### Data Management Issues

The collection of interdisciplinary data from automated systems at relatively high sampling rates has become possible only within the past few years (e.g., review by Dickey, 1991). Thus, problems concerning the management of the resulting data, while considerably less severe than those of satellite oceanographers, are of concern for our community. On the other hand, they are similar to, though somewhat more demanding than, those of physical oceanographers as time series of many more variables are being collected.

The following discussion concerns a hypothetical estimate of the future annual volume of data which may be collected using automated sampling systems for programs such as JGOFS or NOAA's global ocean observing system. As such, nominal values of parameters are based on past sampling regimes and no adjustments for specific sensor failures, etc. were made (Tables 1 and 2). Many of the reports are very recent and detailed information remains rather incomplete. These tables are also useful for illustrating the remarkably fast growth rate of this approach to oceanography (also see inset in Fig. 5). The projected data amounts (Table 3) are only hypothetical, but serve to suggest potential data management needs. The amount of data (A, in bytes) obtained from a particular instrument at a given depth and for a specific period is given by

$$A = d \times n \times r \times T$$

where

d = no. of bytes of data/no. of variables/no. of records

n = no. of variables

r = no. of records/unit of time

T = duration of deployment

As an example, data (10 variables) were collected from one MVMS in the Sargasso Sea (Biowatt) in 1989 (Dickey et al., 1991, 1992a) at a sampling rate of once per 4 minutes for approximately 9 months ( $3.89 \times 10^5$  minutes) in 1987. Using the formula above,

$$A = (4 \text{ bytes/var/rec}) * (10 \text{ var}) * (1 \text{ rec}/4 \text{ min}) * (3.89 \times 10^5 \text{ min})$$

$$A = 3.89 \text{ Megabytes (Mbytes) per MVMS}$$

where var is the number of variables and rec is the number of records. For the Biowatt Sargasso Sea experiment, eight MVMS and two to three BOMS were used giving a potential of about 34 Mbytes of data. Again, similar measurements were done south of Iceland (MLML) for about 2 months in 1989 (Dickey et al., 1992b, Stramska and Dickey, 1992b) and for about 4 months in 1991, but with a few more variables and at a sampling rate of once per minute. More recently, we have done MVMS measurements (total of 4) off the coast of California (NOAA's Sea Grant program, Dickey and Manov, 1991) at a rate of once per minute for 2 months, and presently data are being collected in the equatorial Pacific (NSF: JGOFS/NOAA: C&GC program, Dickey, in progress) using 4 MVMS at a rate of once per 3.75 min (for the sake of compatibility with other instruments sampling rate). The volume of MVMS data thus far collected amounts to over 150 Mbytes. These data sets are processed on an advanced VAX II computer. Several steps are required in the processing. These include: conversion from voltages to engineering units (including calibration), error checking, statistical analysis, and graphical products (e.g., time series plots, contour maps, etc.). Various filtering schemes are applied depending on the frequency domains of interest.

Several mooring and drifter studies were used to compile data amounts for work done within the past 15 years, however most of the data have been collected within the past 5 years (inset of Fig. 5). Several studies are summarized in Tables 1 and 2. Again, some very recent studies were described at the ABOOS Symposium in the form of abstracts. As an exercise, we have made the following hypothetical projections. We suppose that on an annual basis, there may be as many as 1) 30 moorings collecting data (~24 variables) at 4 depths at a rate of once per minute at various sites of the world ocean, 2) 200 drifters collecting data (~22 variables) at 2 depths at a rate of once per minute [roughly equivalent to 8000 drifters sampling 10 variables at 1 depth: an alternative approach], and 3) 10 AUV's collecting data (~22 variables) at a rate of once per minute. Using this information and the above equation, we estimate that the annual volume of data collected from automated in situ systems would be approximately 6.2 Gbytes per year.

Many available work stations are suitable for most of the required computational activities. Software packages such as the Interactive Display Language (IDL) provide large libraries of subroutines that run on UNIX operating systems. The software also supports window and graphic environments. Workstations can also be used to produce color maps, 3-D images, and vertical profiles of interdiscipli-

nary data. The volume and complexity of these multi-variable data sets require new and innovative methods of data reduction, display, and integration with complementary data (e.g., meteorological and historical data). In terms of long-term data management, raw and processed data sets need to be backed up on storage media such as tapes or preferably optical disks. Access to data can be provided through a variety of computer networks.

### **Near Real-time Telemetry**

One of the implicit goals of global programs such as JGOFS and C&GC is the development of observing systems which, in large numbers, would collectively facilitate the long-term collection of interdisciplinary oceanographic data in near real-time in analogy to international atmospheric programs such as the World Weather Watch (e.g., Baker, 1991). These future data will serve several purposes. They will be used to give descriptions of the state of the oceans, for development of parameterizations for models, and to provide initial conditions for short-term as well as climatic-scale forecasts. For many satellite applications, near real-time telemetry is already a natural part of the process and will continue to be (e.g., Evans, 1992). However, the telemetry of in situ data is still a developing area, though the basic technology is available (e.g., Frye et al., 1991; Brooks and Briscoe, 1991; Walker, 1991). It should be noted that the telemetry of in situ data from platforms such as moorings, drifters, and AUV's is further motivated by the need for experimental design and sampling strategy, for diagnosis of instrumentation problems, for modifying sampling rates, and importantly by the need to insure against the loss of data because of damage to or loss of the platforms.

True real-time (no delay) data transmission of interdisciplinary data from sampling platforms has generally been confined to nearshore deployments thus far. Booth et al. (1987) used a direct electrical conducting cable connection to transmit data collected near Scripps Institution of Oceanography. Radio telemetry of data collected from near surface instruments has been used off the coasts of Long Island (Whitledge and Wirick, 1983), Peru (Dickey and Van Leer, 1984), Monterey, California (Chavez et al., 1991, 1992), and Los Angeles (work recently completed by Dickey et al. and Walker and Douglass, 1992). The experimental mooring and the telemetry system used for the Los Angeles study are illustrated in Fig. 8 with resulting near real-time data collected from the 10m MVMS being shown in Fig. 9. Both telemetered (crosses) and stored (dots) data are shown for two days of a 40-day time series. For open ocean problems, this methodology is too geographically restrictive.

An interesting approach to the data telemetry problem has been described by Brooks and Briscoe (1991). They reported on tests of high-frequency ionospheric radio propagation systems which do not involve satellites. This methodology has become more practical with advances in antennas, receivers, and digital data processing. These systems are relatively economical in cost and capable of passing data at moderate rates (~1-10 bits/sec) averaged over several days. Higher data

rates (possibly up to ~100 bits/sec) may be possible under optimal conditions. One disadvantage is that it may be necessary to store data for days to weeks prior to transfer because of the need to have adequate propagation path characteristics, thus impairing the more truly near real-time capability. However, the technology is readily available and two-way exchanges are possible. The coverage is essentially global, but intermittent and dependent on sunspot activity, interference, and skip zones. The ocean hardware necessary for this approach will be more suitable for reusable ocean buoys rather than small expendables.

The two primary types of satellite telemetry systems for obtaining near real-time (delay of few hours to one-half day in general) are polar-orbiting systems such as the NOAA TIROS satellites with Argos data collection systems and the geosynchronous satellite systems such as the Geostationary Operational Environmental Satellites (GOES), Meteosat, and TDRSS. Several systems are reviewed by Briscoe and Frye (1987), Brooks and Briscoe (1991), and Frye et al. (1991).

Briefly, the polar-orbiting system has the advantage of being able to track large numbers of drifters, but has only limited capability of transferring large amounts of data. For example, Argos can be used to transmit only 32 bytes at 1-minute intervals with the satellite being generally in view for only 10 minutes ten times per day (~3 Kbytes/day) with other factors reducing the data throughput to ~0.1 bit/sec. The Argos satellite communication system is presently used by programs such as the Tropical Ocean Global Atmosphere (TOGA) program to distribute meteorological and physical data in near real-time (e.g., McPhaden, 1988). As indicated earlier, there is a great need to extend near real-time capability to the open ocean. This is true for moorings along with drifters and AUV's. The transmission requirements are relatively severe and beyond the capacity of Argos. For example, if MVMS sampling were done at 4 min intervals for 4 depths, about 650 Kbytes of data would be generated each day. It should be noted that Argos collects less than 3 Kbytes per day and does not provide a command link. The Argos system could handle only a minimal subset of these data. Geosynchronous satellite systems enable transmission rates of 100 bit/sec, but data transmissions are typically limited to once per 1-3 hours giving average data rates of 1 bit/sec. In addition, these systems require ground stations with relatively high power and/or directional antennas (e.g., Brooks and Briscoe, 1991).

Other existing systems include the geostationary Applications Technology Satellite (ATS) which is not expected to be in operation in the future, the commercial INMARSAT Standard C system which requires high power levels and relatively complex antennas (e.g., Brooks and Briscoe, 1991), and the Tracking and Data Relay Satellite System (TDRSS). The latter system was developed under the direction of the National Aeronautics and Space Administration (NASA) at the Goddard Space Flight Center (GSFC) and placed into service during the mid-1980's. The TDRSS provides nearly continuous communications between a ground station located at White Sands, New Mexico and low earth orbiting (LEO) satellites. The system consists of three geostationary (GEO) satellites plus the White Sands Ground Station. One satellite is located over the Atlantic at a longitude which



provides line-of-sight with the ground station at an elevation angle of 5 degrees. The second satellite is located at an equivalent location over the Pacific. The third satellite is an on-orbit spare located over the central continental U.S. With this geometry, the system provides nearly continuous line-of-site communication with LEO satellites with the exception of a 20 degree swath centered 180° from the ground station. This provides a single point for two-way communications without the need for multiple ground stations around the globe. The TDRSS provides three types of communication links: 1) the KSA - single access Ka-band supports up to 300 Mbits/s (Mb/s), 2) the SSA - single access S-band supports up to 10 Mb/s, and 3) MA - multiple access S-band, supports up to 50 Kbits/s (Kb/s). The single access links support one satellite user at a time. The multiple access system can receive telemetered data from up to 20 simultaneous users. This is accomplished by electronically forming 20 separate electronic beams. Each beam has a diameter of 3000 to 4000 miles projected on the surface so point requirements are very coarse. The formed beam permits a 30-fold increase in achievable data rate for a given platform transmitter power. For example, a 4 watt transmitter can support 1 Kb/sec (125 bytes/sec) or 7500 bytes/min. TDRSS has not been utilized for oceanographic data telemetry as yet; however with the development of moderately priced transmitters, it holds great promise.

An alternative system planned by Motorola Corporation is summarized by Brooks and Briscoe (1991). The satellite-based global cellular telephone system, called Iridium, would involve 77 low-orbit satellites which would require only small antennas with low power levels for ground stations (e.g., moorings and drifters). The system data rate capacity is estimated to be ~1000 bits/sec.

Another conceptual satellite system, the global environmental data distribution system (GEDDS), would require a single small satellite operating in a low polar orbit (Walker, 1991). The system would include a command link which would allow investigators to control sampling rates and recalibrate instruments on a daily basis from their laboratories. As with Iridium, the low satellite altitude would permit small antennas and low power levels to be used on the platforms. GEDDS, with a single satellite, would be relatively inexpensive. It would consist of a transponder/processor package mounted on the environmental sensor platform and a satellite package consisting of collection and relay transponders and antennas plus a processor. The system would be controlled from a small ground-based control center which could be located almost anywhere. The satellite would make 14 nominal north-south revolutions per day, interrogating and reading data as it passes over. The GEDDS could collect and distribute over 340 Mbytes of data per day and support over 4000 platforms. Platforms in the temperate zones could be accessed at least three times per day and could transfer from 8 to 800 Kbytes during each access. Platforms in the polar regions not covered by geostationary satellites (e.g., GOES and INMARSAT) could be accessed up to 14 times per day giving a selectable daily throughput of 112 to 11,200 Kbytes. Based on an average of 3 accesses per day at 80 Kbytes per access, an average daily throughput of 240 Kbytes (1,920 Kbits) could be achieved. This corresponds to an approximately 20 bit/s average compared to 0.1 bit/second for Argos. GEDDS could accommodate

from 100 bits/second to 400 bits/s average throughput for selected platforms depending on their location and specific requirements. Finally, GEDDS would use conventional platform hardware and require minimal development. It could be used in conjunction with global positioning satellites (GPS) for location of moving platforms.

To this point, we have addressed the linkage of data from surface-based transmitters to shore either directly or via satellite. The problem of transferring data from subsurface instrumentation to surface transmitters has received increasing attention and is vital to relatively deep instrumentation (e.g., deep moored instruments, AUV's which may not come to the surface frequently, and deep drifters). A direct approach for moorings is to use conducting cable or fiber optical links from subsurface instruments to the surface buoy and transmitter. For relatively shallow instruments (~10-20 m), this approach has been satisfactory; however, for deeper instruments the probability of mechanical damage to the cable or fiber is quite high and the terminations are costly and labor-intensive. Several other subsurface data telemetry approaches have been described by Frye et al. (1991). These include electrical inductive and acoustical telemetry. The inductive method involves a modem and a toroid placed around the mooring cable for coupling of the signal without a direct electrical connection. The signals are detected and amplified by a receiver at the surface. Data rates of ~1,200 bits/s at low power have been reported. Acoustic signal transmission is attractive because of the excellent sound transmission characteristics of water and the available acoustic technology and signal processing capabilities. Complications do arise because of variability in water properties and ambient noise. However, data rates as great as 5,000 bits/s have been achieved with relatively low error rates (Frye et al., 1991).

To review, data communications systems typically used for oceanographic applications have telemetry data rates which are generally too limited for many interdisciplinary systems. However, considerable progress has been made in the areas of subsurface to surface and surface to shore data transmission. In the next few years, it should be possible to adequately transmit a high percentage of interdisciplinary data collected from moorings, drifters, and AUV's in support of programs such as JGOFS and NOAA's global ocean observing system.

## Summary

In summary, automated sampling from moorings, drifters, and AUV's are important for the JGOFS and NOAA programs as they may be used to:

1. Establish relationships between biogeochemical processes (particularly carbon transport from the euphotic layer) and physical forcing;
2. Intercompare several methods for the determination of primary production from moored instrumentation and sediment traps as well as radioisotope methods (e.g.,  $^{234}\text{Th}$ );

3. Make accurate vertical, horizontal, and temporal estimates of pigment biomass and phytoplankton productivity leading to fluxes of carbon;
4. Enhance understanding of relationships between primary production and export of carbon from the upper ocean and to model the flux of carbon through the upper ocean;
5. Maximize the accuracy of future regional and global satellite pigment biomass and phytoplankton productivity estimates.

Many of the present uncertainties in the estimation of carbon budgets are caused by 1) undersampling, both in time and space, 2) limitations in existing measurement techniques involving primary production and sediment trap methodologies (Jahnke, 1990), and 3) the lack of concurrent physical, bio-optical, and biogeochemical data. Observations from moorings, drifters, AUV's, ships, and satellites all have sampling advantages and disadvantages. It is anticipated that the well-planned utilization of these collective platforms will be most useful in reducing many of the present ambiguities and provide new insights into the complicated carbon cycle, thus facilitating the modeling and ultimate prediction of global climate change. Finally, applied coastal problems involving water quality issues and perturbations of the natural ecology can also benefit from the emerging technological capabilities described here.

### Acknowledgements

Special thanks are extended to Mr. Phil Walker for his contribution to the telemetry section and Mr. Derek Manov for useful comments and suggestions. This work is the result of support by the Office of Naval Research (ONR) [N00014-89-J-1498], NOAA Climate and Global Change Program [NA16RC008-01], the Joint Global Flux Study program of the National Science Foundation (NSF) [OCE-9013896], and the University of Southern California Sea Grant program of NOAA [53-4854-8881]. We would also like to thank the French Centre National de la Recherche Scientifique (CNRS) for Dr. Taupier-Letage's support during her year at USC.

### References

- Abbott, M.R., 1992, Scales of bio-optical variability as observed from Lagrangian drifters in the California Current (abs.), Autonomous Bio-optical Ocean Observing Systems (ABOOS) Scientific Symposium, Monterey, CA, April 6-10, 1992.
- Abbott, M.R., K.H. Brink, C.R. Booth, D. Blasco, L.A. Codispoti, P.P. Niiler, and S.R. Ramp, 1990, Observations of phytoplankton and nutrients from a Lagrangian drifter off northern California, *J. Geophys. Res.*, 95, 9393-9409.

- Ackleson, S.G., J.J. Cullen, J. Brown, and M.P. Lesser, 1990, Some changes in the optical properties of marine phytoplankton in response to high light intensity, SPIE, *Ocean Optics X*, 238-249.
- Asper, V.L., 1987, Measuring flux and sinking speed of marine snow aggregates, *Deep-Sea Res.*, 34, 1-17.
- Autonomous Bio-optical Ocean Observing Systems (ABOOS) Scientific Symposium Abstracts, Monterey, CA, April 6-10, 1992.
- Baker, D.J., 1991, Toward a global ocean observing system, *Oceanus*, 34, 76-83.
- Berelson, W.M. and D.E. Hammond, 1986, The calibration of a new free vehicle benthic flux chamber for use in the deep-sea, *Deep-Sea Res.*, 33, 139-145.
- Bidigare, R.R., R.C. Smith, K.S. Baker, and J. Marra, 1987, Oceanic primary production estimates from measurements of spectral irradiance and pigment concentrations, *Global Biogeochemical Cycles*, 1, 171-186.
- Bidigare, R.R., B.B. Prezelin, and R.C. Smith, 1992, Bio-optical models and the problems of scaling, Primary Productivity and Biogeochemical Cycles in the Sea, P. Falkowski (ed.), in press.
- Blidberg, D.R., 1991, Autonomous underwater vehicles: a tool for the ocean, *Unmanned Systems*, 9, 10-15.
- Blidberg, D. R. and G. Sedor, 1992, Report on an interdisciplinary workshop to assess the scientific needs for a long range autonomous underwater vehicle (AUV), Oct. 18-19, 1991, University of New Hampshire, Durham, NH, in press.
- Booth, C.R., B.G. Mitchell, O. Holm-Hansen, 1987, Development of moored oceanographic spectroradiometer, Biospherical Technical Reference 87-1, Biospherical Instruments Inc., San Diego, CA, 69pp, 1987.
- Brewer, P.G., K.W. Bruland, R.W. Eppley, and J.J. McCarthy, 1986, The Global Ocean Flux Study (GOFs): status of the U.S. GOFs Program, *Eos*, 67, 827-832, 835-837.
- Briscoe, M.G. and D.E. Frye, 1987, Motivation and methods for ocean data telemetry, *J. Mar. Technol. Soc.*, 21, 42-57.
- Brooks, D.A. and M.G. Briscoe, 1991, Test of long-range ocean data telemetry using frequency-agile HF packet-switching protocols, *J. Atmos. and Oceanic Tech.*, 8, 856-868.
- Brutzman, D.P. and M.A. Compton, 1991, AUV Research at the Naval Postgraduate School, *Sea Tech.*, 32, 35-40.

- Carder, K.L., R.G. Steward, and T.G. Peacock, 1988, Spectral transmissometer and radiometer: design and initial results, SPIE, *Ocean Optics IX*, 189-195.
- Chavez, F.P., H.W. Jannasch, K.F. Johnson, C.M. Sakamoto, G.E. Friedrich, G.D. Thurmond, and R.H. Herlien, MBARI program for obtaining real-time measurements in Monterey Bay, 1991, in Vol. 1, *Oceans '91 Proceedings*, 327-333.
- Chavez, F.P., R. Herlien, G. Thurmond, D. Wright, and J.T. Pennington, 1992, Real-time mooring systems for interdisciplinary oceanographic research (abs.), Autonomous Bio-optical Ocean Observing Systems (ABOOS) Scientific Symposium Abstracts, Monterey, CA, April 6-10, 1992. Churchill, J.H., P.E. Biscaye, and F. Aikman, 1988, The character and motion of suspended particulate matter over the shelf edge and upper slope off Cape Cod, *Cont. Shelf. Res.*, 8, 789-809.
- Clark, D.K., W.W. Broenkow, and M.A. Yarbrough, 1992, Prototype marine optical buoy system (abs.), Autonomous Bio-optical Ocean Observing Systems (ABOOS) Scientific Symposium Abstracts, Monterey, CA, April 6-10, 1992.
- Cowles, T.J., R.A. Desiderio, J.N. Moum, M.L. Myrick, and S.M. Angel, 1990, Fluorescence microstructure using a laser/fiber optic profiler, *Proc. SPIE-Int. Soc. Opt. Eng.*, 1302, 336-345.
- Cullen, J.J., E. Stewart, E. Renger, R.W. Eppley, and C.D. Winant, 1983, Vertical motion of the the thermocline, nutricline, and chlorophyll maximum layers in relation to currents on the southern California shelf, *J. Mar. Res.*, 41, 239-262.
- Cullen, J.J., M.R. Lewis, C.O. Davis, and R.T. Barber, 1991, Photosynthetic characteristics and estimated growth rates of phytoplankton in the equatorial Pacific, *J. Geophys. Res.*, 97, 639-655.
- Dickey, T. D., 1988, Recent advances and future directions in multi-disciplinary in situ oceanographic measurement systems, in *Toward a Theory on Biological and Physical Interactions in the World Ocean*, B. Rothschild (ed.), Kluwer Academic, Dordrecht, The Netherlands, 555-598.
- Dickey, T., 1991, The emergence of concurrent high-resolution physical and bio-optical measurements in the upper ocean, *Rev. of Geophys.*, 29, 383-413.
- Dickey, T.D. and D.V. Manov, 1991, Moored systems for time series observations of bio-optical and physical variability in the coastal ocean, Coastal Zone '91, Proc. of 7th Symposium on Coastal and Ocean Management, ASCE, Long Beach, California, 86-100.

- Dickey, T.D. and J.C. Van Leer, 1984, Observations and simulation of a bottom Ekman layer on a continental shelf, *J. Geophys. Res.*, 89, 1983-1988.
- Dickey, T.D., D.A. Siegel, A. Bratkovich, and L. Washburn, 1986, Optical features associated with thermohaline structures, *Proc. SPIE-Int. Soc. Opt. Eng.*, 637, 308-313.
- Dickey, T., J. Marra, T. Granata, C. Langdon, M. Hamilton, J. Wiggert, D. Siegel, and A. Bratkovich, 1991, Concurrent high resolution bio-optical and physical time series observations in the Sargasso Sea during the spring of 1987, *J. Geophys. Res.*, 96, 8643-8663.
- Dickey, T., T. Granata, J. Marra, C. Langdon, J. Wiggert, Z. Chai, M. Hamilton, J. Vazquez, M. Stramska, R. Bidigare, and D. Siegel, 1992a, Seasonal variability of bio-optical and physical properties in the Sargasso Sea, submitted to *J. Geophys. Res.*
- Dickey, T., J. Marra, M. Stramska, C. Langdon, T. Granata, A. Plueddemann, and R. Weller, 1992b, Bio-optical and physical variability in the northwest Atlantic Ocean (59°N 21°W) during the spring of 1989, to be submitted to *J. Geophys. Res.*
- Dugdale, R.C., and J.J. Goering, 1967, Uptake of new and regenerated forms of nitrogen in primary productivity, *Limnol. and Oceanogr.*, 12, 196-206.
- Dunn, S.E., 1991, Unmanned, untethered vehicles in ocean engineering, *Unmanned Systems*, 9, 39-40.
- Esaias, W.E., S.B. Hooker, C.R. McClain, G.C. Feldman, and W.W. Gregg, 1992, SeaStar/SeaWiFS: ocean color data for the 1990s (abs.), Autonomous Bio-optical Ocean Observing Systems (ABOOS) Scientific Symposium Abstracts, Monterey, CA, April 6-10, 1992.
- Evans, R.H., 1992, Implementation of a satellite in situ observation match-up database - a prerequisite for development and validation of satellite algorithms (abs.), Autonomous Bio-optical Ocean Observing Systems (ABOOS) Scientific Symposium Abstracts, Monterey, CA, April 6-10, 1992.
- Falkowski, P.G., C.N. Flagg, G.T. Rowe, S.L. Smith, T.E. Whitley, and C.D. Wirick, 1988, The fate of the spring phytoplankton bloom: export or oxidation?, *Cont. Shelf Res.*, 8, 457-484.
- Falkowski, P.G., Ziemann, Z. Kolber, and P.K. Bienfang, 1991, Role of eddy pumping in enhancing primary production, *Nature*, 352, 55-58.
- Flagg, C.N., 1988, Internal waves and mixing along the New England shelf-slope front, *Cont. Shelf Res.*, 8, 737-756.

- Flagg, C.N. and S.L. Smith, 1989, On the use of the acoustic Doppler current profiler to measure zooplankton abundance, *Deep-Sea Res.*, 36, 455-474.
- Frye, D.E., W.B. Owens, and J.R. Valdes, 1991, Ocean data telemetry: new methods for real-time ocean observations, *Oceanus*, 34, 46-52.
- Fukuchi, M. H. Hattori, H. Sasaki, and T. Hoshai, 1988, A phytoplankton bloom and associated processes observed with a long-term moored system in Antarctic waters, *Mar. Ecol. Prog. Ser.*, 45, 279-288.
- Gardner, W.D. and I.D. Walsh, 1990, The role of aggregates in horizontal and vertical flux across a continental margin, *Deep-Sea Res.*, 37, 401-412.
- Gardner, W.D., M.J. Richardson, I.D. Walsh, and B.L. Berglund, 1990, In situ optical sensing of particles for determination of oceanic processes, *Oceanography*, November, 1990, 11-17.
- Hamilton, M., T. Granata, T. Dickey, J. Wiggert, D. Siegel, and J. Marra, 1990, Diurnal variations of bio-optical properties in the Sargasso Sea, SPIE, *Ocean Optics X*, 214-224.
- Haury, L.R. and R.E. Pieper, 1987, Zooplankton: scales of biological and physical events, in *Marine Organisms as Indicators*, eds. D.F. Soule and G.S. Kleppel, Springer-Verlag, New York, 35-72.
- Hitchcock, G.L. and D.B. Olson, 1992, Lagrangian sampling platforms for bio-optical properties (abs.), *Autonomous Bio-optical Ocean Observing Systems (ABOOS) Scientific Symposium Abstracts*, Monterey, CA, April 6-10, 1992.
- Hitchcock, G.L., E.J. Lessard, D. Dorson, J. Fontaine, and T. Rossby, 1989, The IFF: the isopycnal float fluorometer, *J. Atmos. Oceanic Tech.*, 6, 19-25.
- Honjo, S., R. Krishfield, and A. Plueddemann, 1990, The Arctic Environmental Drifting Buoy (AEDB), Report of field operations and results: August, 1987-April 1988, Woods Hole Oceanographic Institution Technical Report, WHOI 90-02, 128 pp.
- Hooker, S.B. and W.E. Esaias, An overview of the SeaWiFS project, NASA Technical Memorandum, SeaWiFS Technical Report Series, S.B. Hooker ed., preprint.
- Iturriaga, R., R. Bartz, and J.R.V. Zaneveld, 1990, An in situ active fluorometer to measure coccoid cyanobacteria fluorescence, SPIE, *Ocean Optics X*, 346-354.
- Jahnke, R.A., 1990, Ocean flux studies: a status report, *Rev. of Geophys.*, 28, 381-398.

- Jannasch, H.W. and K.S. Johnson, 1991, Instrumentation for in-situ analyses of dissolved nutrients and trace metals in seawater, MarChem '91, Steamboat Springs, Colorado, June 9-13, 1991.
- Johnsen, G., O. Samset, and Z. Volent, 1992, Optical characteristics of phytoplankton in relation to remote sensing (abs.), Autonomous Bio-optical Ocean Observing Systems (ABOOS) Scientific Symposium Abstracts, Monterey, CA, April 6-10, 1992.
- Karl, D. and C. Winn, 1991, A sea of change: monitoring the oceans' carbon cycle, *Environ. Science Tech.*, 25, 1976-1981.
- Keeling, C.D. and T.P. Whorf, 1990, Atmospheric carbon dioxide concentrations, Mauna Loa, TRENDS '90: A compendium of data on global change, ONRL/CDIAC-36, T.A.A. Boden, P. Kanciruk, and M.P. Farrell (eds.), Carbon Dioxide Information and Analysis Center, Oak Ridge, Tennessee, 8-9.
- Kiefer, D.A., 1973, Fluorescence properties of natural phytoplankton populations, *Mar. Biol.*, 22, 263-269, 1973.
- Kiefer, D. A. and B. G. Mitchell, 1983, A simple, steady-state description of phytoplankton growth based on absorption cross section and quantum efficiency, *Limnol. Oceanogr.*, 28, 770-776.
- Kiefer, D. A., W. S. Chamberlin, and C. R. Booth, 1989, Natural fluorescence of chlorophyll a: relationship to photosynthesis and chlorophyll concentration in the western South Pacific gyre, *Limnol. and Oceanogr.*, 34, 868-881.
- Kimoto, T., 1992, Development of continuous observation systems related to red tides: past and future (abs.), Autonomous Bio-optical Ocean Observing Systems (ABOOS) Scientific Symposium Abstracts, Monterey, CA, April 6-10, 1992.
- Kimoto, T. and T. Fujinaga, 1990, Non-biotic synthesis of organic polymers on H<sub>2</sub>S-rich sea-floor: a possible reaction in the origin of life, *Mar. Chem.*, 30, 179-192. Knap, A.H., A.F. Michaels, R.L. Dow, R.J. Johnson, K. Gundersen, G.A. Knauer, S.E. Lohrenz, V.A. Asper, M. Tuel, H. Ducklow, H. Quinby, and P. Brewer, 1990, Data Report for BATS 1 - BATS 6, U.S. JGOFS, Bermuda Atlantic Time-series Study, Bermuda Biological Station for Research, Inc., 110 pp.
- McCartney, B.S. and P.G. Collar, 1990, Autonomous submersibles-instrument platforms of the future, *Underwater Technology*, 15, 19-25.
- McLean, S.D., A.M. Ciotti, and M.R. Lewis, 1992, An expendable spectral radiometer (ESR) drifter buoy-field trials (abs.), Autonomous Bio-optical Ocean Observing Systems (ABOOS) Scientific Symposium Abstracts, Monterey, CA,



- April 6-10, 1992. McPhaden, M.J., 1988, PMEL current meter mooring program in the tropical Pacific, Pacific Planning Report of the U.S. GOFS 3rd Pacific Planning Meeting, U.S. GOFS Planning Report No. 9, Feb. 1988, Monterey, California, Meeting, 91-94.
- Marra, J., R. Bidigare, and T. Dickey, 1990, Nutrients, and mixing, chlorophyll, and phytoplankton growth, *Deep-Sea Res.*, 37, 127-143.
- Marra, J., T. Dickey, W.S. Chamberlin, C. Ho, C. Langdon, R. Smith, K. Baker, R. Bidigare, M. Hamilton, T. Granata, and D.A. Kiefer, 1992, Seasonal primary production in the Sargasso Sea: an optical view, submitted to *Journal of Geophysical Research*.
- Matsumura, H. Masuko, H. Kawamura, M. Kishino, I. Asanuma, S. Saitoh, M. Shimanuki, and M. Utashima, McCartney, B.S. and P.G. Collar, 1990, Autonomous submersibles-instrument platforms of the future, *Underwater Technology*, 15, 19-25.
- Medeiros, W.H. and C.D. Wirick, 1992, Shelf Edge Exchange Processes (SEEP-II) : Chlorophyll a fluorescence, temperature, and beam attenuation measurements from moored fluorometers, 1992, Brookhaven National Laboratory Informal Report 47211, 202 pp.
- Michaels, A.F. and A.H. Knap, 1992, Ocean time-series near Bermuda: Hydrostation S and the U.S. JGOFS Bermuda Atlantic Time-Series study, submitted to Ocean Climate Data Workshop Proc., Goddard Space Flight Center, Greenbelt, MD, Feb. 18-21, 1992,
- Michaels, A.F., A.H. Knap, R.L. Dow, K. Gundersen, R.J. Johnson, J. Sorensen, A. Close, G. Knauer, S.E. Lohrenz, V.A. Asper, M. Tuel, and R. Bidigare, 1992, Ocean time-series measurements off of Bermuda: the first two years of the U.S. JGOFS Bermuda Atlantic Time-series Study, submitted to *Deep-Sea Res.*
- Morel, A., 1991, Light and marine photosynthesis: a spectral model with geochemical and climatological implications, *Prog. Oceanogr.*, 26, 263-306.
- Morrow, J.H., D.A. Kiefer, B.N. White, and C.R. Booth, 1992, An unattended remote optical sensor for water quality: REOS-2, McCartney, B.S. and P.G. Collar, 1990, Autonomous submersibles-instrument platforms of the future, *Underwater Technology*, 15, 19-25.
- Mueller, J.L. and R.W. Austin, Ocean optics protocols for SeaWiFS validation, SeaWiFS Technical Report Series, S.B. Hooker ed., preprint.
- Niiler, P.P., R.E. Davis, and H.J. White, 1988, Water-following characteristics of a mixed layer drifter, *Deep-Sea Res.*, 34, 1867-1881.

- Olson, D.B., 1992, The global circulation and ocean optics (abs.), Autonomous Bio-optical Ocean Observing Systems (ABOOS) Scientific Symposium Abstracts, Monterey, CA, April 6-10, 1992.
- Pappas, G., W. Shotts, M. O'Brien, and W. Wyman, 1991, The DARPA/Navy unmanned undersea vehicle program, *Unmanned Systems*, 9, 24-30.
- Pieper, R.E., D.V. Holliday, and G.S. Kleppel, 1990, Quantitative zooplankton distributions from multifrequency acoustics, *J. Plankton Res.*, 12, 433-441.
- Plueddemann, A.J. and R. Pinkel, 1989, Characterization of the patterns of diel migration using a Doppler sonar, *Deep-Sea Res.*, 36, 509-530.
- Sarachik, E.S. and R.H. Gammon, 1989, The role of the ocean in the NOAA program "Climate and Global Change," NOAA Climate and Global Change Program Special Report No. 1, produced by UCAR, 49 pp.
- Siegel, D. A., T. D. Dickey, L. Washburn, M. K. Hamilton, and B. G. Mitchell, 1989, Optical determination of particulate abundance and production variations in the oligotrophic ocean, *Deep-Sea Res.*, 36, 211-222.
- Smith, R.C., C.R. Booth, and J.L. Star, 1984, Oceanographic bio-optical profiling system, *Appl. Opt.*, 23, 2791-2797.
- Smith, R.C., K.J. Waters, and K.S. Baker, 1991, Optical variability and pigment biomass in the Sargasso Sea as determined using deep sea optical mooring data, *J. Geophys. Res.*, 96, 8665-8686.
- Stramska M. and T. D. Dickey, 1992a, Short-term variations of the bio-optical properties of the ocean in response to cloud-induced irradiance fluctuations, *J. Geophys. Res.*, 97, 5713-5722.
- Stramska M. and T. D. Dickey, 1992b, Variability of bio-optical properties of the upper ocean associated with diel cycles in phytoplankton population, submitted to *Journal of Geophysical Research*.
- U.S. GOFS Planning Report No. 4, 1986, Modeling in GOFS, U.S. JGOFS Planning Office, Woods Hole, Massachusetts, 142 pp.
- U.S. GOFS Planning Report No. 8, 1988, Data Management, U.S. JGOFS Planning Office, Woods Hole, Massachusetts, 52 pp.
- U.S. JGOFS Planning Report no. 11, 1990, Long Range Plan, U.S. JGOFS Planning Office, Woods Hole, Massachusetts.
- U.S. JGOFS Planning Report no. 14, 1992, Modeling and Data Assimilation, U.S. JGOFS Planning Office, Woods Hole, Massachusetts.

- Van Leer, J.C. and J.Z. Villanueva, 1986, Observations of potentially double-diffusive convective layers in Fram Strait (abs.), *EOS*, 67, 1015.
- Volent, Z. and G. Johnsen, 1992, Presentation of an optical algae sensor "OPTISENS" designed for Eulerian measurements from a moored buoy (abs.), Autonomous Bio-optical Ocean Observing Systems (ABOOS) Scientific Symposium Abstracts, Monterey, CA, April 6-10, 1992.
- Walker, P.C., 1991, A global environmental data distribution system, Proc. of the Fifth Annual AIAA/USU Conference on Small Satellites, August 26-29, 1991, Las Vegas, Nevada.
- Walker, P.C. and R.H. Douglass, 1992, Duplex communications with unattended data buoy (abs.), Autonomous Bio-optical Ocean Observing Systems (ABOOS) Scientific Symposium Abstracts, Monterey, CA, April 6-10, 1992. Walsh, I.D., 1990, Project CATSTIX: camera, transmissometer, and sediment trap integration experiment, Ph.D. Dissertation, Texas A&M University, 96 pp.
- Walsh, J.J., C.D. Wirick, L.J. Pietrafesa, T.E. Whitley, F.E. Hoge, and R.N. Swift, 1988, High-frequency sampling of the 1984 spring bloom within the Mid-Atlantic Bight: synoptic shipboard, aircraft, and in situ perspectives of the SEEP-I experiment, *Cont. Shelf. Res.*, 8, 529-563.
- White, B.N., D.A. Kiefer, J. H. Morrow, and G.F. Stolarik, 1991, Remote biological monitoring in an open finished-water reservoir, *J. Amer. Water Works Assoc.*, 83, 107-112.
- Whitley, T.E. and C.D. Wirick, 1983, Observations of chlorophyll concentrations off Long Island from a moored in situ fluorometer, *Deep-Sea Res.*, 30, 297-309.
- Whitley, T.E. and C.D. Wirick, 1986, Development of a moored in situ fluorometer for phytoplankton studies, Lecture Notes on Coastal and Estuarine Studies, 17, in Tidal Mixing and Plankton Dynamics, J. Bowman, M. Yentsch, and W.T. Peterson (eds.), Springer-Verlag, Berlin Heidelberg, 449-462.
- Weidemann, A. and R. Hollman, 1992, Performance evaluation of expendable K(490) probes (abs.), Autonomous Bio-optical Ocean Observing Systems (ABOOS) Scientific Symposium Abstracts, Monterey, CA, April 6-10, 1992.
- Wilkerson, F.P. and R.C. Dugdale, 1987, The use of large shipboard barrels and drifters to study the effects of coastal upwelling on phytoplankton dynamics, *Limnol. Oceanogr.*, 32, 368-382.
- Wirick, C.D., 1992, Decade of moored fluorescence observations on continental shelves (abs.), Autonomous Bio-optical Ocean Observing Systems (ABOOS) Scientific Symposium Abstracts, Monterey, CA, April 6-10, 1992.

Woods, J., 1991a, Report of the Institute of Oceanographic Sciences Deacon Laboratory 1990/1991, J. Woods (ed.), Wormley, United Kingdom, 36 pp.

Woods, J., 1991b, Oceanographic instrumentation present and future, *Underwater Systems Design*.

Yoder, J.A., W.E. Esaias, G.C. Feldman, and C.R. McClain, 1988, Satellite ocean color - status report, *Oceanography*, 1, 18-20.

Yoerger, D.R., A.M. Bradley, and B.B. Walden, 1991, The autonomous benthic explorer, *Unmanned Systems*, 9, 17-23.

Table I. Interdisciplinary Mooring Studies.

Study	Location	Experimental Period	Days	Depths	Variables	No. Variables	Int. (min)	Data Amount	Reference
Long Island*	(1) Long Island Shelf (40N, 72W)	Aug.-Sept. 77	21	1	t,U,V,T,C,Fl	6	20	36Kbytes	Whitledge & Winck (1983)
SEEP Pilot**	(1) Long Island Shelf (40N, 72W) Maryland Shelf (37N, 74W)	July 82	6	1	t,T,Fl,c,p	5	8	48Kbytes	Whitledge & Winck (1986)
		Apr. 83	7	1					
SEEP***	(1) Long Island Shelf and Martha's Viny. (-40N, 71-72W) Maryland Shelf (37N, 74W)	Sept. 83-Mar. 84	330	5**	t,U,V,T,C,Fl,c  t,T, Fl, c (PAR, DO)	7	16 to 20 34 to 68	Roughly 3Mbytes  Roughly 18Mbytes	Walsh et al. (1988) Falkowski et al. (1988) Churchill et al. (1988) Flagg (1988) Medeiros & Winick (1992)
		Apr.-Oct. 84	415	2-3					
		Feb. 88 - May 89							
Scripps Canyon*	(2) Scripps Canyon (33N 117W)	Apr.-May. 84 Nov. 85-Jun. 86	300	1	t,U,V,T,C,p,c,Fl, Ed( $\lambda$ ),E <sub>u</sub> ( $\lambda$ ),L <sub>u</sub> ( $\lambda$ )	40	5	14Mbytes	Booth et al. (1987)
Antarctica	(3) Antarctica (70S, 24E)	Dec. 85-Feb. 86	47	1	t,U,V,T,p,Fl	6	60	27Kbytes	Fukuchi et al. (1988)
Biowatt (MVMS)	(4) Sargasso Sea (34N, 70W)	Mar.-Nov. 87	265	8	t,U,V,T, C,PAR, c,Fl,DO	9	4	24Mbytes	Dickey et al. (1991)
Biowatt (BOMS)	(4) Sargasso Sea (34N, 70W)	Mar.-Nov., 87	265	2 or 3	t,Ed( $\lambda$ ),L <sub>u</sub> ( $\lambda$ ),T,p	13	4	10Mbytes	Smith et al. (1991)
MLML I (MVMS)	(5) South of Iceland (59N, 21W)	Apr.-Jun., 89	60	8	t,U,V,T, C,PAR, L <sub>u</sub> (683),c,Fl,DO	10	1	31Mbytes	Dickey (1991) Dickey & Marra (in progress)
MLML II (MVMS)	(5) South of Iceland (59N, 21W)	May-Sept., 91	126	8	t,U,V,T, C,PAR, L <sub>u</sub> (683),c,Fl,DO	10	1	65Mbytes	Dickey & Marra (in progress)
MLML II (BOMS)	(5) South of Iceland (59N, 21W)	May-Sept. 91	126	3	t,Ed( $\lambda$ ),L <sub>u</sub> ( $\lambda$ ), T,p,c,Fl	15	4	8Mbytes	Smith et al. (in progress)
Ocean Outfall I (MVMS)	(6) Los Angeles Coast (118N, 34N)	Jan.-Feb. 91	51	2	t,U,V,T, C,PAR, L <sub>u</sub> (683),c,Fl,DO t,U,V,T, c,p	10	1	10Mbytes	Dickey & Manov (1991)
				2					
Ocean Outfall II* (MVMS)	(6) Los Angeles Coast (118N, 34N)	Jan.-Feb. 92	40	2	t,U,V,T, C,PAR, L <sub>u</sub> (683),c,Fl,DO t,U,V,T, c,p	10	1	8Mbytes	Dickey et al. (in progress)
				2					
OASIS*	(7) Monterey Bay, CA (37N, 123W)	In progress	-	2	t,U,V,T,C,c,Fl Ed( $\lambda$ ),L <sub>u</sub> ( $\lambda$ )	17	15	-	Chavez et al. (1992, work in progress)
GCC/JGOFS (MVMS)	(8) Equat. Pacific (0, 140W)	Nov. 91-Apr. 92	180	4	t,U,V,T, C,PAR, L <sub>u</sub> (683),c,Fl,DO	10	3.75	11Mbytes	Dickey et al.
GCC/JGOFS (MVMS)	(8) Equat. Pacific (0, 140W)	Apr. 92-Nov. 92	180	4	t,U,V,T, C,PAR, L <sub>u</sub> (683),c,Fl,DO	10	3.75	11Mbytes	Dickey et al.

(Continued on next page)

Study	Location	Experimental Period	D a y s	D e p t h s	Variables	N o . V a r .	Int. (min)	Data Amount	Reference
OPTISENS	(9) Norwegian Coast	1988-present	?	1	t, c(470,555,650)	4	?	?	Volent & Johnsen (1992)
Miscellaneous Fluorometer/ Current meter Moorings	(10) Bering and Chukchi Seas (62-68°N) (11) Georgia Cont. Shelf (12) Gulf of Eilat in Red Sea	Unknown	?	?	Fluorescence Currents	4?	?	?	Wirick (1992)
Prototype Mar. Optical Buoy System*	(13) Hawaii (open ocean)	Planned	N/A	Near Sfc.	2 spectrographs: radiometric meas. with high spectral resolution & stray light rejection	?	?	?	Clark et al. (1992)
Red Tides****	(14) Osaka Bay (15) Lake Biwa	1988-1991 1990-present	?	(0-20m) (0-100m)	t, T, S, pH, DO, c, nuts., Chl	13	?	?	Kimoto et al. (1990) Kimoto (1992)
ADBOS Buoy*	(16) Tokyo Bay (17) Yamato Bank	Dec. 1991-present Planned	?	1 2	t, Chl, E <sub>d</sub> (λ), L <sub>u</sub> (λ) same as above	12 12	?	?	Matsumura et al. (1992)
REOS*	(18) Los Angeles reservoir*	1990-1992	600	1	t, Nat. Fluor., T, c PAR, DO, pH, Cond.	9	5 & 15	3Mbytes	White et al. (1991) Morrow et al. (1992)
Expendable Spect. Rad. (moor. tests)	(19) Bedford Basin	1992	?	1	t, L <sub>u</sub> (λ), sfc E <sub>d</sub> (490), SST	10	?	?	McLean et al. (1992)

\* Indicates telemetry was used.

\*\* Sensors were not necessarily co-located.

\*\*\* The SEEP project utilized up to 10 moorings. Sensors were placed at several depths, but were not necessarily co-located, therefore the estimates of data amounts are not computed in the same manner as sensor suite data. The reader is directed to the references for details concerning the actual experimental parameters.

\*\*\*\* Barge or mooring buoy used.

Table 1. Interdisciplinary mooring studies including locations, sampling periods, duration of sampling in days, number of depths of instruments, variables sampled, number of variables, sampling intervals (int. = 1/rate), data amounts in bytes, and references.

Study	Location	Experimental Period	D a y s	D e p t h s	Variables	N o . V a r .	Int. (min)	Data Amount	Reference
(20) MVP*	(20) Sargasso Sea & Tongue of the Ocean	Spring 1985	10	10-300m	t, T, cond., currents, Fl, PAR	7	0.3 hourly profile	1.2Mbytes	Dickey (1988) Marra et al. (1990)
(21) IFF**,**	(21) Gulf Stream (37N, 73W)	Sept. 1986	4	Var.	t, T, Fl, p	4	1.5	61Kbytes	Hitchcock et al. (1989)
(22) CTZ	(22) Central Calif. Coast (38N, 125W)	Jun. 87	4	1	t, T, c, Fl, p E <sub>d</sub> (λ), L <sub>u</sub> (λ)	15	4	173Kbytes	Abbott et al. (1990)
(23) AEDB*	(23) Arctic (65-87N, 20E-30W)	Aug. 87-Apr. 88	255	2**	t, U, V, T, Fl, c, p	7	60	343Kbytes	Honjo et al. (1990)

\* Indicates telemetry was used.

\*\* The Isopycnal Float Fluorometer (IFF) system follows isopycnal surfaces and thus varies in water depth (~40-80m for this study).

Table 2. Interdisciplinary drifter/float studies with information as described in Table 1.

**Table 3. Summary of Hypothetical Future Annual Global Interdisciplinary Studies.**

Study	Number	Days	Depths	Variables	No. Variables	Int. (min)	Data Amount
Moorings	30	365	4	t,U,V,T,C,p,c,Fl, DO,pCO <sub>2</sub> ,nuts., PAR,E <sub>d</sub> (λ),L <sub>u</sub> (λ)	24	1	6Gbytes
Drifters (incl. Floats)	200	365	2	t,T,C,p,c,Fl,DO, pCO <sub>2</sub> ,nuts.,PAR, E <sub>d</sub> (λ),L <sub>u</sub> (λ)	22	1	18Gbytes
AUV's	10	365	Var. (1 unit)	t,T,C,p,c,Fl,DO, pCO <sub>2</sub> ,nuts.,PAR, E <sub>d</sub> (λ),L <sub>u</sub> (λ)	22	1	464Mbytes
<b>Total</b>	<b>225</b>	<b>365</b>					<b>25Gbytes</b>

Table 3. Hypothetical interdisciplinary mooring, drifter/float, and AUV studies which could be done over the world oceans with information as described in Table 1.

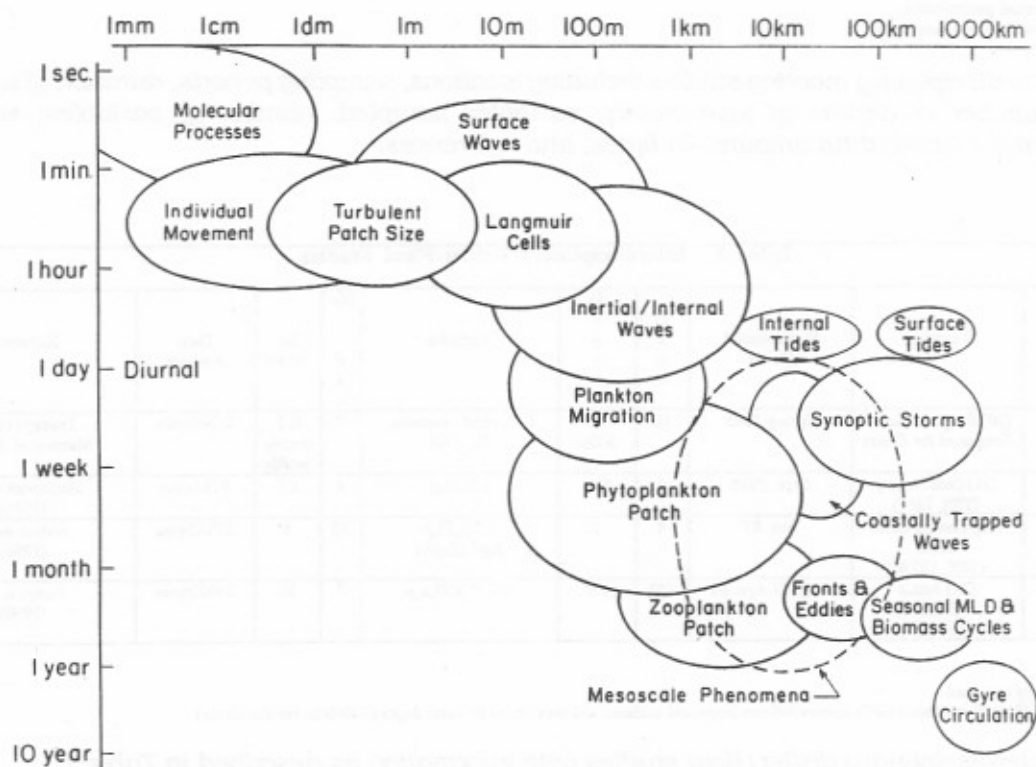

Figure 1. A schematic diagram illustrating the relevant time and space scales of several physical and biological processes important to the physics, biogeochemistry, and ecosystems of the upper ocean (after Dickey, 1991).

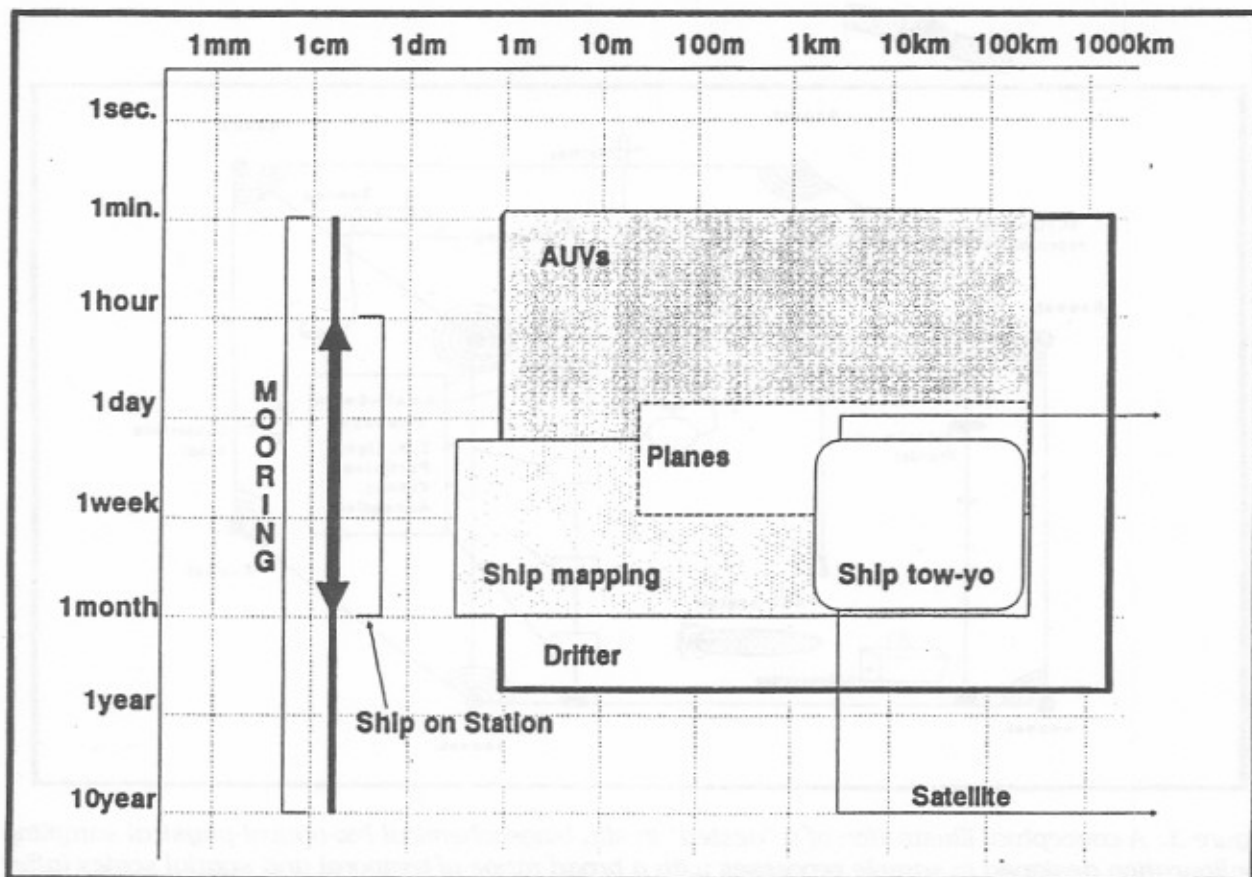

Figure 2. Temporal and horizontal spatial sampling coverage of several platforms (based on Dickey, 1991; after Bidigare et al., 1992).

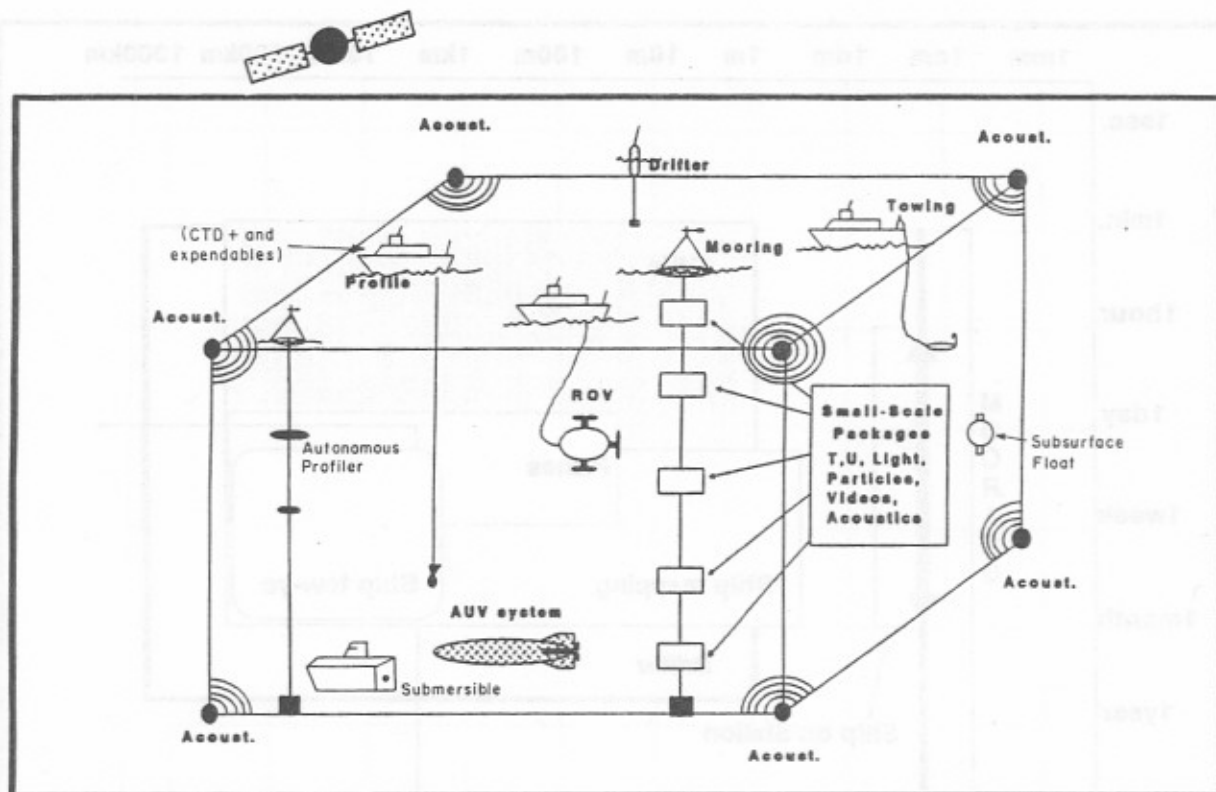

Figure 3. A conceptual illustration of a "nested" in situ biogeochemical-bio-optical-physical sampling configuration designed to sample processes with a broad range of temporal and spatial scales (after Dickey, 1991).



### DETERMINING BIO-OPTICAL PROPERTIES (x,y,z,t)

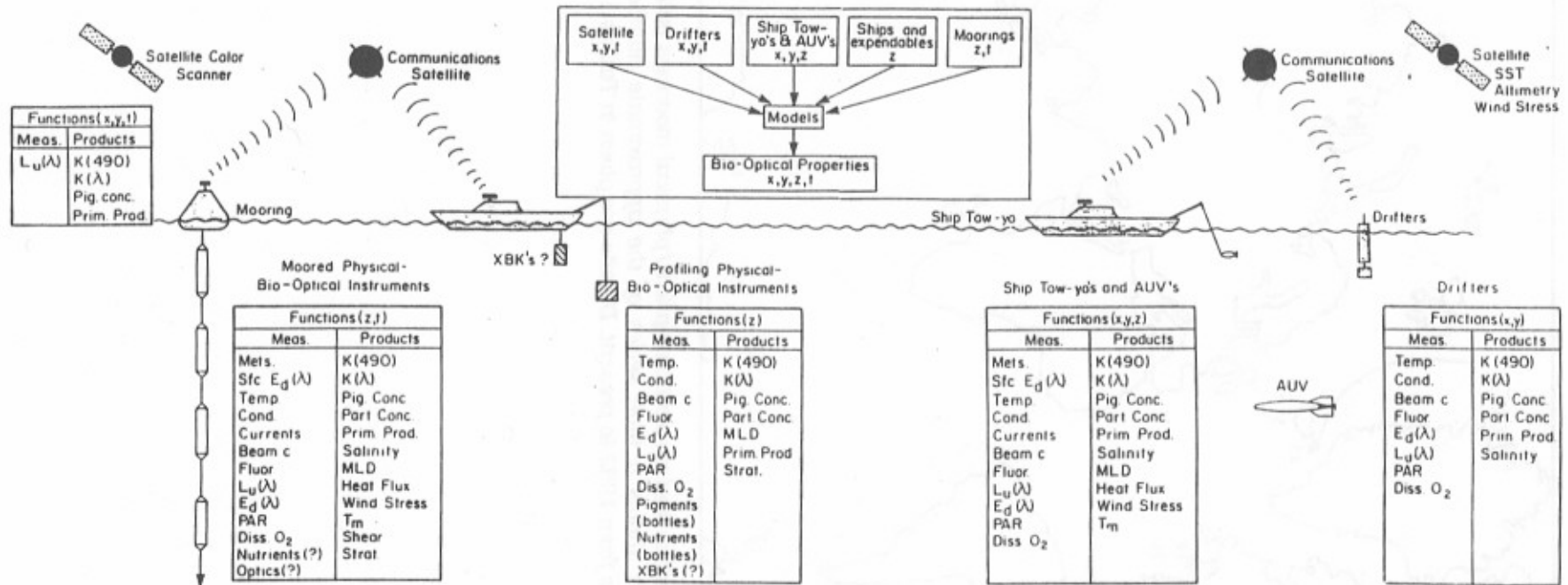

Figure 4. A schematic illustrating a methodology for determining the variability of bio-optical properties in space and time on a global basis using satellite as well as in situ data sets along with appropriate models. Applications could include determinations of the subsurface light field, primary production, particulate carbon fluxes, and the penetrative component of solar radiation (based on Dickey, 1991).

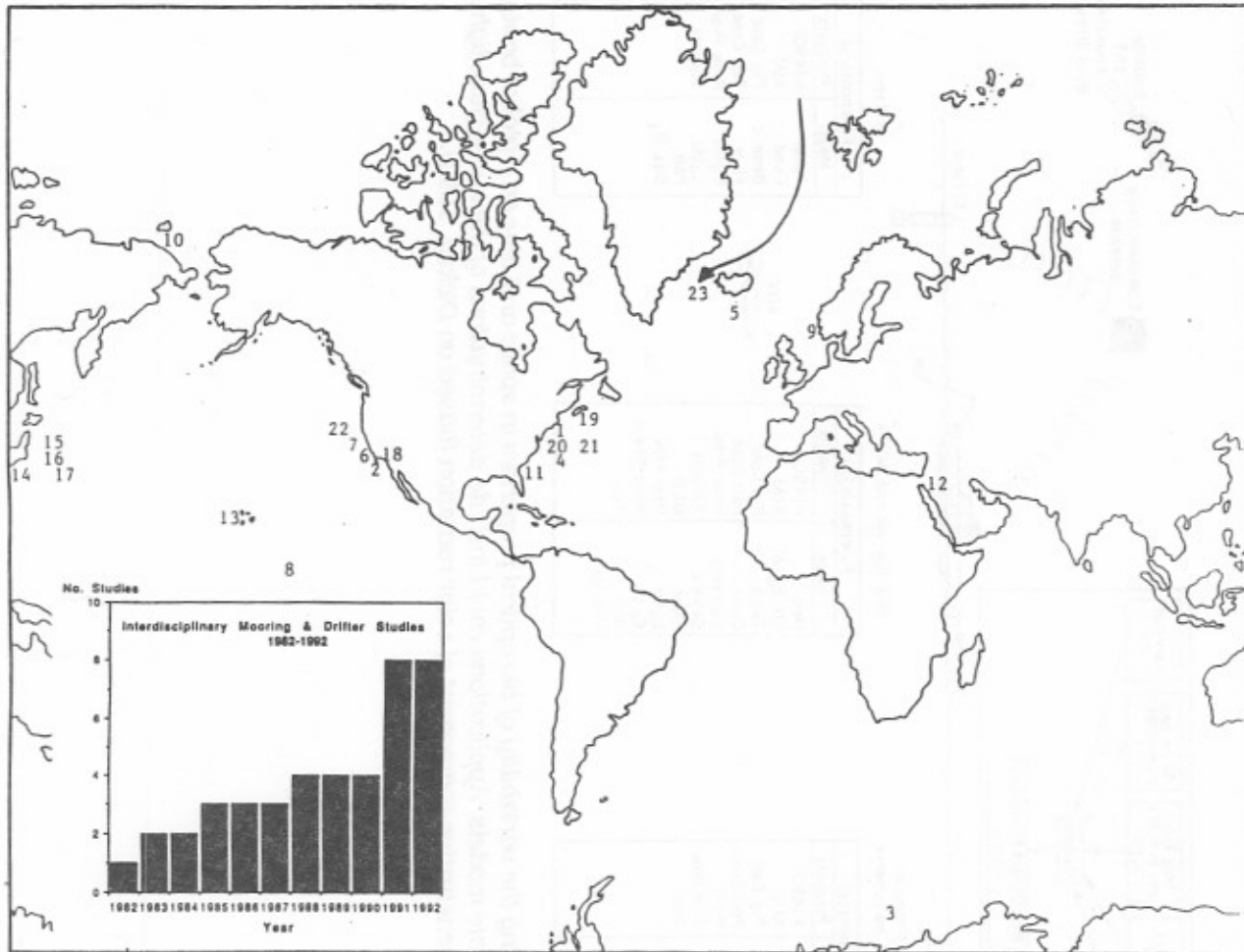

Figure 5. World map indicating sites of previous and present bio-optical/physical moorings (sites 1-19) and drifters (sites 20-23). The insert shows a time series of the approximate number of interdisciplinary mooring and drifter studies from 1982 to present. Details are given in Tables 1 and 2.

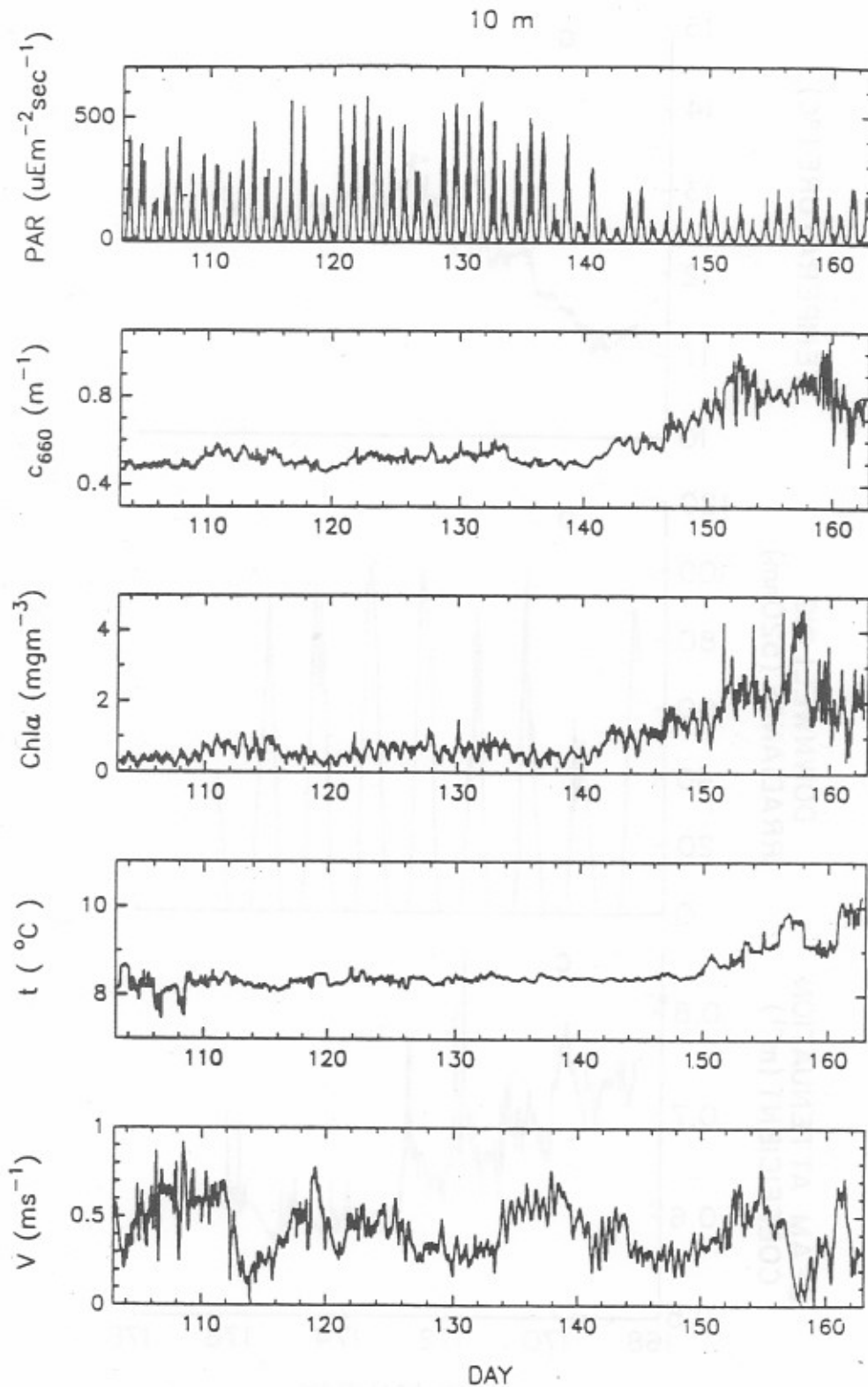

Figure 6. Time series of physical and bio-optical data taken from an MVMS located at 10m on a mooring south of Iceland (59N 21W) in April 1989. Time series include: photosynthetic available radiation or PAR ( $\mu\text{E m}^{-2} \text{s}^{-1}$ ), beam attenuation coefficient at 660nm, stimulated chlorophyll fluorescence ( $\text{mg m}^{-3}$ ), temperature ( $^{\circ}\text{C}$ ), and current speed ( $\text{m s}^{-1}$ ). Sampling rate was once per minute. (Dickey et al., 1992b).

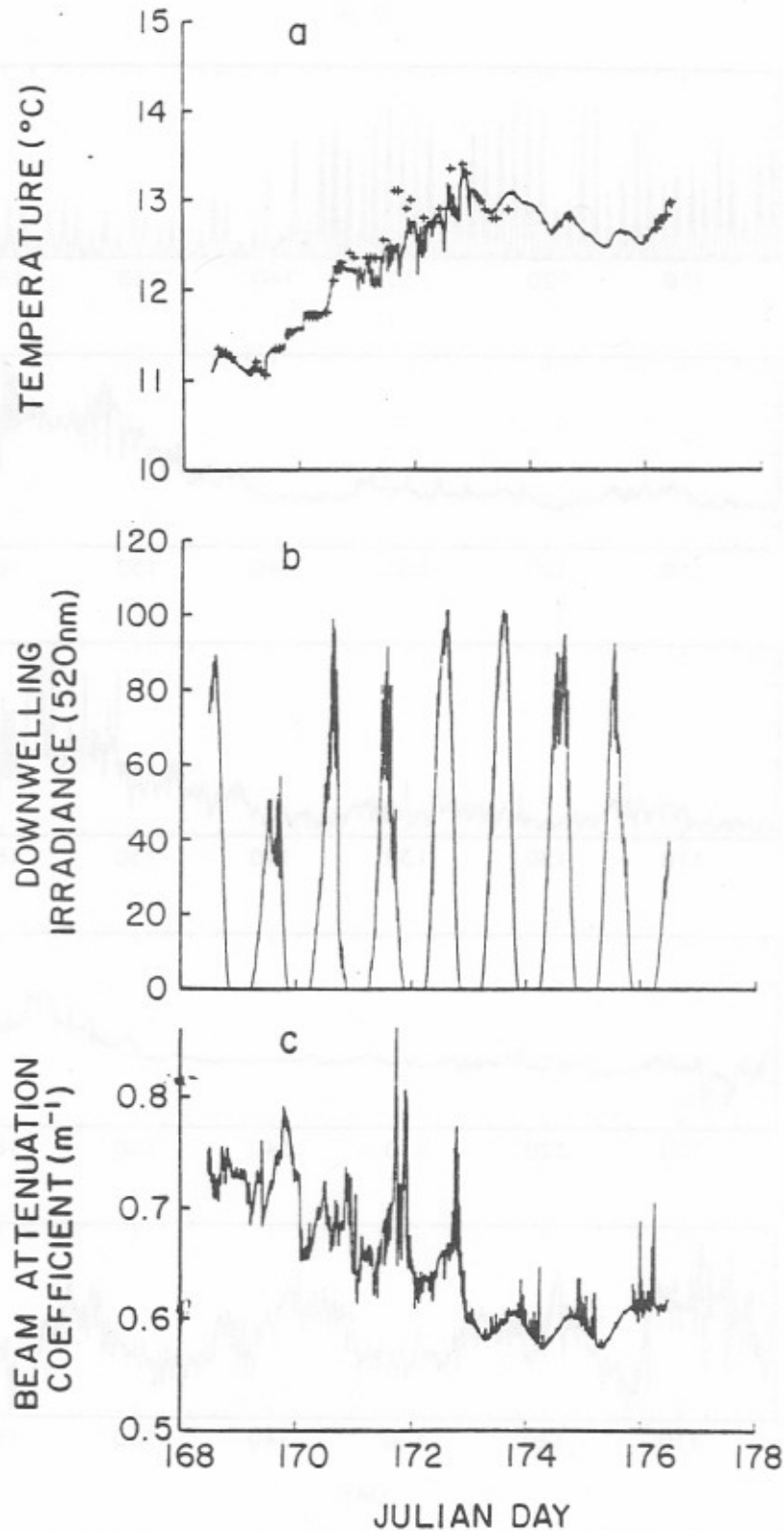
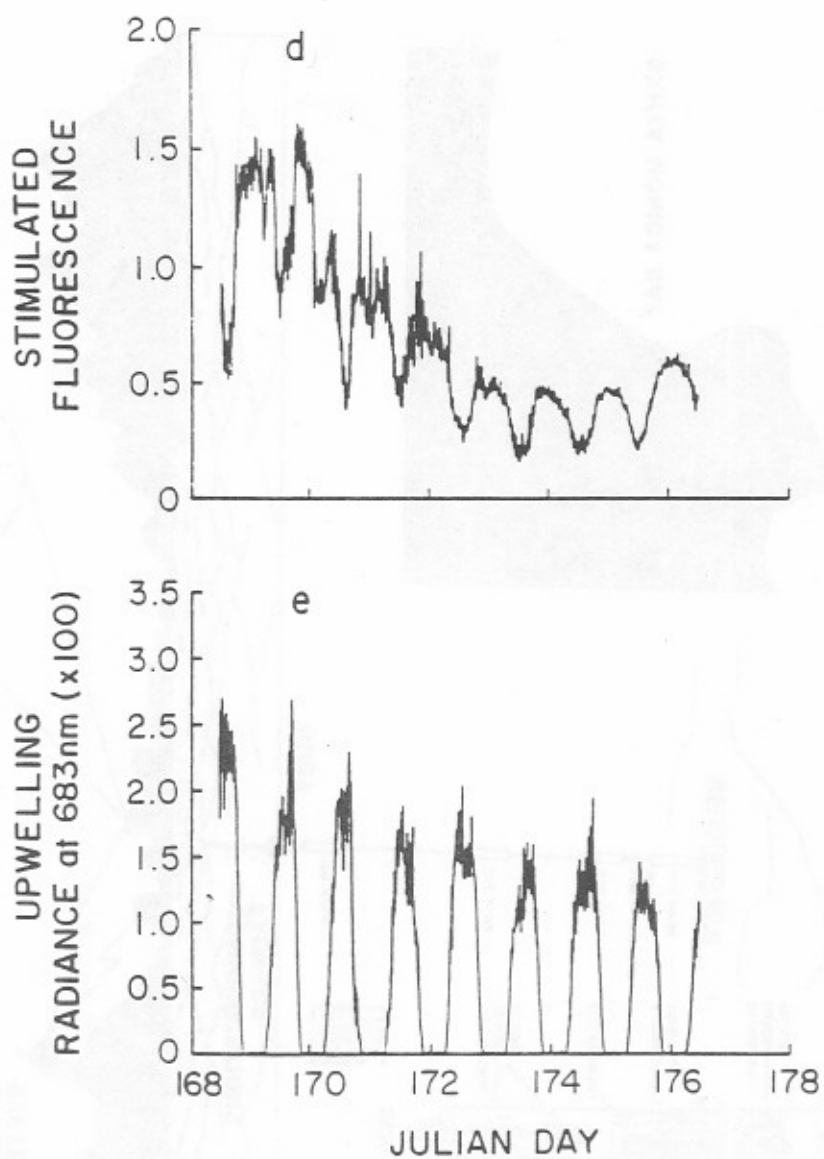

Figure 7. Time series of variables obtained from a Tri-Star drifter including (a) temperature ( $^{\circ}\text{C}$ ) (+ indicates measurements made with thermistor mounted in surface transmitter package), (b) downwelling spectral irradiance at 520nm in  $\text{mW cm}^{-2} \text{nm}^{-1}$ , (c) beam attenuation coefficient in  $\text{m}^{-1}$ , (d) stimulated chlorophyll fluorescence (volts), and (e) upwelling spectral radiance at 683nm in  $\text{W cm}^{-2} \text{nm}^{-1} \text{sr}^{-1}$  (after Abbott et al., 1990).



## DUPLEX COMMUNICATIONS EXPERIMENT

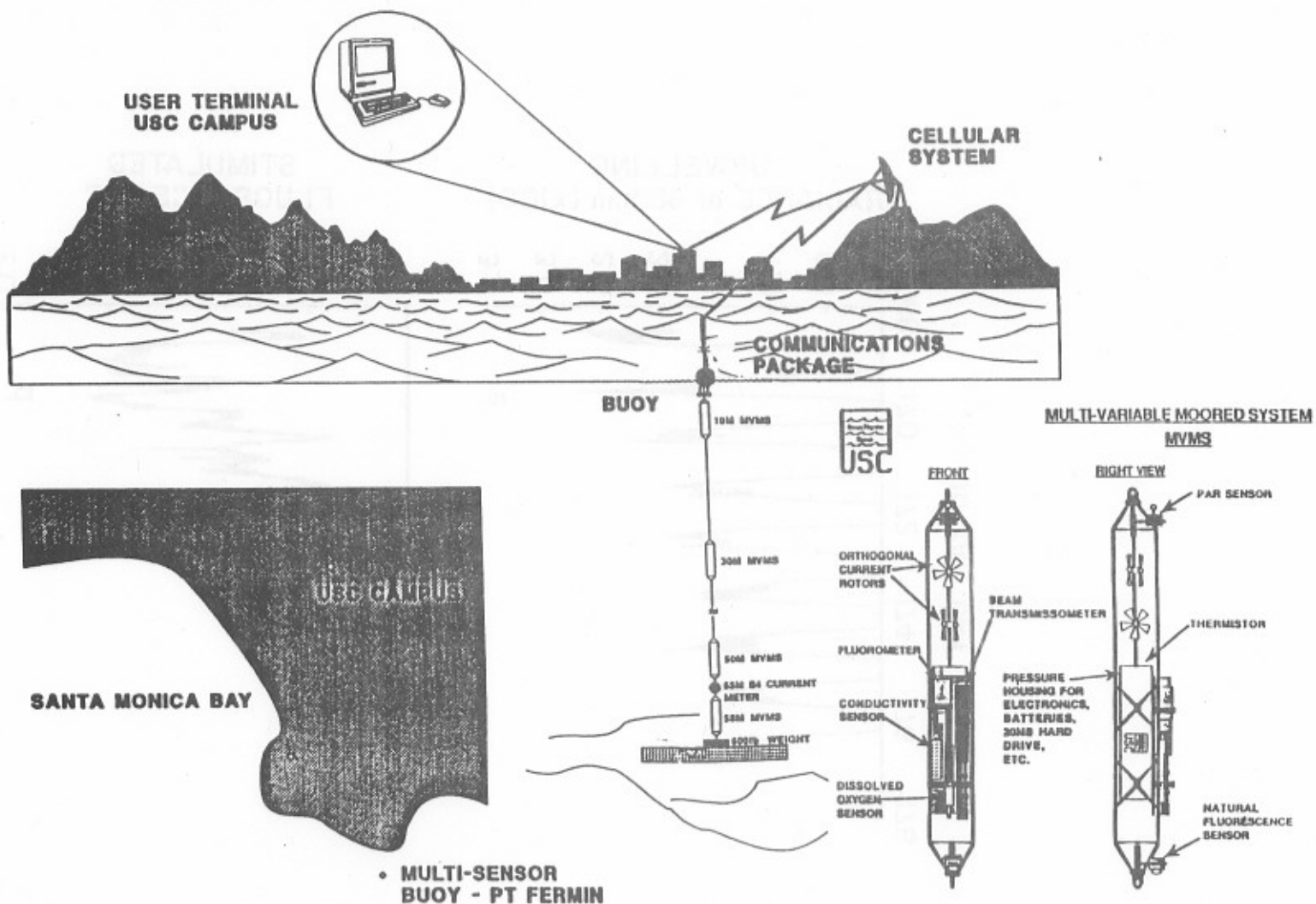

Figure 8. Schematic of interdisciplinary mooring study done off the coast of Los Angeles in 1991. The multi-variable moored system (MVMS) is shown bottom right. Data were recorded internally on disk drives and telemetered to shore (e.g., University of Southern California (USC) in January and February, 1992; see Fig. 9).

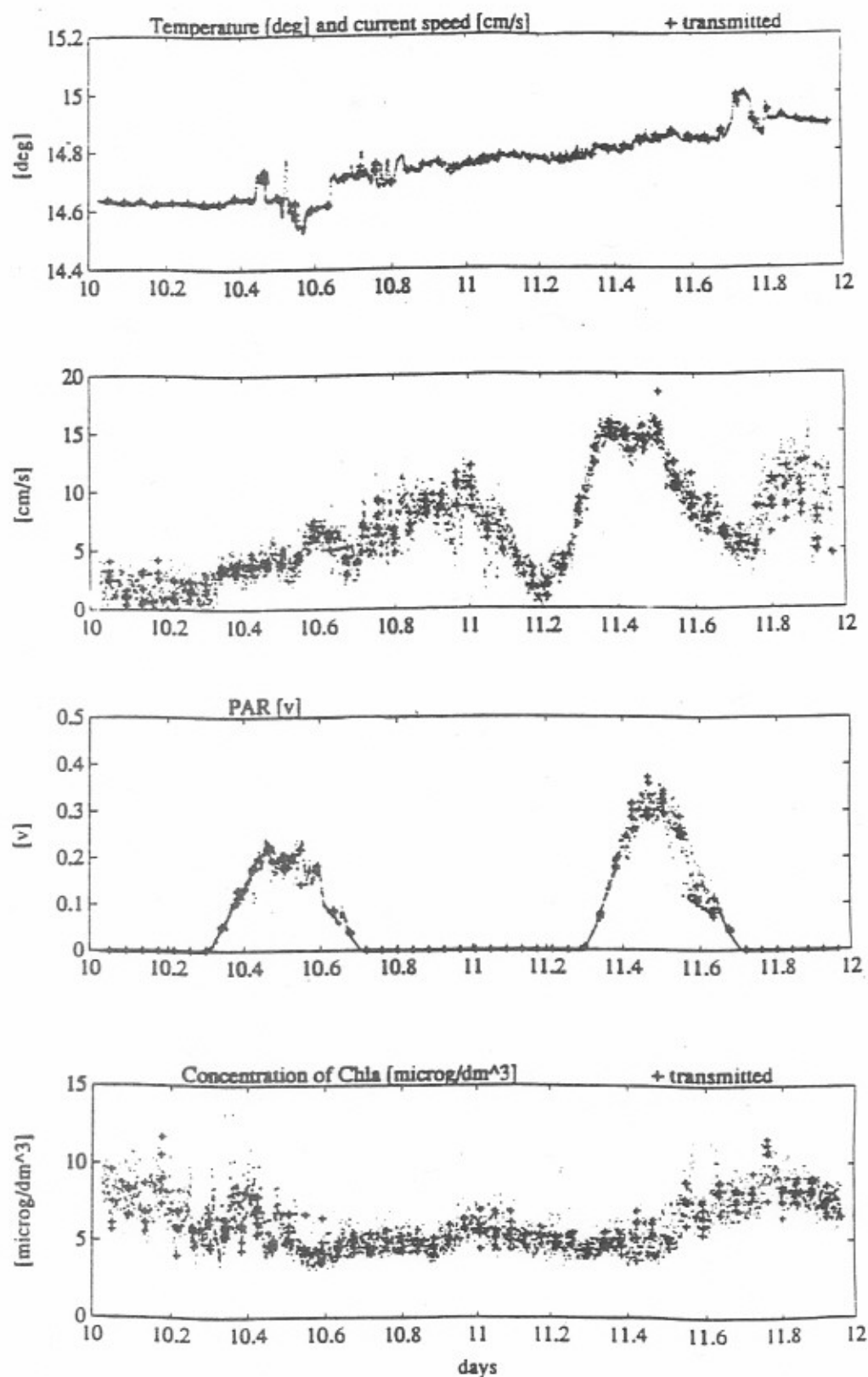

Figure 9. Time series data taken off the coast of Los Angeles (as shown in Fig. 8). Data shown are from the 10m MVMS (Fig. 8) during January 10-11, 1992. Variables (from top to bottom) include: temperature, current speed, photosynthetically available radiation (PAR), and chlorophyll fluorescence. Dots indicate data stored internally and crosses indicate telemetered data.

## **Wrap-Up Session**

---

*Convener - Geoffrey Holland*



## **Wrap-Up Session**

---

### **Convener Geoffrey Holland**

The Wrap-up session of the Workshop was convened by Mr. Holland who announced that rather than form a panel of a few participants this session would be open to all. The purpose of bringing them to the Workshop was to use their expertise in deciding how to proceed in the future. Since the great majority of attenders were at this session, there was an opportunity for a good discussion of all relevant topics. In some cases it was decided that the topics were too complex to be concluded at this Workshop and that further discussions among specialists is needed. Presented in this section is a summary derived from floor discussions. Although statements and recommendations are not attributed to individuals, the collaborative effort of this work is recognized.

A volume of the Proceedings of the OCDW will be prepared by the host country for distribution by the IOC (and others, if requested). The overall goal of establishing a dialogue between data managers and scientists was achieved. In addition, a number of issues were discussed. Many of these will require action by the IOC and other groups represented at the OCDW. These issues are listed in the order they were discussed (not prioritized or ranked) and are summarized below.

### **Issues**

#### **A. Continuing Liaison Between Data Managers and Scientists**

Listening to the case studies that were presented it became quite evident that the best data management systems were the ones where data managers and research scientists worked as a team developed in the early stages of project planning. Examples that were given included WOCE Data Assembly Centres e.g., Drifters, the Global Temperature Salinity Pilot Project (GTSP) collaboration with Joint Analyses Centres in the U.S. and Australia, and JGOFS/BOFS development of Topical Centres. While each of these has some elements unique to the project, each had brought together "teams" of Principal Investigators (PI's) and data management experts at an early stage of project development. Conversely, projects which had considered data management as a totally separate activity with lower priority often failed to provide the service required to meet scientific objectives. Therefore, the following actions should be brought to the attention of relevant groups within the IOC and other international organizations:

1. Publicize, at the national and international level, underway data/scientist collaborations that may be used as models in planning for the future.

2. Reduce adversarial situations where data managers and scientists appear to be in competition.
3. Colocation and other forms of collaboration often results in very high quality data sets and more timely data submission. Improved timeliness of data submissions was a common theme throughout the workshop and must be considered an important element in all future plans. Improvements in timely submission of data were noted. In order to continue this trend the advantages of timely submission of data must be stressed to those planning new ocean science projects.

### **B. Importance of Historical Data**

While the ocean climate related work that has been done to date has yielded significant results, it was apparent that there is a growing need to fill spacial and temporal gaps in the present data set. There is no other way to study long term ocean climate changes and the present global set is not adequate for all the work that needs to be done. At present there is an ongoing multilateral effort known as Data Archeology. The discussion on historical data highlighted the following issues:

1. There is a need to expand the current ad-hoc multilateral effort to an international data rescue and recovery project.
2. The support of member states is required for this work.
3. It has been demonstrated that cost-benefit is high. The cost of data recovery is quite small when compared to the initial cost of data collection, while the benefits accrued when using these data for global studies are quite dramatic.
4. Some of these data are in danger of being lost because of deterioration in their present state and an immediate rescue effort is needed.
5. Not only do the numerical values need to be recovered, but the auxiliary data (metadata) needs to be recaptured as well.
6. A continuously updated data set will require high quality historical data as well as contemporary observations.

### **C. Role and Importance of World Data Centers (WDC's)**

The consensus of OCDW participants was that the World Data Centers plays an important role internationally in the sharing of scientific data and information. Furthermore, that this role would increase in importance as global change problems such as climate change begin to grow in number and complexity. The following actions were recommended:

1. There needs to be a reexamination of the World Data Centre System's role and responsibilities in light of present plans for climate and global change experiments. For WDC's, Oceanography this is of special importance because of work currently underway in planning for a Global Ocean Observing System (GOOS).
2. WDC's A, B, & D for Oceanography should undertake a project to harmonize data holdings so that any data user, anywhere in the world, will know the total data available from the WDC's. It was understood that such a project has been started and workshop participants endorsed this work. In order to meet

requirements for more timely access to data, the oceanographic WDC's have begun a project to have a unified semi-annual catalogue available and, if possible, have this catalogue available on an electronic bulletin board.

3. The WDC's should continue to promote free access to data and a policy of freely exchanging data. The sharing of data is of growing importance to ocean climate programmes. In addition to traditional data types it was noted that satellite derived data or data products are of growing importance and working arrangements for access to these data should be investigated.
4. Although oceanography was of prime concern to workshop participants, it was recognized that ocean data is only part of the total system and that multi-disciplinary data sets will be need to be considered.

#### **D. Evolution of Data**

A full range of technical matters associated with the collection and dissemination of data and metadata were discussed. It was recognized that many of these items will require assembling, relatively small, expert groups who would make specific recommendations aimed at solving a particular problem. Issues under this subject include:

1. Problems associated with the increasing size of data sets:
  - Techniques for storage and retrieval of these data.
  - Study of compression techniques and of data products associated with these data sets.
  - Training of data managers in handling of large data sets
2. Increasing complexity of data
  - New data types especially in Chemistry and Biology
  - Growing importance of metadata and problems associated with the cost, formatting, storage and retrieval of this information.
3. Need for correlation of data sets across disciplinary lines.
  - Techniques for format interchange
  - Flexibility of data (and metadata) recording
  - Development of a common georeference system
4. Technical problems associated with the storage and retrieval of satellite-derived observations.
5. Development of an overall IOC strategy focussed on the orderly development of data systems required for an operational ocean observing system. This development must be done in cooperation with the WMO as well as other international bodies and might be the subject of another follow-on workshop.

#### **E. Participation of Developing Countries in Ocean Climate Programmes**

In discussing the ways in which developing countries might participate in research and operations associated with ocean climate projects, it was quite clear that some, if not all, developing countries cannot get the access they need to data and data products. Computer tools shown at the OCDW demonstrated that many tools are available today at very low cost. The problems are associated with getting hardware and software to the right place with adequate training to the users. The

Ocean-PC approach was noted with interest. The following summarizes issues that were addressed by participants:

1. Need for an improved dialogue between developing and developed countries. There is a need for ICSU to work with non-governmental organizations in developing countries in order to provide data access for these groups.
2. Supply of modern tools is important only if accompanied by training data.
3. Technology development has reached a point with CD-ROMs, user friendly software and low cost computers that the present situation should be eased considerably with the cooperation of member states.
4. Developing countries and regions should develop their own data management strategies in order to maximize technology and data access.
5. Developing countries should be asked to play a role in data rescue where data are available and need to be put in digital form.

#### **F. Model Data**

Discussion at the OCDW made it abundantly clear that air-sea interaction models and forecasting models are of growing importance to ocean climate projects. These models are both a user of data and a generator of data (or pseudo-data). This subject evoked enough discussion that it is an excellent candidate for a follow-on meeting sometime in the future. Issues that were discussed include:

1. Modelers need data input and generate data output. Output is now considered a research product but may be needed by others. Should it be archived, for how long, where?
2. Further discussion is needed on the usefulness and complexity of storing model output. Do you archive all model output or just selected products?
3. Should model output be considered as part of a data set or complementary to it?
4. How important is the metadata that accompanies model output and what should it contain?
5. There is a need to organize model generators & users in order to determine what is available, whether there is a need to exchange these internationally or only exchange information about models that are under development. This problem needs reconciliation by those directly involved.

#### **G. Data Quality**

The importance of data quality was a repeated theme in workshop talks and discussions. Many of the ongoing climate related projects e.g. WOCE, have very high quality standards. While some modelers may have ways of filtering data of lesser quality, others require data that has been fully processed and quality assured. Some of the issues discussed were:

1. Quality assurance must be developed in such a way that the best quality data are obtained without duplication of effort from the time data are acquired until they are made available for general dissemination. This will require full coordination throughout the process.

2. The GTSP was noted as an excellent example of how data centres and researchers may collaborate in order to produce a high quality data set available for the international community. This type of government-university collaboration to produce high quality data sets is encouraged.
3. While there is much to learn from the meteorological example, participants felt that oceanography does not have the "forecasting" base used by that community and must develop its own strategy for building data sets needed by climate change projects.

## **H. Funding**

There were a number of items related to how things would get done and how funding could be obtained to perform these tasks. This discussion was a wide ranging one and may be summarized as follows:

1. Oceanography has traditionally received research funds. As we move toward an operational system, how do countries receive funding for these operational systems, while still maintaining the strong research base that will be required? The OCDW could not answer this question, but was quite aware that it is critical to the future development of an observing system.
2. Other funding actions that were suggested:
  - Set up a trust fund within the IOC specifically for data management activities such as those proposed by this workshop.
  - Cosponsors should consider funding follow-on activities suggested in this report.
  - Member States should fund data archeology activities as noted in this report.
  - Bring national attention to the need for ocean monitoring. Also bring to national attention the need to match financial support of World Data Center's to their increasing responsibilities.

## **I. The Global Ocean Observing System (GOOS)**

While many of the items above contained elements related to GOOS, there were several points made that were specifically aimed at that programme. Speakers involved in the development of GOOS stated that a strong, effective data management programme is at the heart of a successful ocean observing system. It was also pointed out that GOOS requires coordination and interactions among a number of IOC groups and between IOC and a number of other international organizations such as WMO, SCOR, ICSU, and the UN Environmental Programme (UNEP). Some of the issues discussed were as follows:

1. There is a need to have a well staffed operations office with at least one member of that office responsible for coordination of data management activities.
2. GOOS will require an efficient communications system linking the observational network, data centres, and users.
3. A GOOS data management plan will need to take into account the fact that regional and global products will need to be disseminated in a timely fashion.
4. Standards will need to be adopted for all GOOS systems.

5. Some IOC elements that currently exist may need to be redirected into a coherent organization, serving GOOS.

## **J. Communications**

Concern was expressed over the adequacy of communication networks as required by both present research programs and potential monitoring activities. Workshop attendees suggested a study of the following items:

1. Interactive transfers of data collections.
2. International data networks which could link data centres.
3. Rapid data dissemination to users worldwide.
4. Investigate regulatory policies that may hinder the use of the wider bandwidths needed to carry out current and planned programmes.
5. All participants agreed that the electronic mail used widely by the oceanographic community has been, and will continue to be, an essential part of the international communication system.

## **V. Conclusion**

There seemed to be enthusiastic support for the concept of the OCDW. Comments received both publicly and privately were supportive of the form and substance of the meeting. The issues and actions cited above should provide very important guidelines to the IOC and other sponsors. Just as important as these recommendations is the bonding that occurred between data managers and scientists during the course of the OCDW. It should be noted that some of the data managers are also highly qualified research scientists and that this may set some sort of a trend. This workshop differed markedly from those where a data manager was invited to a science meeting, or where a token scientist was invited to a data meeting. This seemed to truly be an interaction where there was mutual benefit derived by most, if not all, participants. Although the workshop recommended a meeting like this one in 2-3 years, it is believed that too much was crammed into this first meeting and that the next should be more narrowly focussed with more specific recommendations. An example would be a workshop centered on the preparation of data sets that are required for experimental GOOS models. A number of other subjects are mentioned in the body of this report.

## **Appendix I**

The following is a reproduction of notes used by Roy Jenne of the U.S. National Center for Atmospheric Research.

### **Some Types of Data**

- An XBT in some reasonable format
- A grid in GRIB format
- A compressed pix of Mars at JPL
- A non-regular cloud grid

- A picture format on PC's
- A field of data in F 6.1 characters

What is common for all the above?

- Each is a string of bits
- The lengths usually vary
- each has a known structure

### Formats

- Organize the data for computers
- all users variables and precision

### What is the data sSituation?

- We have common formats—lots of them
- We have bright ideas on other formats - some of them
- There are simple formats - Need almost no learning time
- There are junk formats
- PIs make calculations
  - with models
  - with data
  - with both
- There are many data cultures
  - Groups with regular formats
  - Codes for Data Types e.g. COADS, NODC XBTs
  - GF 3
  - Bufr, GRIB
  - CDF, not CDF,HDF
  - DBMS (Oracle, Empress etc.)
  - SASS
- There are many display systems
  - Each has an internal structure
  - And display operators

### Data systems of the future

- Must handle some format diversity
- Don't make it hard for the PIs
- Users will choose their software
  - Some from various science groups
  - Some from commercial packages
- Users will use data for calculations

### New developments

- Format descriptions
- Translate on demand
- PC Formats - may make the de facto standard



## **Appendix I**

---

### ***Program***

**OCEAN CLIMATE DATA WORKSHOP**

Goddard Space Flight Center, Greenbelt, Maryland, USA

February 18 - 21, 1992

*A dialogue between data managers and scientists*

**Host** U.S. National Oceanic and Atmospheric Administration  
National Aeronautics and Space Administration

**Purpose** This workshop is intended to begin discussions which may lead to the improved data delivery systems that are needed by scientists studying the oceans role in climate change.

- Objectives**
- *Identify opportunities* for improving data management for ocean climate research;
  - Find ways to *improve access* to marine data;
  - Outline the characteristics of data management systems needed to *support ocean monitoring and prediction*;
  - Provide guidelines for *improved data services*.

**Audience** The workshop is primarily intended for those who are working on and planning ocean related climate projects. However, the workshop will welcome anyone with an interest in the subject matter.

**Publication** Proceedings of the workshop will be published and distributed to those attending. The proceedings will also be made available to sponsoring organizations for their distribution.

**Fees** Speakers and other invited guests will not be assessed any fees. Others who attend will be asked to pay a registration fee of \$75 which includes the proceedings and the evening seminar.

**Language** English only

**For Further Information Contact**

Intergovernmental Oceanographic Commission  
Attn: Youri Oliouline  
7 Place de Fontenoy  
75700 Paris, France  
Telephone: (33 1) 45 68 39 63  
Telemail: IOC.SECRETARIAT

or National Oceanographic Data Center  
NOAA/NESDIS E/OC22  
Attn: James Churgin  
1825 Connecticut Ave., NW  
Washington, DC 20235, USA  
Telephone: (202) 606-4571  
Telemail: J.CHURGIN or NODC.WDCA

**Hotel Accommodations**

A block of rooms has been set aside for the Workshop at the:

Courtyard by Marriott  
6301 Golden Triangle Drive  
Greenbelt, MD

Telephone: (800) 321-2211 or (301) 441-3311

Bus transportation from the hotel to the meetings will be available

**PROGRAM****OCEAN CLIMATE DATA WORKSHOP**

Goddard Space Flight Center, Greenbelt, Maryland, USA  
February 18 - 21, 1992

**February 18**

8:45-9:30am

**Registration**

9:30am - 12:30pm

GFC Building #3  
Auditorium**Introduction to the Workshop**

In addition to logistics of the workshop, speakers will talk about future programs related to understanding how the oceans affect climate and how climate changes affect the oceans.

*Subject*

Introductory remarks

The Constancy of the Ocean

Role of the Earth Observing System

Global Observations & Operational Oceanography:  
a Decade of Transition

The Role of Ocean Climate Data in Naval Oceanography

International Organization of Ocean Programs - Making  
a Virtue of NecessityWorld Ocean Climate Change Investigations under  
the "Sections" Programme

The Role of the WDC's in Handling Ocean Climate Data

*Speaker*

Sponsors and hosts

J. Knauss

S. Wilson

J. Baker

G. Chesbrough

A. McEwan

S. Gulev

F. Webster

12:30-2:00pm

**LUNCH**

2:00-3:20pm

GFC Building #3  
Auditorium**Computer Systems**

This session will include talks and hands-on demonstrations of new computer systems which are (or soon will be) available to oceanographers and others studying climate change and the oceans. The objective will be to familiarize attendees with these systems and to invite them to return individually or in small groups during the course of the workshop for a hands-on experience on these systems.

*Convener: L. Olsen*

3:30-5:30pm

GFC Building #26  
Room 205*Subject*

NASA's Climate Data System and its Evolution as

Goddard's Distributed Active Archive Center (DAAC)

SEAPAK An Oceanographic Analysis Software Package

Oceanographic Data Analysis in the Goddard Laboratory  
for Hydrospheric Processes

Project POSEIDON, the NODC On-line Database

ATlast for PC &amp; OceanAtlas for Macintosh

*Speaker*

L. Olsen

C. McClain

T. Busalacchi

P. Topoly

E. Smith

**February 19**

9:00am - 4:30pm  
GSFC Building #3  
Auditorium

**Monitoring Changes in the Ocean and Atmosphere**

The object of this day will be to look at what has been done, and what needs to be done to create data sets that can be useful to scientists who require data on a more timely basis.

*Convener: R. Wilson*

*Subject*

Operational Seasonal and Interannual Predictions of Ocean Conditions  
The World Circulation Experiment (WOCE)  
The Global Ocean Observing System  
Global Temperature Salinity Pilot Project  
Indian Ocean Analyses  
Monitoring Global Ocean Surface Variations  
The Use of Remotely Sensed Data for Operational Fisheries Oceanography  
Ocean PC and a Distributed Network for Ocean Data

*Speaker*

A. Leetmaa  
A. Clark  
D. Kester  
B. Searle  
G. Meyers  
D. Halpern  
A. de Fiuzza  
D. McClain

6:30pm/7:30pm  
GSFC Recreational  
Center

**COCKTAILS/DINNER**

*Guest Speaker: G. Holland*

**February 20**

9:00am - 1:00pm  
GSFC Building #3  
Auditorium

**Data Archaeology**

The objective of this session will be to demonstrate the usefulness of historical data. There will also be a panel discussion on other uses of historical data and on data sets that are not currently available to the international community.

*Convener: S. Levitus*

*Subject*

Ocean Climate Diagnostic Studies  
Satellite Altimetry  
High Resolution GCM Modeling of the Thermohaline Structure of the World Ocean  
Data Archaeology at ICES  
Data Availability and Data Archaeology from the Soviet Union  
Ocean Climate Data for the User Community in West and Central Africa; Needs and Opportunities

*Speaker*

S. Levitus  
R. Cheney  
A. Semtner  
H. Dooley  
Y. Sychev  
S.O. Ojo

2:00 - 6:00pm  
GSFC Building #3  
Auditorium

**Effect of Change in the Ocean and on the Life Cycle**

This session will include a case study of the 1989 N. Atlantic Bloom Study (NABE), as well as time-series operations and other programs related to biogeo-

chemical global change, from the perspective of the field scientist, analyst, modeler, and data manager. Different approaches to Data Management and Archiving of resulting studies will be included which we hope will stimulate a panel discussion on techniques to be considered. Discussion will also cover QC techniques and what can be done to improve input to analysts and modelers. The session will focus on chemical and biological data.

#### Introduction to JGOFS

*Convener: H. Ducklow*

##### *Subject*

Scientist's View of the NABE, a JGOFS Process Study  
 Data Management for JGOFS: Theory and Design  
 Data Management in the UK BOFS Program, a JGOFS  
 Case Study  
 Management and Assimilation of Satellite Data for JGOFS  
 The Continuous Plankton Recorder Survey: Long-term,  
 Basin-scale Oceanic Time Series  
 BATS and Station S: Time Series Operations in JGOFS  
 Automated Observations of Upper Ocean Biogeochemistry  
 and Optics for JGOFS

##### *Speaker*

H. Ducklow  
 G. Flierl  
 R. Lowery  
 R. Evans  
 J. Gamble  
 T. Michael  
 T. Dickey

#### February 21

9:00am - 12:00pm  
 GSFC Building #3  
 Auditorium

#### Wrap-up Panel

Representatives from each of the sessions plus some other speakers will form a panel to conduct discussions on recommendations to the IOC, WMO and other scientific groups conducting international data exchange and dissemination of data required for climate studies.

*Convener: G. Holland*

12:00 - 1:00pm

#### Closing Remarks

This will be a summing up of the Workshop.

*Convener: Chairman*



#### HOSTS:

U.S. National Oceanic Atmospheric Administration (NOAA)  
 U.S. National Aeronautics and Space Administration (NASA)



recycled paper

#### SPONSORS:

Commission of European Communities (CEC)  
 International Council for the Exploration of the Sea (ICES)  
 International Council of Scientific Unions (ICSU)  
 Intergovernmental Oceanographic Commission (IOC)  
 Scientific Committee on Oceanic Research (SCOR)  
 World Meteorological Organization (WMO)

## **Appendix II**

---

### ***Participants List***

Dr. N.R. Andersen  
National Science Foundation Marine Chemistry  
Program  
1800 G. ST., NW Washington, DC 20550  
E-MAIL: N.ANDERSEN/OMNET

Kevin R. Arrigo  
NASA/Goddard Space Flight Center  
Code 971  
Greenbelt, MD 20771  
PHONE: (301) 286-2128

D. James Baker, President  
Joint Oceanographic Institutions, Inc.  
1755 Massachusetts Avenue, NW  
Washington, DC 20036  
PHONE: (202) 232-3900  
E-MAIL: J.BAKER.JOI

Dorothy Bergamaschi  
Office of Marine Science & Technology  
OES/OA/MST, Room 5801  
Department of State  
Washington, DC 20520  
PHONE: (202) 647-0239  
E-MAIL: STATE.DEPT/OMNET

Murray Brown  
Minerals Management Service  
Mail Code 5430  
1201 Elmwood Park Boulevard  
New Orleans, LA 70123-2340  
PHONE: (504) 736-2901  
FAX: (504) 736-2610  
E-MAIL: M.BROWN.MMS (Omnet)

Anthony J. Busalacchi  
NASA/Goddard Space Flight Center  
Code 971  
Greenbelt, MD 20771

John Calder  
NOAA - OAR  
1335 East-West Highway  
Silver Spring, MD 20910  
PHONE: (301) 713-2465  
FAX: (301) 713-0666  
E-MAIL: J.CALDER (Omnet)

Russell Callender  
2909 Summerfield Road  
Falls Church, VA 22042  
PHONE: (202) 653-1604

Heidi Calvert  
NOAA/NESDIS/International Affairs  
Washington, DC 20233  
PHONE: (301) 763-4586  
FAX: (301) 736-5828  
E-MAIL: NESDIS.INTL (Omnet)

James Carton  
Department of Meteorology  
University of Maryland  
Space Sciences Building 2112  
College Park, MD 20742

Robert E. Cheney  
NOAA, National Geodetic Survey N/CG11  
11400 Rockville Pike  
Rockville, MD 20852  
PHONE: (301) 443-8556  
E-MAIL: NOAA.GEOSAT

RADM G. Chesbrough  
Oceanographer of the Navy  
US Naval Observatory  
34th and Massachusetts Avenue, NW  
Washington, DC 20392-1800

James Churgin  
5225 Pooks Hill Road, #113 South  
Bethesda, MD 20814  
PHONE: (301) 530-1931  
E-MAIL: (OMNET) J.CHURGIN

R. Allyn Clarke  
Bedford Institute of Oceanography  
Atlantic Oceanographic Laboratory  
P.O. Box 1006  
Dartmouth Nova Scotia B2Y 4A2 CANADA  
PHONE: (902) 426-2502  
E-MAIL: BEDFORD.INST

Peter Cornillon  
Graduate School of Oceanography  
University of Rhode Island  
Kingston, RI 02882

James Crease  
University of Delaware  
College of Marine Studies  
700 Pilottown Road  
Lewes, DE 19958  
PHONE: (302) 645-4240  
E-MAIL: (OMNET) J.CREASE

Michael Crowe  
WMO  
Geneva, Switzerland  
PHONE: 4122 730-8377  
FAX: 4122 734-2326

Tommy D. Dickey  
Ocean Physics Group  
University of Southern California  
Dept. of Geological Sciences, SCI 283  
Los Angeles, CA 90089-0740  
PHONE: (213) 740-6734  
FAX: (213) 740-8801  
E-MAIL: T.DICKEY

Harry Dooley  
International Council for Exploration of the  
Seas  
Palaegade 2-4  
Copenhagen K DK-1261 DENMARK  
PHONE: 45 93 11 71  
E-MAIL: ICES.D.K. (OMNET)  
OCEAN@SERVER.ICES.DK

Bruce C. Douglas  
NOAA/NOS  
Rockville, MD 20852  
PHONE: (301) 443-8858  
FAX: (301) 468-5714  
E-MAIL: NOAA.GEOSAT

Hugh Ducklow  
Horn Point Marine Laboratories  
University of Maryland  
Cambridge, MD 21613  
PHONE: (301) 228-8200  
E-MAIL: (OMNET) H.DUCKLOW

William Erb  
Office of Marine Science & Technology  
OES/OA/MST  
Room 5801  
Department of State  
Washington, DC 20520

David L. Eslinger  
NASA/Goddard Space Flight Center  
Code 971  
Greenbelt, MD 20771  
PHONE: (301) 286-2141  
FAX: (301) 286-2171  
E-MAIL: dave@petrel.gsfc.nasa.gov

Robert Evans  
Rosentiel School of Marine & Atmospheric  
Sciences  
University of Miami  
4600 Rickenbacker Causeway  
Miami, FL 33149-1098  
PHONE: (305) 361-4799  
E-MAIL: R.EVANS/OMNET

M. Fiadeiro  
Office of Naval Research  
Physical Oceanography Program  
Code 1122PO  
Arlington, VA 22217  
PHONE: (703) 696-4441  
E-MAIL: M.FIADEIRO (Omnet)

Dr. Armando F.G. Fiuzza  
Departamento de Fisica/Centro de Geofisica  
Faculdade de Ciencias da Univeridade de  
Lisboa  
Rua da Escola  
Politecnica, 58 1200 Lisboa, Portugal  
PHONE:(351-1) 397-0891  
EMAIL: FCOCPNBO@PTEARN.BITNET

Nic Flemming  
Inst. of Oceanographic Sciences  
Deacon Laboratory  
Wormley Godalming Surrey GU8 5UB,  
UNITED KINGDOM  
E:MAIL: (OMNET) N.FLEMMING

G.R. Flierl  
Ctr for Meteorology & Physical Oceanography  
Massachusetts Inst of Technology  
Bldg. 54, Room 1426  
Cambridge, MA 02139  
PHONE: (617) 253-4692  
E-MAIL: glenn@pimms.mit.edu

Mike Fraser  
NMFS/NOAA  
1335 East-West Highway  
Silver Spring, MD 20910  
PHONE: (301) 713-2372  
FAX: (301) 588-4853  
E-MAIL: M.FRASER (Omnet)

Dr. John Gamble  
The Hardy Foundation  
Plymouth Marine Laboratory  
Plymouth, UNITED KINGDOM

Linda K. Glover  
Office of the Oceanographer of the Navy  
US Naval Observatory  
34th and Massachusetts Ave.,NW  
Washington, DC 20392-1800

Peter Grimm  
1825 Connecticut Ave, NW  
Washington, DC 20235  
PHONE: (202) 606-4509  
FAX: (202) 606-4586  
E-MAIL: (Decnet) NODC::GRIMM

Elizabeth Gross  
Johns Hopkins University  
Dept of Earth & Planetary Science  
Baltimore, MD 21218  
PHONE: (410) 516-4070  
FAX: (410) 516-7933  
E-MAIL: (Omnet) E.GROSS.SCOR

Sergey K. Gulev  
State Oceanography Institute  
Hydrometeorology Committee of Russia  
Kropotkinsky per., 6  
Moscow, 119838, USSR  
PHONE: (095) 2467089, 2467288  
FAX: (095) 2467288 2012383  
TELEMAIL: 411117 RUMS SU 411968 OKEAN  
SU  
OMNET: GULEV.BOBA

D. Halpern  
Jet Propulsion Laboratory  
MS 300-323  
4880 Oak Grove Drive  
Pasadena, CA 91109

Douglas Hamilton  
1825 Connecticut Ave, NW  
Washington, DC 20235  
PHONE: (202) 606-4636  
E-MAIL: NODC.WDCA



Richard Hayes  
Office of the Oceanographer of the Navy  
US Naval Observatory  
34th and Massachusetts Ave., NW  
Washington, DC 20392-5101  
PHONE: (202) 653-1604  
E-MAIL: OCEANAV

George Heimerdinger  
NOAA Liaison Office  
Woods Hole Oceanographic Institution  
Mclean 114  
Woods Hole, MA 02543

Geoffrey Holland  
Director-General Physical & Chemical Sci  
Directorate  
Dept. of Fisheries and Oceans  
200 Kent Street, 12th Floor  
Ottawa Ontario K1A 0E6 CANADA  
PHONE: (613) 990-0298  
FAX: (613) 990-5510  
E-MAIL: OCEANSCIENCE.OTTAWA

David Irvine  
HUGHES STX/NSSDC Project  
7601 Ora Glen Drive, Suite 300  
Greenbelt, MD 20770  
PHONE: (301) 513-1677  
E-MAIL: NCF::IRVINE (Decnet)

Gregory Isayev  
305 West Side Drive, Suite 204  
Gaithersburg, MD 20878  
PHONE: (202) 606-4411

Melanie Jenard  
NOAA/NOS  
1825 Connecticut Ave, NW  
Suite 615  
Washington, DC 20235  
PHONE: (202) 606-4178  
FAX: (202) 606-4059  
E-MAIL: NOS.IA

Roy Jenne  
National Center for Atmospheric Research  
(NCAR)  
P.O. Box 3000  
Boulder, CO 80307-3000  
PHONE: (303) 497-1215  
E-MAIL: R.JENNE (Omnet)

Cdr. John A. Jensen  
Commander, Naval Oceanography  
Command (N31)  
Stennis Space Center, MS 39529  
PHONE: (601) 688-5748  
FAX: (601) 688-5332

Lt. Cdr. David Jones  
Navy/NOAA Joint Ice Center  
4301 Suitland Road, FOB #4  
Washington, DC 20395-5180

Michael Jugan  
Naval Oceanographer Office  
Code OP  
Stennis Space Ctr, MS 39522-5081  
PHONE: (601) 688-4424

Tom Kaneshinge  
NOAA/GP  
1335 East West Highway  
Silver Spring, MD 20910

Dana Kester  
Office of the Chief Scientist  
Universal Bldg., Room 625  
1825 Connecticut Avenue, NW  
Washington, DC 20235  
PHONE: (202) 606-4243  
E-MAIL: D.KESTER (Omnet)

John Knauss  
Under Secty for Oceans and Atmosphere  
Department of Commerce  
National Oceanic & Atmospheric Admin.  
Washington, DC 20230

Chet Koblinsky  
NASA/Goddard Space Flight Center  
Code 971  
Greenbelt, MD 20771  
PHONE: (301) 286-2880  
FAX: (301) 286-2717  
E-MAIL: C.KOBLINSKY (Omnet)

Dieter Kohnke  
Bundesamt fur Seeschifffahrt und  
Hydrographie  
Bernhard-Nocht-Strasse 78  
Postfach 30 12 20  
D-W2000 Hamburg 36 GERMANY  
PHONE: 49-40-3190 3400  
FAX: 49-40-3190 5000  
E-MAIL: D.KOHNKE (Omnet)

Michail Krasnoperov  
WMO  
Geneva, Switzerland  
PHONE: (4122) 730 8111  
FAX: (4122) 734 2326

Gunnar Kullenberg  
Intergovernmental Oceanographic Commission  
UNESCO  
7 Place de Fontenoy  
75700 Paris, FRANCE  
PHONE: 33-1-456 83983  
E-MAIL: G.KULLENBERG

Pablo Lagos  
NOAA, OGP  
1335 East-West Highway  
Silver Spring, MD 20910  
PHONE: (301) 427-2089  
E-MAIL: OMNET: P.LAGOS

Ants Leetmaa  
NOAA/National Meteorological Center  
Climate Analysis Center  
5200 Auth Road, W/NMC52  
Washington, DC 20233

Sydney Levitus  
NOAA/NODC E/OC2  
1825 Connecticut Avenue, NW  
Washington, DC 20235  
PHONE: (202) 606-4411  
E-MAIL: (OMNET) S.LEVITUS

Marlon Lewis  
Department of Oceanography  
Dalhousie University  
Halifax, Nova Scotia B3H 4J1 CANADA  
PHONE:(902) 494-3557  
E-MAIL: (OMNET) M.LEWIS

Roy Lowery  
Proudman Oceanography Laboratory  
Bidston Observatory  
Bidston Birkenhead Merseyside L43 7RA  
UNITED KINGDOM

Ibrahim A. Maitya  
Head, ENODC  
National Institute of Oceanography & Fisheries  
Kayet Bay, Alexandria EGYPT  
PHONE: (203) 801 174  
E-MAIL: OMNET.BADAWI

Capt. C. Martinek  
Office of the Oceanographer of the Navy  
US Naval Observatory  
34th and Massachusetts Ave.,NW  
Washington, DC 20392-1800

George M. Mason  
5111 Lawson Avenue  
Gulfport, MS 39507  
PHONE: (601) 688-4275

Rob Massom  
NASA/Goddard Space Flight Center  
Code 971  
Greenbelt, MD 20771  
PHONE: (301) 286-3548  
E-MAIL: MASSOM.OCEAN1.GSFC.NASA.GOV

Charles McClain  
NASA/Goddard Space Flight Center  
Lab for Hydrospheric Processes Code 971,  
Bldg. 22, Room 266  
Greenbelt, MD 20771  
PHONE: (301) 286-5377  
E-MAIL: OMNET/C.MCCLAIN

Angus McEwan  
CSIRO Division of Oceanography  
Marine Laboratories  
Castray Esplanade, G.P.O. Box 1538  
Hobart Tasmania 7001 Australia  
PHONE: 61 02 206212  
E-MAIL: A.MCEWAN/OMNET

Douglas McLain  
NOAA NOS/OAB  
2560 Garden Road  
Monterey, CA 93940  
PHONE: (408) 647-4212  
EMAIL: OAG.MONTEREY.OMNET

Nikolai N. Mikhailov  
Oceanographic Data Centre  
Russia Research Institute of Hydrometeorologi-  
cal Information  
6, Korolev Str.  
Obninsk, Kaluga, 249020 USSR  
PHONE: 2 56 78  
FAX: (095) 2552225

Gary Meyers  
CSIRO Division of Oceanography  
Marine Laboratories  
Castray Esplanade, G.P.O. Box 1538  
Hobart Tasmania 7001 Australia  
PHONE: 61 02 206208 E-  
MAIL:OMNET.G.MEYERS

A. Michaels  
Bermuda Biological Station  
Ferry Reach  
St. Georges Bermuda  
PHONE: (809) 297-1880  
E-MAIL: A.MICHAELS/OMNET

Yutaka Michida  
Japan Oceanographic Data Center (JODC)  
Hydrographic Department  
5-3-1 Tsukiji  
Chuo-Ku Tokyo 104 JAPAN  
PHONE: 81 3 3741 3811  
E-MAIL: T.MORI/OMNET

Gary T. Mitchum  
TOGA Sea Level Center  
University of Hawaii  
1000 Pope Road, MSB-317  
Honolulu, HI 96822

Dr. Christina Myles-Tochko  
Johns Hopkins Applied Physics Lab.  
Johns Hopkins Road  
Laurel, MD 20723  
PHONE: (301) 953-6603

T. Nelson  
Office of Naval Research  
Physical Oceanography Program  
Code 1122PO  
Arlington, VA 22217

Professor S. O. Ojo  
University of Lagos  
Fac. of Enviro. Sciences/Geography Dept.  
Lagos, NIGERIA  
PHONE: 01 820696/01 820281

Youri Olioumine  
Intergovernmental Oceanographic Commission  
UNESCO  
7 Place de Fontenoy  
75700 Paris, FRANCE

Lola Olsen  
NASA/Goddard Space Flight Center  
Code 934.0, Room W158, Bldg. 28  
Greenbelt, MD 20771  
PHONE: (301) 286- 9760

Richard B. Olsen  
SATLANTIC  
3295 Barrington Street  
Richmond Terminal Pier 9  
Halifax, N.S. CANADA B3K 5X8  
PHONE: (902) 492-4780  
FAX: (902) 492-4781  
E-MAIL: OMNET:M.LEWIS

Bruce Parker  
National Ocean Service, NOAA  
6011 Executive Boulevard  
Rockville, MD 22071  
PHONE: (301) 443-8691  
FAX: (301) 443-1920  
E-MAIL: B.PARKER/OMNET

Irving Perloth  
1825 Connecticut Avenue, NW  
Washington, DC 20235  
PHONE: (202) 606-4598  
E-MAIL: I.PERLROTH

Capt. John Pfeiffer  
Office of the Naval Deputy, NOAA  
Dept. of Commerce  
Hoover Building, Rm. 6003  
14th & Constitution Avenue  
Washington, DC 20230-0001  
PHONE: (202) 377-8355

Joel Poitevin  
METEO FRANCE  
Chef of the Sea Weather Forecast  
42 Av. Gustave Coriolis  
31057 Toulouse Cedex FRANCE  
PHONE: 33 61-07-82-90  
FAX: 33-61-07-82-32

Jean-Paul Rebert  
TOGA Subsurface Data Center  
Centre ORSTOM BP 70  
29780N Plouzane FRANCE  
PHONE: 33 98 22 45 13  
FAX: 33 9822 45 14  
E-MAIL: ORSTOM.BREST

Mike Reeve  
Oceans Sciences Division  
Room 609  
National Science Foundation  
Washington, DC 20550  
PHONE: (202) 357-9600  
E-MAIL:M.REEVE/OMNET

H. Thomas Rossby  
Graduate School of Oceanography  
University of Rhode Island  
South Ferry Road  
Narragansett, RI 02882  
PHONE: (401) 792-6521  
FAX: (401) 792-6728  
E-MAIL: T.ROSSBY/OMNET

Stanley Ruttenberg  
Univ. Corp. for Atmospheric Research  
P.O. Box 3000  
Boulder, CO 80307-3000  
PHONE: (303) 497-8689  
E-MAIL: S.RUTTENBERG/OMNET

Cdr. S. Sandgathe  
Office of Naval Research  
Physical Oceanography Program  
Code 1122PO  
Arlington, VA 22217

Jean Schiro-Zavela  
NOAA/NESDIS/International Affairs  
Washington, DC 20233  
PHONE: (301) 763-4586  
FAX: (301) 736-5828  
E-MAIL: J.SCHIRO.ZAVELA/OMNET

Ben Searle  
Australian Oceanographic Data Center  
P.O. Box 1332  
North Sydney N.S.W. 2059 Australia  
PHONE: 61 2 925 4230  
E-MAIL: B.SEARLE

Albert J. Semtner  
Department of Oceanography  
Naval Postgraduate School (NPGS)  
Monterey, CA 93943-5000  
PHONE: (408) 646-3267  
E-MAIL: SBERT@NCAR.UCAR.EDU

Mitchell Shank  
Naval Oceanographic Office  
Stennis Space Center, MS 39522  
PHONE: (601) 688-4561

Lin Shaohua  
c/o NOAA/NODC E/OC2  
1825 Connecticut Avenue, NW  
Washington, DC 20235

V. Smirnov  
Oceanographic Data Centre  
Russia Research Institute of Hydrometeorologi-  
cal Information  
6, Korolev Str.  
Obninsk, Kaluga, 249020 USSR  
PHONE: 546 39 10

Cdr. Brad Smith  
Navy/NOAA Joint Ice Center  
4301 Suitland Road, FOB #4  
Washington, DC 20395-5180

Elizabeth Smith  
Jet Propulsion Laboratory  
MS 300-323  
4880 Oak Grove Drive  
Pasadena, CA 91109

Thomas Spence  
National Science Foundation  
Ocean Sciences Division  
1800 G. ST., NW  
Washington, DC 20550

Yuri Sychev  
Oceanographic Data Centre  
Russia Research Institute of Hydrometeorologi-  
cal Information  
6, Korolev Str.  
Obninsk, Kaluga, 249020 USSR  
PHONE: (08439) 25907  
FAX: (095) 2552225

Mr. Jan Szaron  
Swedish Meteorological & Hydrological Inst.  
P.O. Box 2212  
S-40314 Gothenburg SWEDEN  
PHONE: 96 31 630393

Wendy Tang  
Jet Propulsion Laboratory  
4800 Oak Grove Drive  
Pasadena, CA 91109  
PHONE: (818) 354-8199  
FAX: (818) 393-6720  
E.MAIL:WFT@PACIFIC.JPL.NASA.GOV.

Shin Tani  
Japan Oceanographic Data Center  
Hydrographic Department  
5-3-1 Tsukiji  
Chou-ku Tokyo 104 JAPAN  
PHONE: 011 81 3 5565 7080  
E-MAIL: T.MORI/OMNET

Peter Topoly  
NOAA/NODC E/OC3  
1825 Connecticut Avenue, NW  
Washington, DC 20235

Capt. Adolfo Villanueva  
Servicio de Hidrografia Naval  
Av. Montes de Oca 2124  
1271 Buenos Aires ARGENTINA  
PHONE: 54 01 21 0061 67 ext. 59  
FAX: 54 01 21 7797

Michelle M. Walrod  
Naval Oceanographic Office  
Stennis Space Center, MS 39522  
PHONE: (601) 688-5176  
FAX: (601) 688-5154

D.N. Wambura  
Marine Meteorological Service  
Directorate of Meteorology  
P.O. Box 3056  
Dar Es Salaam, Tanzania  
PHONE: 32601

Ji Wang  
National Ocean Service, NOAA  
Rockville, MD 22071  
PHONE: (301) 443-8691  
FAX: (301) 443-1920

Ferris Webster  
University of Delaware  
College of Marine Studies  
700 Pilottown Road  
Lewes, DE 19958  
PHONE: (302) 645-4266  
E-MAIL: F.WEBSTER/OMNET

Hou Wenfeng  
Mao Bin National Oceanographic Data Center  
73 Liuwei Road, He Dong District  
Tianjin, 300171 PEOPLE'S REPUBLIC OF  
CHINA  
PHONE: (022) 315213

Ron Wilson  
MEDS, Dept. Fisheries & Oceans  
200 Kent Street  
Ottawa, Ontario CANADA K1A 0E6  
PHONE: (613) 990-0264  
FAX: (613) 990-5510  
E-MAIL: R.WILSON.MEDS

Stanley Wilson  
NOAA/NOS  
1825 Connecticut Ave. NW  
Room 611  
Washington, DC 20235

Gregory Withee  
NOAA/NESDIS  
1825 Connecticut Avenue, NW  
Washington, DC 20235  
PHONE: (202) 606-4089  
E-MAIL:G.WITHEE

Charles Wooldridge  
NOAA/NESDIS/International Affairs  
Washington, DC 20233  
PHONE: (301) 763-4586  
FAX: (301) 736-5828  
E-MAIL: C.WOOLDRIDGE/OMNET

Rear Admiral Austin J. Yeager  
Director, Coast and Geodetic Survey  
N/CG, WSE1  
Washington Science Center, WSC1  
Room 1006  
6001 Executive Boulevard  
Rockville, MD 20852  
PHONE: (301) 443-8204

**Appendix III**

---

## **International Ocean Services Is It Time - Will It Ever Be Time?**

---

*Geoffrey Holland*

Considering the objectives of the Ocean Data Climate Workshop this week and trying to select a related, but not too technical subject, I decided to look at the services needed for ocean clients. I thought that it would make an interesting theme to consider how the acceptance of international ocean services is progressing over the years. Or is it? Are we closer to having a global observing system than we were twenty years ago? If so, what has changed between then and now? What is different between the efforts of twenty years or so ago to get the Integrated Global Ocean Stations System (IGOSS) off the ground and the present attempts to establish the Global Ocean Observing System (GOOS)? Is there a window of opportunity now that didn't exist then? If it doesn't happen now, a legitimate question could well be asked.... Will it ever happen?

At least on historical topics I am on firm ground, having been attending IOC meetings for many years, in fact, it was in 1970 that I attended my first IGOSS meeting and a couple of years later I started what was to become regular attendances at the IOC Governing Body sessions. Despite the numbing effect of sitting through IOC related meetings for a total of what must add up to two or three years, I can still defend the IOC as an essential intergovernmental body for the oceans. One can accept the value of medicine, but one doesn't have to enjoy the taste!

Looking back on the discussions taking place at earlier times, for example, when IGOSS was still in the pilot project phase, there were already strong advocates for ocean monitoring and ocean services, trying to convince governments of the benefits of a global approach to ocean services. Many of the arguments made then could be lifted straight out of the text and used today. As part of my preparations for tonight, I dug into the reports of the early IOC Assembly meetings, they make fascinating reading.

Although I was looking mainly for references related to the development of ocean service products, I couldn't resist noting some of the more general items that evoked a "then and now" response, either because things had changed dramatically or not at all.

Right from the report from the first ever session of the IOC in 1961, some problems never seem to go away. One resolution noted the shortage of experts in marine sciences, which.... "may well delay the development of these sciences for many years". Another resolution urged increased support to developing countries interested in participating in international oceanographic programs.

Some actions showed considerable foresight, a resolution on aids to navigation recommended..... "the active pursuit of satellite navigation". In fairness to history however, I should point out at that time, satellite navigation was qualified as a system of lesser accuracy in the context of plus or minus a quarter of a nautical mile in positioning.

As far as ocean observations were concerned, the Acting Director General of Unesco, in his opening address, stated that...."scientists felt more and more the need for numerous, detailed and systematic observations". A great deal of discussion was directed towards the exchange of data and the need to standardize methodology and formats.

The foundations for future global ocean observations were definitely laid at the first meeting. The first IOC Chairman was Anton Bruun, who unfortunately passed away later the same year. Also at that first session in 1961, the US delegation numbered 28 and China was represented by Taiwan. The need to concentrate research efforts on ocean circulation was mentioned as early as the next year, when one of the resolutions instructed..... "the Secretary to call special attention to Member States to the need for the quickest possible development of the technical means for the study of the oceanic circulation". The 1962 session was convinced of the importance to develop a comprehensive program for world ocean study as a framework under which national, regional and world-wide international programs for the ocean could be planned. Japan argued for speedy distribution and utilization of synoptic data, and a plea went out to fishing organizations for the systematic collection of ocean data on all fishing vessels.

It was in 1962, that SCOR was recognized as an advisory body to the IOC. That year, an IOC meeting in Washington recommended the acceptance and use of the metric system for ocean observations. The Commission took a breather in 1963 and met again in 1964. This meeting recognized the...."intimate relation between the atmosphere and ocean and the probable effect of global forces and events on the balance of heat and transport of water in the ocean. IGOSS was stirring, as the IOC, led by Jim Snodgrass of Scripps, discussed the need to allocate radio frequencies for ocean data use.

In 1964, in his welcoming address, the Director General of Unesco stated his intent to increase the IOC budget by 27%. France complained about the lack of translation for many of the meeting documents. In 1965 the Commission established a Working Group on Ocean-Atmosphere Interaction to cooperate with similar groups being set up by WMO, and the IUGG. The WG was to consider ways in which intergovernmental action could strengthen the forecasting of sea surface conditions and to facilitate the exploitation of marine food resources. Professor Matveyev, Assistant Director General for Science told the participants that the number of problems requiring international solutions was sure to increase and that, even if one day, the Commission succeeded in covering the whole ocean with a network of systematic observations, it would still have tasks to fulfill. The Integrated Global Ocean Station System, IGOSS, was established as an IOC

Working Group in 1967 at the Fifth Session. The Commission itself recommended a budget increase of 50%, to allow inter alia, the development with WMO, of synoptic ocean data systems. It also noted the need to coordinate the work of the various WGs on Data Exchange, Ocean Data Stations, Communications, Ocean Variability and Air-Sea Interactions, with a view to preparing the ground for the eventual establishment of synoptic ocean observation in the oceans.

By this time membership of the IOC had risen to 58 Member States and the number in the US delegation had fallen to fourteen delegates, plus six observers. Progress on the planning for IGOSS was reported to the Sixth Session of the IOC in 1969. Concurrently with this session, IGOSS and the WMO Panel on Meteorological Aspects of Ocean Affairs had its second joint meeting. The Commission adopted the General Plan and Implementation Program for IGOSS, Phase I. In so doing the resolution noted the connection between the call from the UN General Assembly for an expanded program of world-wide exploration of the oceans and the need for improved data collection and processing. The resolution also emphasized the need for more detailed studies on applications and user requirements. Therefore by, the end of the sixties, IGOSS was established but not underway, links between the IOC and WMO had been set and the importance of global ocean observations had been recognized by oceanographers. Requirements and applications were not very well argued. In all, the situation was not too much different to the present except for the absence of the climate factor.

In 1971 the political bickering on representation continued. A resolution by the Executive Council of Unesco eventually resolved the China issue. It was at this session that the Commission decided to separate the IOC from the Office of Oceanography, and also started its preoccupation with its own Rules of Procedure, Statutes and Organization. The entry of the Commission into the seventies was also marked with a flurry of additions to the growing list of acronyms. GELTSPAP, the Group of Experts on the Long-term Scientific Policy and Planning made its report on LEPOR, the Long-term and Expanded Program of Oceanic Research. The International Decade of Ocean Exploration IDOE was adopted as part of the plan. ROSCOP was adopted, GIPME was established. The publication on International Marine Science was founded and the IOC also issued an inventory of "ODAS of the World". ODAS referring to Ocean data Acquisition Systems. In terms of ocean services, the Commission approved the Bathy Pilot Project and therefore launched IGOSS implementation, and decided that pollution monitoring was a responsibility of the IOC, however it couldn't decide on where to place that responsibility.

It was in 1973, during a discussion on GATE (GARP Atlantic Tropical Experiment and FGGE (First GARP Global Experiment) that "climate changes" appeared for the first time. Professor Kort of the USSR drew attention to the role of ocean currents in the meridional transfer of heat and "...the probable importance of this transfer to long-term weather forecasting and climate changes". Also in 1973, a workshop on El Niño was called for, IGOSS priorities were endorsed. On the political front Algeria objected to the presence of Portugal, South Africa and Rhodesia, the IOC input into the Law of the Sea took up much of the discussion,



the number of Member States to the IOC had risen to 76 and the US delegation had shrunk to 12.

By the mid-seventies ocean services under IGOSS had become respectable, if not as widely supported as one would have liked. The Bathy Pilot project became operational, several manuals and guides were published. The marine pollution (petroleum) monitoring project MAPMOP was implemented. FAO called on IGOSS to look to the provision of ocean services for the fisheries. South Africa narrowly survived a suspension of their participation at the end of the Assembly in 1975, only to be removed at the commencement of the tenth Assembly in 1977.

In 1977 the IOC was made aware of the growing issue of climate. A Joint SCOR/IOC Committee on Oceanography and Global Atmospheric Research Program, called COG and chaired by Henry Charnock, linked the importance of ocean circulation models to climate. The Assembly heard of the establishment of the World Climate Program, which went beyond GARP objectives and felt that the IOC should participate extensively in these activities as the oceanographic role became more evident. The annual number of BATHY/TESAC messages exchanged under IGOSS hit 35,000 in 1976. Codes were established to allow data from ocean buoys to be added to the observational network. IGOSS reviewed its support for GARP and climate activities. The IOC Committee for IGOSS was abandoned in favour of a Joint Working Committee with the WMO. Interest in ocean services was widely expressed, although participation of Member States remained limited.

By the end of the seventies, programmes identified as being "of fundamental concern to the Commission" included ocean climate and marine resources. One of the successes of the end of the decade was FGGE. WMO reported to the Commission that all the planned oceanographic programs during FGGE had been successfully completed. Of special mention was the drifting buoy program under IGOSS. During FGGE in 1979, 260 ships from 21 countries contributed to the 45,000 BATHY/TESAC reports received. 360 drifting buoys were deployed and their data coordinated through IGOSS. This demonstration of IGOSS usefulness marked a certain maturation and consolidation of ocean observation and services over the decade. The end of the seventies saw the establishment of the Joint IOC/SCOR Committee on Climate Change and the Ocean CCCO and the beginning of the planning for the World Ocean Circulation Experiment WOCE. The link between climate and ocean observations was cemented by Roger Revelle addressing the Assembly, as Chairman of CCCO. With typical clarity he outlined the future requirements. For ocean monitoring from the standpoint of climate, he stated there are four considerations to be borne in mind: data accuracy, data coverage, data timeliness and economy of data retrieval. Ocean pollution monitoring activities were transferred from IGOSS to GIPME.

So into the eighties. In 1982 the IOC Assembly preceded the opening of the Law of the Sea Convention by a few weeks. Climate had become a focus for many of the ocean science programmes. An action plan was presented by the CCCO for

an Ocean Observation System which called for the implementation of observation programmes tested and designed through the CCCO and operated by IGOSS. IGOSS changed its name to the Integrated Global Ocean Services System and began to accept delayed mode (up to 30 days) data. 1985 was the twenty fifth anniversary of the IOC, and the Ocean Processes and Climate committee met for the first time. Priorities for ocean observations were stated as sea level, ocean buoy developments and IGOSS sub-sea thermal measurements. IGOSS identified four accelerated thrusts - ocean observation system development, data products, real-time sea-level data and technological improvements. Despite much rhetoric and a universal acceptance of the importance of ocean data and services, the lack of global participation continued to plague the full realization of its potential. Member States of the IOC itself now numbered 112, and the reverse correlation with the size of the USA delegation, now at ten, continued.

At the 1987 Assembly, ocean observations received much, if somewhat fragmented, attention. Discussions took place under agenda items on Oceans Dynamics and Climate, IGOSS, Buoy Coordination Panel, Global Sea Level Observations, IODE, Ocean Processes and Climate, GIPME, JGOFS (which made its first appearance at the Assembly, future requirements for ocean monitoring and a number of other of issues dealing with regional and other international bodies. The eighties concluded with the Fifteenth Assembly in 1989. By this time the climate priority in ocean monitoring was completely established. Under the JSC/CCCO the Ocean Observing System Development Panel was formed to give the scientific direction to the design of an observing system for climate needs. On a broader front the Assembly approved the establishment of an ad hoc group of experts to look at the organizational side of monitoring networks. To say that global ocean services has been a slow starter would be an understatement. In many respects the situation at the start of the nineties has not changed significantly from that in the sixties. In my view there are two major differences:

- i) the appearance of climate change as an issue, together with its obvious need for improved quantity and quality ocean data is the most significant factor.
- ii) the other relates to technological improvements, which are continuing to ease the task of gathering and analyzing the observations. Remote sensing, automation and the development of new and sophisticated instruments, such as doppler radar current meters will increase the quantity and reliability of observations. Concurrently computer hardware and software development are making the access, quality control and interpretation of these data more effective and economical.

The rationale for global ocean services as an aid to coastal development, fisheries, marine pollution, transportation, safety and offshore operations remains unchanged from the sixties. Of course the demands from the climate factor is an added requirement. The framework has been established and the technologies have progressed remarkably, but the same issues remain. Why is it that the problems of participation, commitment and continuity persist? I would suggest that the following were to blame in the sixties and they are equally true today:

- the lack of a strong operational secretariat
- the absence of dependable operational funding
- the need for better demonstration of benefits

Firstly, the lack of a strong operational secretariat. An effective operational global observation system cannot be run with a couple of positions at the IOC and little additional support. Admittedly the implementation must rely on national efforts and budgets, but an active operational unit is needed to solve issues in real-time, induce countries to meet commitments and deadlines and to give advice on all aspects of the system on a daily basis.

Over the eighties there seemed to be a fragmentation of the services sector within the Commission with programs on climate, GOOS, IGOSS, GLOSS, Drifting Buoys, IODE, ITSU and even pollution monitoring all on parallel but separate tracks. At the same time it was clear that programs of data management under the real-time IGOSS and the non-real-time IODE were converging. I feel that the IOC would be more effective in the area of ocean observation and services if it would consolidate the relevant programs. Although data and information from research programs must continue to be a part of an effective observational system, it cannot rely on the availability and direction of research programs alone if it is to survive, which brings me to the second obstacle - the absence of operational funding.

Government funding for operational systems needs to be consistent and dependable and therefore be separated from research projects, which tend to be variable and finite. With a see-saw of budgets and priorities it is difficult to maintain program momentum.

Can we convince our respective governments to put ocean observations on a regular and priority footing? I believe the answer is yes, but it won't be an easy sell. We must be able to explain.... what is to be done.....why we must do it.... and what are the expected results and benefits, all in words that an intelligent but possibly non-scientific person can understand.

Governments must also understand the benefits of ocean observation and services. One answer may be to look to demonstration projects and applications research. The Pacific TOGA has set a standard by planning the transition from research to operation. Many of the governments directly affected by the El Niño are already fully convinced of the need for predictions. I would guess a TOGA in the Indian Ocean would prove to be equally rewarding. The same reasoning could be applied to other areas such as fisheries or coastal zone management. I am sure projects exist or could be implemented that could serve as demonstration of benefits for similar problems in other areas. About eighteen months ago, Canada hosted a Symposium on Operational Oceanography for Fisheries, the response was tremendous.

The oceans make up a large part of our world, it is unthinkable that mankind will be able to solve the economic and environmental crises facing society today without an adequate knowledge of the oceans. Waiting will mean the loss of valuable climatic data and an increase in costs and complexity. The ocean community should act now.

**Appendix IV**

---

## Computer Systems

---

### **Convener - Lola Olsen**

In addition to the discussions, Ocean Climate Data workshop hosts gave participants an opportunity to hear about, see, and test for themselves some of the latest computer tools now available for those studying climate change and the oceans. Six speakers described computer systems and their functions. The introductory talks were followed by demonstrations to small groups of participants and some opportunities for participants to get hands-on experience. After this familiarization period, attendees were invited to return during the course of the Workshop and have one-on-one discussions and further hands-on experience with these systems. The following are brief summaries or abstracts of introductory presentations.

### **NASA's Climate Data System (NCDS)**

#### **Lola Olsen**

Ms. Olsen subtitled her presentation, "NCDS and Its Evolution as Goddard's Distributed Active Archive Center (DAAC)". She described the data flow and noted that a new interface had been installed. This interface allows communications directly with the database. NCDS also has direct access to data from the metadata. She described how a search is performed and various features of the system. The system uses the Common Data Format (CDF). This saves time, space, allows for portability and the inclusion of metadata along with the data, and eases comparisons among data sets. Procedures for verification were described. Examples were given as to what a user might find when performing a search and analysis of data. Finally, the results of the most recent version of NCDS have shown a boost in research productivity (in both the volume and quality). The system provides a feedback loop and maintenance has decreased. Future plans call for project support to various climate related projects, development of CD-ROMs, and evolution within the Goddard Distributed Active Archive Center (DAAC) of the Global Change Data Center for the Earth Observing System Data and Information System (EOSDIS).

Systems Data and Information System (EOSDIS), and eventually becoming a Global Change Data Center.

## **Oceanographic Data Analysis in the Goddard Laboratory for Hydrospheric Processes**

**Anthony J. Busalacchi**

Dr. Busalacchi described the large number and variety of ocean climate analyses that are being performed by NASA's Laboratory for Hydrospheric Processes. The work he discussed and illustrated included GEOSAT topography and other altimetric analyses. Surface winds and wind stress analyses from SSM/I were shown, as well as analyses using historical data such as COADS. Ocean color work originally developed using Nimbus 7/Coastal Zone Color Scanner (CZCS) data were shown and they are now preparing for the SEAWIFS satellite which is scheduled to be launched in 1993. A number of analytical projects in the higher latitudes were described including polar processes work on sea ice and surface temperature and ice thickness from radar altimetry data. A number of these applications were then demonstrated at the hands-on session that followed the talk. Climate ocean analyses conducted at Goddard include both global and basin scale studies - some observational, some modeling and may be interconnected through the computer systems demonstrated.

## **SEAPAK, An Oceanographic Analysis Software Package**

**Charles McClain**

SEAPAK consists of some 280 programs in a menu-driven system. It was originally designed to operate in a VAX/VMS environment, but there is now also a PC version called PC-SEAPAK. This system was designed for analysis of Coastal Zone Color Scanner (CZCS) imagery and can also be used to process AVHRR images. The system contains an extensive on-line data base of world wide meteorological and oceanographic data. The Transportable Applications Executive (TAE) interface used is "user friendly". All programs are written in Fortran. The system, which is hardware dependent, uses the International Imaging Systems (IIS) Model 75 display system. SEAPAK is now being ported to the UNIX environment. The PC version was written for a 386/20 and can process both CZCS and AVHRR data. A number of analysis tools were described, illustrated and later demonstrated. The VAX-based system operates on a large number of data sets and is very flexible. Collaborative efforts with NCDS in acquiring and translating data into a common format were cited as a key component in research productivity.

## **Project POSEIDON, the NODC On-Line Database**

**Peter J. Topoly**

The U.S. National Oceanographic Data Center (NODC) has under development a relational database system for in-situ marine biogeochemical parameters. The system is intended to replace the mainframe-oriented NODC master files. The first phase of this development, Project POSEIDON, is being undertaken to demonstrate the capabilities and possibilities of such a system. The first prototype was completed in 1991. POSEIDON has been developed using a client-server architecture consisting of a DEC VAX cluster and a Teradata 700 data base engine. The relational model used to store, manage, and access data is a simple approach keyed to individual marine data parameters. Each parameter is keyed or linked to other parameters by a complex, yet straightforward, set of metadata. There is nothing particularly unique about the POSEIDON database model. What separates POSEIDON from other systems is the philosophy behind its development. The POSEIDON database is not being implemented as an application, but rather as a fast powerful data supplier to other applications. A graphical user interface system, PEGASUS, is the link between the database and the user. This interface is being developed in three phases: an internal LAN version for NODC data management; a network version for Internet and dial-in access; and a stand-alone version for personal computers and workstations. The latter implementation, coupled with a POSEIDON database on a CD-ROM, will provide the climate researcher with a powerful, yet simple desktop tool. Beta testing of PEGASUS will begin in the spring of 1992.

## **A Microcomputer World Ocean Atlas of Hydrography, Nutrients and Chemical Tracers for the IBM PC AND Macintosh**

**Peter Rhines and Elizabeth Smith**

The oceanographic atlas is one of the main tools of the oceanographer (Stommel and Fieux, 1978). Paper atlases have long been used at sea to provide a context for newly acquired hydrographic sections, but these atlases are limited in their presentation. *Atlas*, for the IBM PC, and *OceanAtlas*, for the Macintosh II, are microcomputer applications which provide a simple means for browsing and manipulating hydrographic and tracer data using widely available hardware. *Atlas* was developed by Professor Peter Rhines (School of Oceanography, University of Washington), and *OceanAtlas* was developed from the IBM PC version by John Osborne (NOAA/PMEL) and James Swift (Scripps Institution of Oceanography).

Both application allow one to load oceanographic sections into a memory and plot them as "stacked" vertical profiles with superimposed color contouring of a second variable. The sections may then be browsed; plotting of individual stations or arbitrary subsets of stations, moving up and down moving up and down a



single cast to look at numerical values, or watching the inner construction of contemporaneous property plots. A variable size map window, with a plot of the cruise track, is visible at all times. Section plots may be reshaped or sized to highlight a particular feature.

The Macintosh and IBM PC versions are each unique in certain ways. The IBM PC version allows a customized section to be constructed by tagging stations from any number of sections, sorting the results and writing a new disk file. This new section may then be plotted. A much improved user interface graces the Macintosh version. Both versions allow new sections to be imported into the application specific format by means of a utility provided with the package.

Atlant is distributed on 5/3.5" high density diskettes with a User's Guide and includes approximately 100 sections. It requires an IBM-class microcomputer with CGA, EGA, or VGA graphics capabilities. An 80386-based IBM clone is ideal but an IBM-AT class machine is adequate.

OceanAtlas is distributed on 2/3.5" double density diskettes with a User's Guide and includes approximately 50 sections. It requires a Macintosh computer with 68020 or 68030 microprocessor and a color monitor which can display at least 16 colors. An SE30 with an auxiliary color monitor works fine, as will any of the Macintosh II family. Both packages are available, at no cost, from the JPL Physical Oceanography Archive Center. Please contact us at the addresses listed below. Atlant and OceanAtlas are both available free-of-charge from the JPL Physical Oceanography Distributed Active Archive Center. Please contact the Archive Center at: Mail Stop 300-320 Jet Propulsion Laboratory 4800 Oak Grove Drive Pasadena, CA 91109 Attention: Ruby Lassanyi Phone: (818)354-0906 Fax:(818)393-6720

## **GRADS - A New System for Data Analysis**

### **James Kinter**

Dr. Kinter described and demonstrated a tool for analysis of meteorological and oceanographic data that has recently been developed at the University of Maryland. The Grid Analysis and Display System (GRADS) has been designed to operate on four dimensional gridded data sets or on station data (both oceanographic and meteorological stations). The system allows for spacial and temporal filtering. Charts, maps, or animations may be displayed. The system uses X-Windows and may be used on a variety of workstations.

**SEAKPAK Vugraphs**

***SEAPAK***

***An Oceanographic Analysis Software Package***

by

Charles R. McClain

Oceans & Ice Branch  
Laboratory for Hydrospheric Processes  
NASA/Goddard Space Flight Center

# SEAPAK

## Satellite & In-Situ Data Analysis Package

- VAX-SEAPAK (GSFC only)

- 10 Years of Development
- Over 275 Analysis Programs
  - CZCS & AVHRR satellite data

*Ingest, calibrate, process level-2, project, register, average*

- Hydrographic data (e.g. NODC station data, Levitus climatologies, drifters)  
*Mean profiles, vertical & horizontal sections, density computations, etc.*
- Meteorological data (e.g. FNOC winds, NDBC mooring data)  
*Wind stress, Ekman upwelling, Sverdrup transport, streamlines etc.*
- Over 50 data sets on-line (CDFs & VMS index files)
- Statistical Analysis & Math Transformations  
*Freq. distributions, EOF's, MEM transforms, arithmetic functions, etc.*

- PC-SEAPAK (distributed)

- CZCS & AVHRR Analyses Only
- 115 Analysis Programs in Menu

- UNIX-SEAPAK (under development)

# SEAPAK

## Major Program Categories

1. Level 1 tape ingestion
2. Level 2 processing
3. Environmental data processing
4. Projection and registration
5. Graphics overlaying
6. Image data retrieval
7. Image arithmetic functions
8. Image statistics
9. IIS image processing
10. General utilities
11. DSP system support

## SEAPAK Functionality

- Image and Overlay Graphics Manipulation.
  - Image : save, restore, looping, editing, rescaling, false color and color bar generation.
  - Overlays : annotate, area-of-interest (blotches).
- Image File Manipulation.
  - Interactive data display and extraction.
  - Gray-level to geophysical value conversion.
  - ASCII image data generation.
  - Image merging.
- Geographic Programs.
  - Support twenty different projections.
  - Image registration.
  - Coastlines and grids and labels on an image.

## SEAPAK Functionality

- Level-1 Data Ingestion.
  - NOAA or NASA/GSFC CRT tape format for CZCS.
  - NOAA/NESDIS LAC and GAC tape formats for AVHRR.
  - Subsampling or duplicating of pixels.
  - Consecutive full resolution scene ingestion.
  - Interactive extraction from full resolution scene.
  - Output files : image files, control point file and log file.
- CZCS Level-2 Data Processing.
  - Level-2 products :
    - Subsurface water radiance at 443, 520 and 550 nm.
    - Aerosol radiance at 670 nm.
    - Rayleigh radiance at 443 nm.
    - Diffuse attenuation at 490 nm.
    - Pigment concentration.
  - Flexible algorithm and parameter selections.

## SEAPAK Functionality

- Mathematical Programs.
  - Arithmetic and logarithm functions.
  - Time series and scattergram plots.
  - Statistics : histogram, power spectrum analysis, autocorrelation and cross correlation.
- Ancillary Data Set Processing.
  - Ingest data into indexed or CDF format.
  - Interactive query for data extraction and listing.
  - Plotting : vector plot, X/Y plot, time series, contours, profiles, maps.
  - Image generation.
- Utilities.
  - Miami DSP file format support.
  - Color hard-copy on HP PaintJet printer.
  - Non-standard SEAPAK image file display.

## SEAPAK ANCILLARY DATA

- O Approx. 100 independent parameters supported
- O On-line query by parameter, program, file name
- O Gridded data in NASA Common Data Format (CDF)
  - Model outputs: FNOC, ECMWF, NMC winds, NOAA SST
  - Climatologies: Hellerman stress, COADS, Levitus mixed layer depths, Southern Ocean atlas
  - Fields experiments: FGGE winds, ISCCP clouds
- O Ungridded data in VAX/VMS indexed files
  - NODC products: stations, current meters, XBT
  - Field experiments: Sequal/Focal Nansen cast, FGGE drifters
- O Software capabilities
  - Gridded fields: SEAPAK images, contour/vector maps, time series at a point, ASCII lists
  - Ungridded fields: profiles, sections, OA, maps, lists
  - Interfaces: GEMPAK, Surfer/Grapher, spreadsheets



## User Interface

### VAX SEAPAK – Transportable Applications Executive (TAE)

- Developed at GSFC; used by many other applications.
- Menu and command modes.
- On-line help; save and restore of input parameters.
- Batch job submission and access to DCL.
- Supports variety of computers and systems.

### PC-SEAPAK – TAE-like interface

- Extracted from GSC's PCGEMS and enhanced by GSC.
- Menu and command modes.
- On-line help; save and restore of input parameters.

## Transportable Applications Executive

- Developed at GSFC; used by many other systems such as GEMPAK, LAS.
- Provides uniform interface to all SEAPAK programs.
- Menu and command modes for program invocation and data entry.
- Tree structure of menus allows efficient organization of a large number of programs.
- Dynamic parameter menus and prompting.
- Parameter values may be saved for easy recall.
- Allows access to operating system.
- Interactive, asynchronous, or batch execution of programs.
- On-line help for all commands, programs, and input parameters.
- Repetitive commands may be automated.

## Image Display System

### VAX SEAPAK – International Image System (IIS) Model 75

- Interlaced display.
- Sixteen 512x512x8 bits channels
  - 14 for images, 2 for graphics.
- Eight independent and non-destructive overlay graphics planes.
- Red, green and blue LUTs for each channel.
- Programmable hardware controlled track ball cursor.
- Keypad (15 function keys) and foot pedal.
- Hardware functions : pan, scroll, zoom, windowing, arithmetic operations, histogram, and convolution.

## Image Display System

### PC-SEAPAK – Matrox MVP-AT board

- Interlaced and non-interlaced display.
- Four 512x512x8 bits frame buffers
  - 3 for images, 1 for graphics.
- Seven non-independent and non-destructive overlay graphics palettes.
- Red, green and blue LUTs for each frame buffer.
- No hardware cursor support.
- Hardware functions : pan, scroll, zoom, windowing, arithmetic operations, histogram, and convolution.

## PC-SEAPAK System Configuration Example

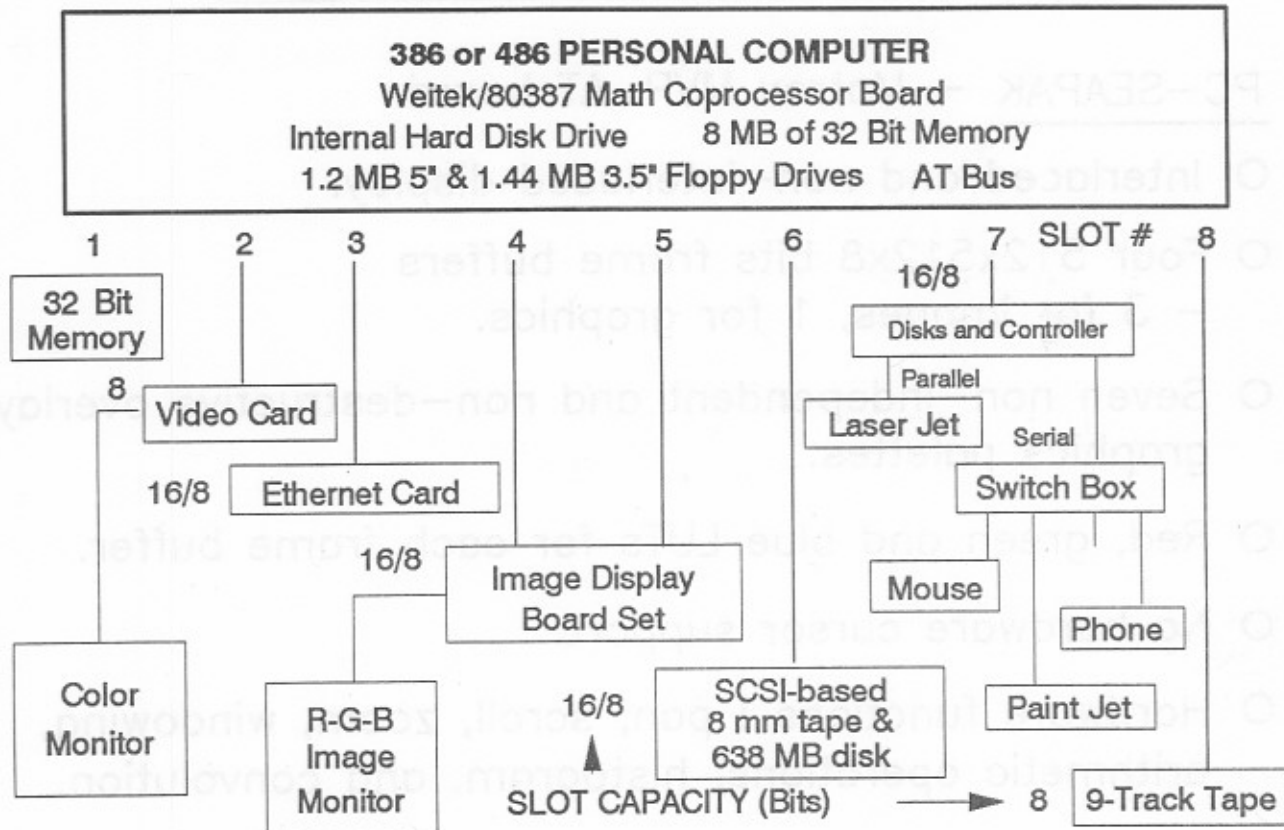

## PC-SEAPAK SITES

(SITES WITH FULL HARDWARE/SOFTWARE CONFIGURATIONS)



### U.S. SITES

WHOI	UMD	USM	USC
URI	ODU	SIO	OSU
UPa	USF	NOAA/SW Fish.	SAIC/Seattle
BNL	NOARL	JPL	ERIM

## SEAPAK TECHNICAL BIBLIOGRAPHY

Darzi, M., J. Chen, J. Firestone, and C. McClain, SEAPAK: A satellite image analysis system for oceanographic research, Proc. Fifth Internat. Conf. Interactive and Inform. Processing Systems for Meteorol., Oceanogr. and Hydrol., Am. Meteorol. Soc., Anaheim, Jan. 29 - Feb. 3, 26-32, 1989.

Firestone J., G. Fu, J. Chen, M. Darzi and C. McClain, PC-SEAPAK: A state-of-the-art image display and analysis system for NASA's oceanographic research program, Proc. Fifth Internat. Conf. Interactive and Inform. Processing Systems for Meteorol., Oceanogr. and Hydrol., Am. Meteorol. Soc., Anaheim, Jan. 29 - Feb. 3, 33-39, 1989.

McClain, C. R., J. Chen, M. Darzi, J. Firestone and D. Endres, SEAPAK Users Guide, Version 1.0, NASA Tech. Memo 100728, Natl. Aero. and Space Admin., Goddard Space Flight Center, Greenbelt, MD, 594 pp., 1989.

Firestone, J. K., G. Fu, M. Darzi and C. R. McClain, NASA's SEAPAK software for oceanographic data analysis: An update, Proc. Sixth Internat. Conf. Interactive and Inform. Processing Systems for Meteorol., Oceanogr. and Hydrol., Am. Meteorol. Soc., Anaheim, Feb. 5 - 9, 260-267, 1990.

Fu, G., M. Darzi, J. Firestone and C. R. McClain, SEAPAK: a comprehensive oceanographic analysis software system, Conf. Proc., Science and Techno. for a New Oceans Decade, Mar. Techno. Soc., Washington, D.C., Sept. 26-28, 527-532, 1990.

Darzi, M., J. K. Firestone, G. Fu, E. Yeh and C. R. McClain, Current efforts regarding the SEAPAK oceanographic analysis software system, Proc. Seventh Internat. Conf. Interactive and Processing Systems for Meteorol., Hydrol. and Oceanogr., Am. Meteorol. Soc., New Orleans, Jan. 14-18, 109-115, 1991.

Firestone, J. K., M. Darzi, G. Fu, E. Yeh and C. R. McClain, Oceanographic data analysis with NASA's SEAPAK software, Proc. ACMS/ASPRS/Auto Carto 10 Convention, Baltimore, March 25-29, 145-161, 1991.

McClain, C. R., M. Darzi, J. Firestone, E.-Y. Yeh, G. Fu and D. Endres, SEAPAK Users Guide, Version 2.0, NASA Tech. Memo. 100728, Vol. I--System Description, 158 pp., Vol. II--Descriptions of Programs, 586 pp., Natl. Aero. and Space Admin., Goddard Space Flight Center, Greenbelt, MD, 1991.

McClain, C. R., G. Fu, M. Darzi and J. K. Firestone, PC-SEAPAK User's Guide, Version 4.0, NASA Tech. Memo. 104557, 408 pp., Nat'l Aero. and Space Admin., Goddard Space Flight Center, Greenbelt, MD, 1992.